



订购说明/How to order

在选择接插件时，需确定 When selecting heavy duty connector,we need to choose as follow:

额定电压/电流	Rated voltage and current
回路数(接插件针数)	Poles of connector
外壳形式(防护外壳上壳及底座的选择)	Choosing hood and housing type
附件(主要为电缆接头的选择)	Accessories(selecting cable gland)

接插体型号说明/Inserts explanation

例：HE-016-M为HE系列的16针公插体。  
i.e: HE-016-Means male insert of 16 poles in HE series.

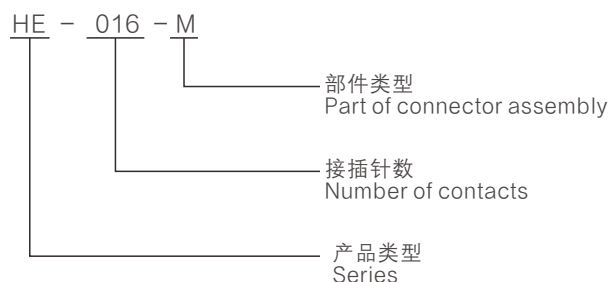

- M/F: 公/母螺钉连接 Male/Female Screw terminal
- MC/FC: 公/母冷压连接 Male/Female Crimp terminal
- MS/FS: 公/母弹片连接 Male/Female Cage-clamp terminal
- MSS/FSS: 公/母双弹片连接 Male/Female Cage-clamp terminal (two terminal per contact)
- MZ/FZ: 直插式弹片连接 Quick lock terminal

/Type of hoods and housings

例：H16B-SE-2B-M25为H16B外壳系列里侧出线的螺纹尺寸为M25的上壳  
i.e: H16B-SE-2B-M25 means a side entry hood with M25 thread in H16B series.

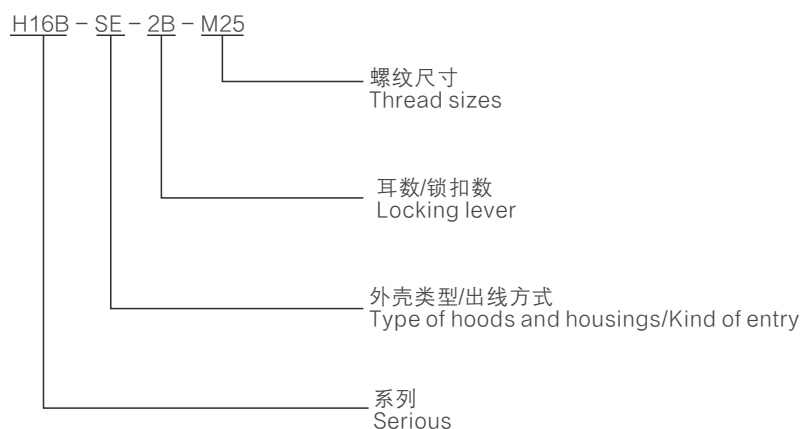

- SE: 上壳侧出线 side entry
- SEH: 上壳侧出线高结构 side entry,high construction
- TE: 上壳顶出线 top entry
- TEH: 上壳顶出线高结构 top entry,high construction
- BK: 不封底下壳 bulkhead mounting
- SF: 封底下壳 surface mounting
- SFH: 封底下壳高结构 surface mounting,high construction
- CCT: 飞线下壳 cable to cable
- CCTH: 飞线下壳高结构 cable to cable,high construction

公司产品包装默认为单个配件独立包装，如客户需组装完毕整体包装，请提前告知。  
Company products are packaged by default for individually packaged, if you need the overall package, please let us know in advance.

客户定制产品，请直接与我司联系For customize requirement,please contact us.



产品目录 Contents

**芯子部分 Inserts**

HA系列/HA Insert series	P01-01~P01-05
HE系列/HE Insert series	P02-01~P02-07
HEE系列/HEE Insert series	P03-01~P03-10
HD 系列/HD Insert series	P04-01~P04-11
HDD系列/HDD Insert series	P05-01~P05-08
HSB系列/HSB Insert series	P06-01~P06-05
HK系列/HK Insert series	P07-01~P07-20
HEAV系列/HEAV Insert series	P08-01~P08-05
HM系列/HM Insert series	P09-01~P09-37
HQ系列/HQ Insert series	P10-01~P10-16

**外壳部分 Hoods and housings**

3A外壳/Size 3A Hoods/Housings	P11-01~P11-10
10A外壳/Size 10A Hoods/Housings	P12-01~P12-02
16A外壳/Size 16A Hoods/Housings	P13-01~P13-02
32A外壳/Size 32A Hoods/Housings	P14-01~P14-02
6B外壳/Size 6B Hoods/Housings	P15-01~P15-10
10B外壳/Size 10B Hoods/Housings	P16-01~P16-13
16B外壳/Size 16B Hoods/Housings	P17-01~P17-21
24B外壳/Size 24B Hoods/Housings	P18-01~P18-22
32B外壳/Size 32B Hoods/Housings	P19-01~P19-06
48B外壳/Size 48B Hoods/Housings	P20-01~P20-02
HC外壳HC Hoods/Housings	P21-01~P21-08

**冷压针部分Crimp contacts**

5A 10A 16A 40A 70A 100A 200A	P22-01~P22-04
------------------------------	---------------

**附件 Accessories**

编码 Coding pins	P23-01~P23-01
附件/框架Accessories/ frame	P24-01~P24-02
工具 Removal Tool	P25-01~P25-02
电缆接头 Cable glands	P26-01~P26-15



外壳防护等级 Ingress Protection

连接器上的外壳，密封件及锁扣装置使连接器的电气部件免受影响，比如冲击、异物、湿气、灰尘、水或清洁剂、冷却液、油等其它液体的入侵。

The connector's housing, sealing and locking mechanism protect the connection from external influences such as mechanical shocks, foreign bodies, humidity, dust, water or other fluids such as cleansing and cooling agents, oils, etc.

下面是防护等级一览表 The following table shows the different degrees of protection



数字 Numeral	保护范围 Degree of protection	数字 Numeral	保护范围 Degree of protection
0	无防护 Not evaluated	0	无防护 Not evaluated
1	防止直径大于50mm的固体外物侵入 ≥50.0mm diameter object	1	防止水滴侵入 Dripping water:vertical
2	防止直径大于12.5mm的固体外物侵入 ≥12.5mm diameter object	2	倾斜15度时，仍可防止水滴侵入 Dripping water:15° tilt
3	防止大于直径2.5mm的固体外物侵入 ≥2.5mm diameter object	3	防止喷洒的水侵入 /Spraying water
4	防止大于直径1.0mm的固体外物侵入 ≥1.0mm diameter object	4	防止飞溅的水侵入 Splashing water
5	防止外物及灰尘 Dust-protected	5	防止喷射的水侵入 Jetting water
6	防止外物及灰尘 Dust-tight	6	防止大浪侵入 Powerful jetting water
		7	防止浸水时水的侵入 Temporary immersion
		8	防止沉没时水的侵入 Continuous immersion



电缆接头技术信息 Cable gland information

由于产品描述中含有螺纹尺寸, 采用公制螺纹可方便的理解电缆接头的规格尺寸。  
 请注意采用公制的电缆接头, 最大可夹紧的电缆直径可能变小。  
 The Cross Reference table shows the correlation between the Pg versions and the new metric types.  
 Please notice that the maximum cable diameter will be reduced by the new metric cable glands.

**PG制螺纹与公制螺纹的对照表 Cross Reference :**

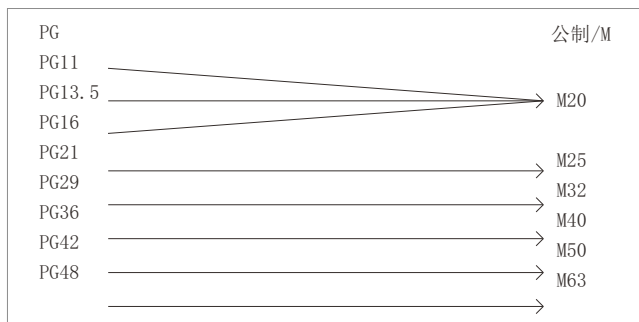

**电缆接头的卡口范围如下 Below is shown the cable range of metric glands :**

1	2	3	4	5	6	7	8	9	10	11	12	13	14	15	16	17	18	19	20	21	22	23	24	25	26	27	28	29	30	31	32	33	34	35	36	37	38	39	40	41	42	43	44	mm																																										
																																							PG48																																															
																																	PG42																																																					
																								PG36																																																														
																		PG29																																																																				
												PG21																																																																										
									PG16																																																																													
							PG13.5																																																																															
						PG11																																																																																
					PG9																																																																																	
				PG7																																																																																		
																																							M63																																															
																																	M50																																																					
																								M40																																																														
																		M32																																																																				
												M25																																																																										
									M20																																																																													
							M20																																																																															
						M18																																																																																
					M16																																																																																	
				M14																																																																																		
			M12																																																																																			

**电缆 Cable**

电缆直径与导线规格及导线数的关系图如右:

The diagram shows different cable-diagrams, being dependent on wire gauges and number of conductors. All data are averages for commercial cables

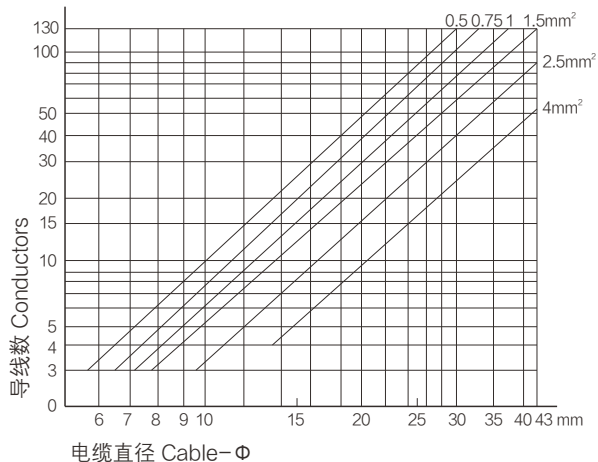



主要部件 Main Components

接插件安装示意图 Assembly details

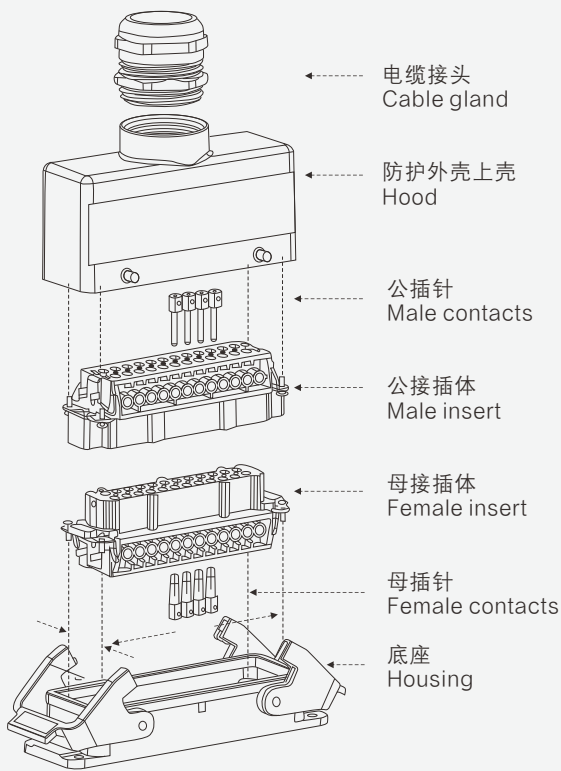

电缆接头 Cable glands

- 金属或塑料电缆接头 Metal or plastic cable glands
- 金属或塑料软管接头 Metal or plastic hose glands
- 其它电缆接头 Other cable glands

防护外壳上壳 Hoods

- 标准或高结构 Low or high construction
- 顶部出线或侧面出线 Top or side cable entry
- 单扣或双扣 1 or 2 locking levers

公、母接插体 Male, female insert

- 螺丝连接 Screw terminal
- 冷压连接 Crimp terminal
- 弹片连接 Cage-clamp terminal

公、母插针 Male, female contacts

- 适用于冷压连接的插体 Only for crimp terminal
- 镀金或镀银 Gold or silver plated

底座 Housing

- 开孔安装, 表面安装或电缆对接 Bulkhead mounting, surface mounting, cable to cable
- 标准或高结构 Low or high construction
- 单扣或双扣 1 or 2 levels
- 带塑料盖或带金属盖或不带盖 Housing with or without covers

订货号说明/Part number explanation

i.e: 09330242601

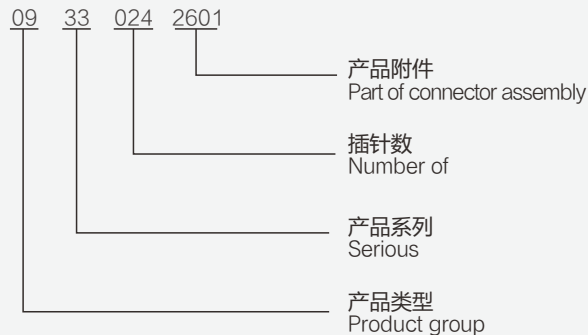



Global District Limited

部分产品一览表 Part of the products

		上壳 Hoods	插体 Inserts								下壳 Housings
				HA Series Screw terminal Crimp terminal	HE Series Screw terminal Crimp terminal	*HEE Series Crimp terminal	*HD Series Crimp terminal	*HDD Series Crimp terminal	HSB Series Screw terminal	HK Series Screw terminal	
3A											
10A											
16A											
32A		用于安装任两个适用于16A外壳插体 Suitable for 2 inserts of size 16A									
6B											
10B											
16B											
24B											
32B		用于安装任两个适用于16B外壳插体 Suitable for 2 inserts of size 16B									
48B		用于安装任两个适用于24B外壳插体 Suitable for 2 inserts of size 24B									

Modified contact loading arrangement permits use up to 500V,690V 1000V at insulation group C.



终端技术 Terminal Technology

冷压连接插体的技术参数 Crimp terminal inserts information

线规 Wire gauge		内部直径 Diameter	剥线长度 Stripping length (mm)		
(mm <sup>2</sup> )	AWG	Φ (mm)	HDD HD R15模块 (10A)	HE HA HvE (16A)	HC (40A)
0.14~0.37	26~22	0.9	8	-	-
0.5	20	1.15	8	7.5	-
0.75	18	1.3	8	7.5	-
1	18	1.45	8	7.5	-
1.5	16	1.75	8	7.5	9
2.5	14	2.25	6	7.5	9
4	12	2.85	-	7.5	9.6
6	10	3.5	-	-	9.6
10	8	4.6	-	-	15

	导体截面 Cross-sec	Φ	剥线长度 Stripping length
100A针	10mm <sup>2</sup>	4.3mm	19.0mm
	16mm <sup>2</sup>	5.5mm	19.0mm
	25mm <sup>2</sup>	7.0mm	19.0mm
	35mm <sup>2</sup>	8.2mm	16.0mm
350A针	35mm <sup>2</sup>	8.2mm	26.0mm
	50mm <sup>2</sup>	10.0mm	28.0mm
	70mm <sup>2</sup>	11.5mm	28.0mm
	95mm <sup>2</sup>	13.5mm	30.0mm
650A针	120mm <sup>2</sup>	15.5mm	24.0mm
	240mm <sup>2</sup>	22.5mm	50.0mm
细股绞线依据Wire assembly according to IEC60228-5			

其他说明 Additional Instruction

建议使用的拧紧力矩和螺丝的尺寸 Recommended tightening torque and size of screw driver

螺丝规格 Screw size	接插件类型 Connector type	拧紧力矩 Tightening torque (N.m)	拧紧力矩 Tightening torque (lbf)	建议使用螺丝刀的尺寸 Recommended size of screw driver
M3	螺丝端子 Screw terminal HA-003/HA-004	.25	0.2	0.4x2.5
M3	螺丝端子 Screw terminal HA-010/HA-016	0.5	0.4	0.5x3.5 or +Size1
M3	螺丝端子HE, 定位及固定用 Screw terminal HE, Guiding pins and bushes	0.50	0.40	"0.5 x 3.5"
M4	接地螺钉端子 Ground terminal HA, HE, HD, HDD	1.2	0.9	0.5x3.5 or +Size1+2
M4	端子块 Screw terminal HSB	1.2	0.9	0.80 x 4.5
M5	接地螺钉端子 Ground terminal HSB	2.00	1.40	"0.8 x 4.5 or 1.2 x 8"



## 接线端子类型 Terminal Type

## 螺钉压接形式 Screw terminal

HA系列 Haseries  
HE/HVE 系列 HE/HVE series  
HSB系列 HSB series  
HK系列 HK series  
HWK系列 HWK series  
HEAV系列 HEAV series

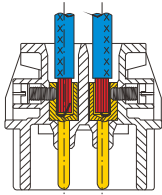

操作简单  
Easy handling

无需专用工具  
No special tools

接插芯 Inserts	最大线规 Max.wire gauge		剥线长度L(mm) Stripping length L(mm)
	mm <sup>2</sup>	AWG	
HA-003,HA-004	2.5	14	4.5
HE,HA,HEAV	2.5	14	7.5
HE,HVE	4.0	12	7.5
HSB	6.0	10	11.5
HK,HWK	16.0	5.0	14

## 冷压针压接形式 Crimp terminal

HD 系列 HD series  
HDD 系列 HDD series

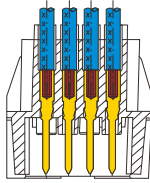

由于压接质量均匀，所以  
通向电阻恒定  
Constant contact resistance  
as a result of precisely repeated  
crimp connection quality

由于接近于冷焊，所以保证了  
耐腐蚀性  
Corrosion free connections  
as a result of cold weld action

接插芯 Inserts	最大线规 Max.wire gauge		剥线长度L(mm) Stripping length L(mm)	
	mm <sup>2</sup>	AWG	HDD/HD	HEC/HAC
HD	0.5	20	8.0	7.5
	0.75	18	8.0	7.5
HDD	1.0	18	8.0	7.5
	1.5	16	8.0	7.5
HM(10A)	2.5	14	8.0	7.5
	4.0	12	8.0	7.5

HE/HEE 系列 Series  
HEEE 系列 Series  
HM 系列 series

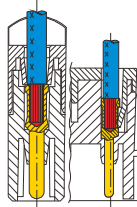

预制了带压接针的电缆束  
Pre-preparation of cable  
forms with crimp  
contacts fitted

从根本上提高了布线速度  
Optimum cost cable  
connection

接插芯 Inserts	最大线规 Max.wire gauge		剥线长度L(mm) Stripping length L(mm)	
	mm <sup>2</sup>	AWG	HEE/HM(40A)	
HE	0.5	20	7.5	
	0.75	18	7.5	
HEE	1.0	18	7.5	
	1.5	16	7.5	
HEEE	2.5	14	7.5	
	4.0	12	7.5	

## 弹片压接端子形式 Cage-clamp terminal

HE系列 Series

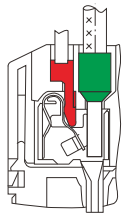

这种连接技术对操作和工具的要求较小，  
且具有较高的功能安全性。

This termination method requires very  
little preparation of the wire and on  
special tools, leading to a low installed  
cost and a high degree of mechanical  
security.

由于操作人员可以看到导线和螺丝刀，因此  
具有较高的操作舒适度。  
Ease of termination. Conductor and  
screwdriver are in same plane.

接插芯 Inserts	最大线规 Max.wire gauge		剥线长度L(mm) Stripping length L(mm)
	mm <sup>2</sup>	AWG	
HE	0.14-2.5	26-14	9-11

无需对导线头进行特殊处理。  
No special preparation of  
stripped conductor.

安装状态下可从接线侧进行检测。  
From the terminal side for testing  
installation condition.

夹紧力随导线截面的增加而提高。  
The larger the conductor the  
higher the clamping force.

导线连接防振动和冲击。  
The termination is vibration-proof.

## 轴向螺栓压接形式 Axial screw terminal

HK-006/6  
HK-006/12  
HK-008/0

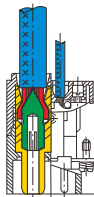

节省空间  
Less space required

操作简单  
Easy handling

无需专用工具  
No special tools

接插芯 Inserts	最大线规 Max.wire gauge		剥线长度L(mm) Stripping length L(mm)
	mm <sup>2</sup>	AWG	
HK-006/6	16-35	5-2	13-14
HK-006/12	2.5-10	13/-1	8-9
HK-008/0	10-25	16/-1	6-7

## 建议使用的拧紧力矩和螺丝刀的尺寸 Recommended screw drivers and tightening torques

螺钉尺寸 Size of screw	接插件类型 Connector type	拧紧力矩 (Φ) Tightening torque [Nm]	拧紧力矩 (Φ) Tightening torque [Nm]	建议使用螺丝刀尺寸 Recommended size of screw driver
M3	螺钉端子 Screw terminal HA-003/HA-004/HQ-005	0.25	0.20	0.4×2.5
M3	螺钉端子 Screw terminal HA-010/HA-016	0.50	0.40	0.5×3.5 or ± size 1
M3	螺钉端子 HE, HEAV 定位及固定用 Screw terminal HE, HEAV fixing screws of all kinds, guiding pins and bushes	0.50	0.40	0.5×3.5
M4	接地端子螺钉 Ground terminal HA, HE, HD, HDD	1.20	0.90	0.5×3.5 or ± size 1+2
M4	端子块 Terminal blocks HSB	1.20	0.90	0.8×4.5
M5	接地端子螺钉 Ground terminal HSB	2.00	1.40	0.8×4.5 or 1.2×8.0





选型指南 Selection Guide

购买重型连接器时，我们可以做如下选择 When selecting heavy duty connector,we need to choose as following

NO.1

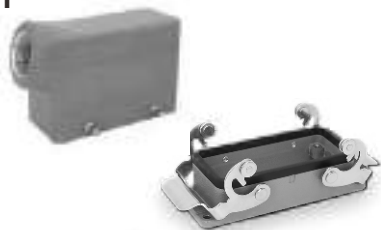

上壳侧出，底座开孔形式  
Hood side-entry type,Housing bulkhead mounting

NO.2



上壳顶出，底座开孔形式  
Hood top-entry type,Housing bulkhead mounting

NO.3



上壳侧出，底座表面形式  
Hood side-entry type,Housing surface mounting

NO.4



上壳顶出，底座表面形式  
Hood top-entry type,Housing surface mounting

NO.5



上壳侧出，底座开孔带盖形式  
Hood side-entry type,Housing bulkhead mounting cover

NO.6



上壳顶出，底座开孔带盖形式  
Hood top-entry type,Housing bulkhead mounting cover

NO.7



上壳侧出，底座表面带盖形式  
Hood side-entry type,Housing surface mounting cover

NO.8



上壳顶出，底座表面带盖形式  
Hood top-entry type,Housing surface mounting cover

NO.9



上壳顶出，下壳对接形式  
Hood top-entry type,Housing cable to cable coupling

订购完整连接器套件步骤：

For a complete connector components may be order from the following sub headings:

1 接插体类别 Connector type

如：24芯螺钉压接接插体型号为 HE-024  
i.e.:24-polescrew terminal part NO.HE-024

2 壳体组合类别 List hoods and housings

常见九种组合方式见上图如：1是上壳侧出底座开孔形式  
i.e.: “1” Hood side-entry type,Housing bulkhead mounting

3 螺丝毫米大小 Threaded hole size

如：“M25”代表出线口螺纹为公制M25  
i.e.: “M25” metric thread M25

例如：HK-HE-024.1-M25 代表接插体是HE-024，外壳是第一种组合（开孔侧出），上壳出线口螺纹为M25。

套件订货说明 Ordering system computerized

为了便于数据处理，订货时也可采用如下订货方式：

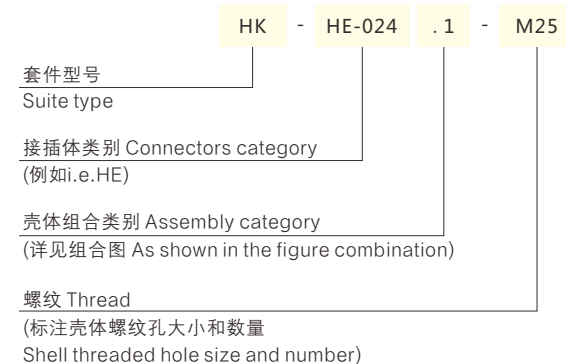



## 直插式重载连接器产品介绍 Quick Lock Terminal

### 产品研发背景 Product development background

随着人工成本的持续升高，产品成本随之增加，导致工业设备厂家失去产品竞争力；而大部分工时的消耗发生在基础工艺工序；因此，有必要对基础元件的产品进行结构优化，提高工作效率，吴科直插式连接器颠覆传统接线工艺，在满足传统螺钉压接、笼式压接连接器，所有功能以外，在使用效率上有大幅提高。



产品推荐

### 功能描述 Function description

1 在开孔安装の場合，直插式连接器可实现连接器预安装在柜体上，再接线，如图一



图 1



2 为不影响柜内接线的整洁及规范、柜内的线束长度一般会尽量缩短，螺钉安装的连接由于压螺丝被壳体遮挡，需要把线预留的长一些拉到柜体外，先接到连接器上再固定外壳，这时柜内的线就会过长，影响布线工艺 如图二



图 2



3 直插式接线方式可轻松的接线，当产品需增减某些线束时，直插式连接器也不需要拆装连接器壳体就可实现，如图三

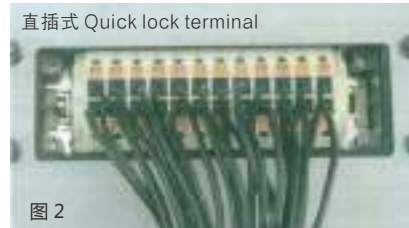

图 3

4 直插式连接器为用户预留的测试孔，可实现带电测试，如图四



图 4

5 直插式连接器运用编码块（图五）替代传统的编码销，实现多个连接器防插错，工艺简单、成本极低、将编码块压入插槽内即可实现（图六）

图 5



传统连接器运用编码销，需要先把固定螺丝取下，换上编码销，操作麻烦费时间，且价格相比编码块高昂。

图 6

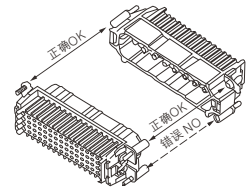

### 产品接线方式对比 Product wiring method

产品 Product	直插式 Quick lock terminal 24 inserts(公插M+母插F)	弹片压接 Cage-clamp terminal 24 inserts(公插M+母插F)	螺钉压接 Screw terminal 24 inserts(公插M+母插F)
接线耗时 Connection time	6分钟min	12.5分钟min	15分钟min

### 1 直插式弹片接线方式 Quick Lock terminal



Step 1: 导线插入 Wire insertion



Step 2: 接线完成 Connection completion

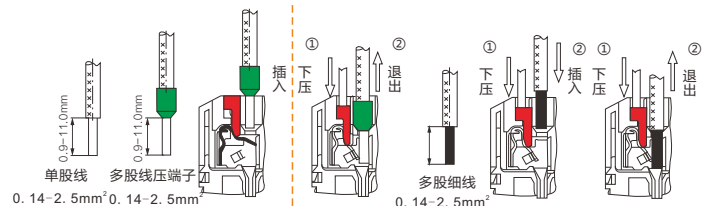

### 2 普通弹片接线方式 Cage-clamp terminal



Step 1: 螺钉起子插入正方形插孔中，弹片被推向一侧，从而打开接线口。



Step 2: 将线缆插入圆形接线口。



Step 3: 取出螺丝起子，弹片收回原位，从而夹紧插入的线缆。



Step 4: 连接完成，请拉动线缆以确认线缆确实被弹片夹紧。

### 3 螺钉接线方式 Screw terminal

手工拧紧或电动螺丝刀拧紧，拧紧力不一致，导致螺丝没拧到位，同时在振动条件，螺丝有松脱可能。因为拧紧力度不一样，使用工具的不规范，容易导致十字螺丝头打滑，从而极大的增加了作业人员的劳动强度。

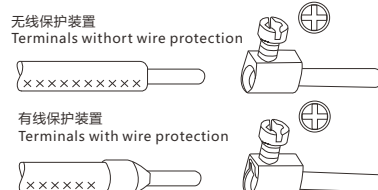



## HA 系列 / HA SERIES

### 技术参数 Technical Characteristics

规范	Specifications	
规范	Specifications	DIN EN 60 664
		DIN EN 61 984
插芯	Inserts	
接插件针数	Number Of Contacts	3,4,10,16,32(2X16)+PE
HA-003/004		
额定电流	Rated Current	10A
相对地额定电压	Rated Voltage Conductor-ground	230V
相间额定电压	Rated Voltage Conductor-conductor	400V
额定脉冲电压	Rated Impulse Voltage	4kV
污染程度	Pollution Degree	3
或	Or	10A 250V 4kV 3
HA-010/016		
额定电流	Rated Current	16A
额定电压	Rated Voltage	250V
额定脉冲电压	Rated Impulse Voltage	4kV
污染程度	Pollution Degree	3
污染等级2时的参数	Pollution Degree 2 Also	16A 230/400V 4kV 2
依据UL/CSA额定电压	Rated Voltage Acc.to UI Csa	600V
绝缘电阻	Insulation Resistance	$\geq 10^{10} \Omega$
材料	Material	聚碳酸酯 Polycarbonate
工作温度范围	Limiting Temperatures	-40°C...+125°C
阻燃等级	Flammability Acc. To UI94	V0
可拔插次数	Mechanical Working Life-mating Cycles	$\geq 500$
插针	Contacts	
材料	Material	铜合金 Copper Alloy
表面处理	Surface	镀金 Hard-gold Plated 镀银 Hard-silver Plated
接触电阻	Contact Resistance	$\leq 1m\Omega$
螺钉连接	Screw Terminal	
导线规格	Wire Gauge	1.0-2.5mm <sup>2</sup>
AWG	Awg	18-14
拧紧力矩	Tightening Torque	0.25Nm ( HA-003/004 ) or 0.5Nm ( HA-010/016 )
冷压连接	Crimp Terminal	
-导线规格	Wire Gauge	0.14-4.0mm <sup>2</sup>
-AWG	Awg	26-12
弹片连接	Cage-clamp	
导线规格	Wire Gauge	0.14-2.5mm <sup>2</sup>
AWG	Awg	26-14

#### 电流负载能力 Current Carrying Capacity

电流负载能力所受的限制主要来自包含接插针的接插体可承受的最大温度

The current carrying is limited by maximum temperature of materials for Inserts and contacts including terminals.

测试和控制过程依据 Measuring and testing techniques according to DIN EN 60512-5

①线径 Wire gauge: 2.5mm<sup>2</sup> ②线径 Wire gauge: 1.5mm<sup>2</sup> ③线径 Wire gauge: 1.0mm<sup>2</sup>

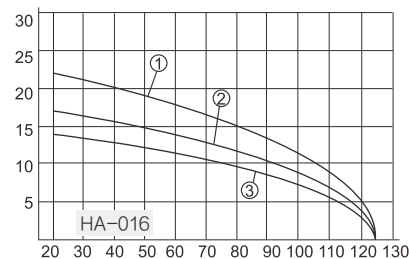
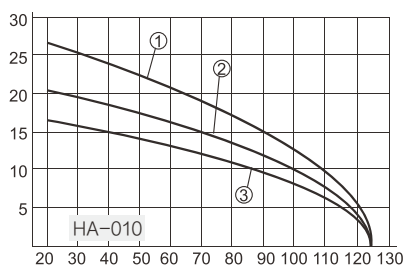
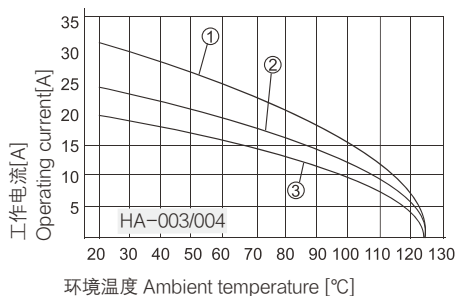



插芯 Inserts

外壳尺寸：匹配3A外壳，详情请参考11-05~11-11页

Hoods/Housings：Matching 3A Hood Housing，detail on P11-05~P11-11

螺丝连接 Screw terminal



插芯 Inserts	型号 Type	订货号 Part Number
公 Male	HA-003-M	09200032611
母 Female	HA-003-F	09200032711

公 Male	HA-004-M	09200042611
母 Female	HA-004-F	09200042711

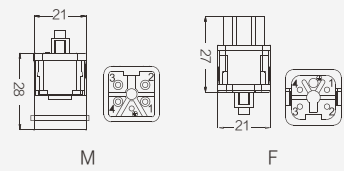
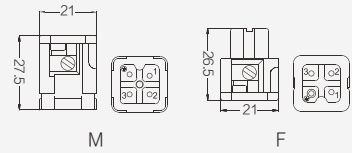

弹片连接 Cage-clamp



插芯 Inserts	型号 Type	订货号 Part Number
公 Male	HA-003-MS	09200032633
母 Female	HA-003-FS	09200032733

公 Male	HA-004-MS	09200042633
母 Female	HA-004-FS	09200042733

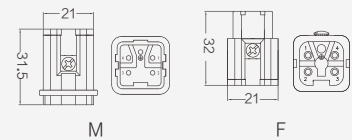
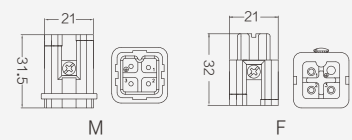



Global District Limited

HA-010 小型插芯 The Slim Inserts 230/400V 16A 10+⊕

插芯 Inserts

外壳尺寸：匹配10A外壳，详情请参考12-01~12-02页

Hoods/Housings：Matching 10A Hood Housing，detail on P12-01~P12-02

螺丝连接 Screw terminal



插芯 Inserts	型号 Type	订货号 Part Number
公 Male	HA-010-M	09200102612
母 Female	HA-010-F	09200102812

冷压连接 Crimp terminal



插芯 Inserts	型号 Type	订货号 Part Number
公 Male	HA-010-MC	09200103001
母 Female	HA-010-FC	09200103101

1) 接插体之间的最大距离24mm  
1) Distance for contact max.24mm

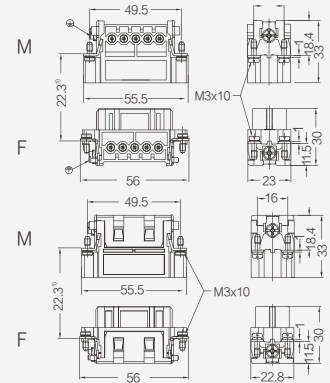

接插针排序

Contacts arrangement view from termination side



面板安装开孔图

Panel cut out for Inserts for use without Hoods/housings

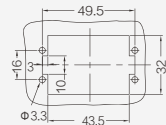

附件 Accessories

16A 冷压针 Crimp contacts

接触电阻 Contact resistance  $\leq 1m\Omega$   
镀银 Silver plated



公 Male	订货号 Part Number	母 Female	订货号 Part Number
CESM-0.37	09330006127	CESF-0.37	09330006227
CESM-0.5	09330006121	CESF-0.5	09330006220
CESM-0.75	09330006114	CESF-0.75	09330006214
CESM-1.0	09330006105	CESF-1.0	09330006205
CESM-1.5	09330006104	CESF-1.5	09330006204
CESM-2.5	09330006102	CESF-2.5	09330006202
CESM-3.0	09330006106	CESF-3.0	09330006206
CESM-4.0	09330006107	CESF-4.0	09330006207

镀金 Gold plated



公 Male	订货号 Part Number	母 Female	订货号 Part Number
CEGM-0.37	09330006117	CEGF-0.37	09330006217
CEGM-0.5	09330006122	CEGF-0.5	09330006222
CEGM-0.75	09330006115	CEGF-0.75	09330006215
CEGM-1.0	09330006118	CEGF-1.0	09330006218
CEGM-1.5	09330006116	CEGF-1.5	09330006216
CEGM-2.5	09330006123	CEGF-2.5	09330006223
CEGM-4.0	09330006119	CEGF-4.0	09330006221

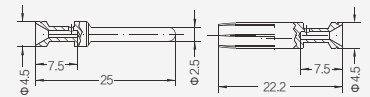

标示 Identification	线规 Wire gauge	剥线长度 Stripping length	
no groove	0.14-0.37mm <sup>2</sup>	AWG 26-22	7.5mm
no groove	0.5mm <sup>2</sup>	AWG 20	7.5mm
1 groove	0.75mm <sup>2</sup>	AWG 18	7.5mm
1 groove	1.0mm <sup>2</sup>	AWG 18	7.5mm
2 groove	1.5mm <sup>2</sup>	AWG 16	7.5mm
3 groove	2.5mm <sup>2</sup>	AWG 14	7.5mm
wide groove	3mm <sup>2</sup>	AWG 12	7.5mm
no groove	4mm <sup>2</sup>	AWG 12	7.5mm

工具 Tools

冷压钳 Crimping tool



压接线经 Wire gauge	型号 Type	订货号 Part Number
0.5-4mm <sup>2</sup>	TL02G	09990000021

退针器 Removal tool



适用类型 For	型号 Type	订货号 Part Number
16A 冷压针	TL01	09990000059
16A Crimp contacts		

更多工具请参考 25-01~25-02页 More tools on P25-01~P25-02



HA-016 小型插芯 The Slim Inserts 250V 16A 16+⊕

插芯 Inserts

外壳尺寸：匹配16A外壳，详情请参考13-01~13-02页

Hoods/Housings：Matching 16A Hood Housing，detail on P13-01~P13-02

螺丝连接 Screw terminal



插芯 Inserts	型号 Type	订货号 Part Number
公 Male	HA-016-M	09200162612
母 Female	HA-016-F	09200162812

冷压连接 Crimp terminal



插芯 Inserts	型号 Type	订货号 Part Number
公 Male	HA-016-MC	09200163001
母 Female	HA-016-FC	09200163101

1) 接插体之间的最大距离24mm

1) Distance for contact max.24mm

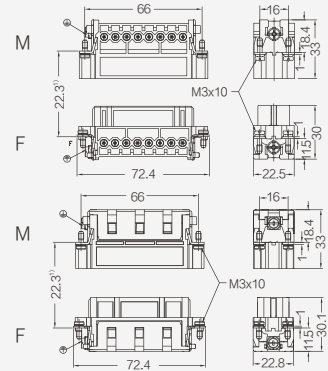

接插针排序

Contacts arrangement view from termination side

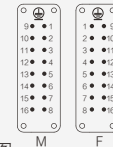

面板安装开孔图

Panel cut out for Inserts for use without Hoods/housings

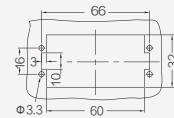

附件 Accessories

16A 冷压针 Crimp contacts

接触电阻 Contact resistance  $\leq 1m\Omega$   
镀银 Silver plated



公 Male	订货号 Part Number	母 Female	订货号 Part Number
CESM-0.37	09330006127	CESF-0.37	09330006227
CESM-0.5	09330006121	CESF-0.5	09330006220
CESM-0.75	09330006114	CESF-0.75	09330006214
CESM-1.0	09330006105	CESF-1.0	09330006205
CESM-1.5	09330006104	CESF-1.5	09330006204
CESM-2.5	09330006102	CESF-2.5	09330006202
CESM-3.0	09330006106	CESF-3.0	09330006206
CESM-4.0	09330006107	CESF-4.0	09330006207

镀金 Gold plated



公 Male	订货号 Part Number	母 Female	订货号 Part Number
CEGM-0.37	09330006117	CEGF-0.37	09330006217
CEGM-0.5	09330006122	CEGF-0.5	09330006222
CEGM-0.75	09330006115	CEGF-0.75	09330006215
CEGM-1.0	09330006118	CEGF-1.0	09330006218
CEGM-1.5	09330006116	CEGF-1.5	09330006216
CEGM-2.5	09330006123	CEGF-2.5	09330006223
CEGM-4.0	09330006119	CEGF-4.0	09330006221

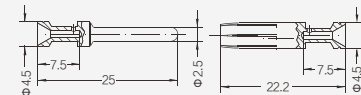

标示 Identification	线规 Wire gauge	剥线长度 Stripping length	
no groove	0.14-0.37mm <sup>2</sup>	AWG 26-22	7.5mm
no groove	0.5mm <sup>2</sup>	AWG 20	7.5mm
1 groove	0.75mm <sup>2</sup>	AWG 18	7.5mm
1 groove	1.0mm <sup>2</sup>	AWG 18	7.5mm
2 groove	1.5mm <sup>2</sup>	AWG 16	7.5mm
3 groove	2.5mm <sup>2</sup>	AWG 14	7.5mm
wide groove	3mm <sup>2</sup>	AWG 12	7.5mm
no groove	4mm <sup>2</sup>	AWG 12	7.5mm

工具 Tools

冷压钳 Crimping tool



压接线经 Wire gauge	型号 Type	订货号 Part Number
0.5-4mm <sup>2</sup>	TL02G	09990000021

退针器 Removal tool



适用类型 For	型号 Type	订货号 Part Number
16A 冷压针 16A Crimp contacts	TL01	09990000059

更多工具请参考 25-01~25-02页 More tools on P25-01~P25-02



**Global District Limited**

HA-032 小型插芯 The Slim Inserts 250V 16A 32+

**插芯 Inserts**

外壳尺寸：匹配32A外壳，详情请参考14-01~14-02页

Hoods/Housings：Matching 32A Hood Housing，detail on P14-01~P14-02

螺丝连接 Screw terminal



插芯 Inserts	型号 Type	订货号 Part Number
公 Male	HA-016-M(1-16)	09200162612
	HA-016-M(17-32)	09200162613
母 Female	HA-016-F(1-16)	09200162812
	HA-016-F(17-32)	09200162813

冷压连接 Crimp terminal



插芯 Inserts	型号 Type	订货号 Part Number
公 Male	HA-016-MC(1-16)	09200163001
	HA-016-MC(17-32)	09200163011
母 Female	HA-016-FC(1-16)	09200163101
	HA-016-FC(17-32)	09200163111

1) 接插体之间的最大距离24mm

1) Distance for contact max.24mm

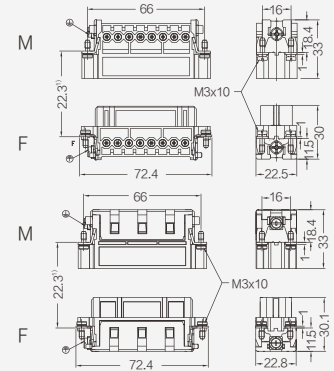

接插针排序

Contacts arrangement view from termination side

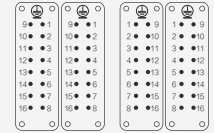

面板安装开孔图

Panel cut out for inserts for use without Hoods/housings

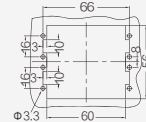

**附件 Accessories**

16A 冷压针 Crimp contacts

接触电阻 Contact resistance  $\leq 1m\Omega$   
镀银 Silver plated



公 Male	订货号 Part Number	母 Female	订货号 Part Number
CESM-0.37	09330006127	CESF-0.37	09330006227
CESM-0.5	09330006121	CESF-0.5	09330006220
CESM-0.75	09330006114	CESF-0.75	09330006214
CESM-1.0	09330006105	CESF-1.0	09330006205
CESM-1.5	09330006104	CESF-1.5	09330006204
CESM-2.5	09330006102	CESF-2.5	09330006202
CESM-3.0	09330006106	CESF-3.0	09330006206
CESM-4.0	09330006107	CESF-4.0	09330006207

镀金 Gold plated



公 Male	订货号 Part Number	母 Female	订货号 Part Number
CEGM-0.37	09330006117	CEGF-0.37	09330006217
CEGM-0.5	09330006122	CEGF-0.5	09330006222
CEGM-0.75	09330006115	CEGF-0.75	09330006215
CEGM-1.0	09330006118	CEGF-1.0	09330006218
CEGM-1.5	09330006116	CEGF-1.5	09330006216
CEGM-2.5	09330006123	CEGF-2.5	09330006223
CEGM-4.0	09330006119	CEGF-4.0	09330006221

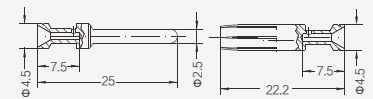

标示 Identification	线规 Wire gauge	剥线长度 Stripping length
no groove	014-0.37mm <sup>2</sup>	AWG 26-22
no groove	0.5mm <sup>2</sup>	AWG 20
1 groove	0.75mm <sup>2</sup>	AWG 18
1 groove	1.1mm <sup>2</sup>	AWG 18
2 groove	1.5mm <sup>2</sup>	AWG 16
3 groove	2.5mm <sup>2</sup>	AWG 14
wide groove	3mm <sup>2</sup>	AWG 12
no groove	4mm <sup>2</sup>	AWG 12

工具 Tools

冷压钳 Crimping tool



压接线经 Wire gauge	型号 Type	订货号 Part Number
0.5-4mm <sup>2</sup>	TL02G	09990000021

退针器 Removal tool



适用类型 For	型号 Type	订货号 Part Number
16A 冷压针	TL01	09990000059
16A Crimp contacts		

更多工具请参考 25-01~25-02页 More tools on P25-01~P25-02



HE 系列 / HE SERIES

技术参数 Technical Characteristics

规范	Specifications	
规范	Specifications	DIN EN 60 664
		DIN EN 61 984
插芯	Inserts	
依据 EN 61 984的额定电压	Electrical data acc. to EN 61 984	
接插件针数	Number Of Contacts	6,10,16,24,32(2X16),48(2X24)+PE
-额定电流	Rated Current	16A
-额定电压	Rated Voltage	500V
-额定脉冲电压	Rated Impulse Voltage	6kV
-污染程度	Pollution Degree	3
-污染等级2时的参数	Pollution Degree 2 Also	16A 400/690V 6kV 2
依据UL/CSA额定电压	Rated Voltage Acc. To UI CSA	600V
绝缘电阻	Insulation Resistance	≥ 1010 Ω
材料	Material	聚碳酸酯 Polycarbonate
工作温度范围	Limiting Temperatures	-40°C...+125°C
依据UL94阻燃等级	Flammability Acc. To UL94	V0
可拔插次数	Mechanical Working Life-mating Cycles	≥ 500
插针	Contacts	
材料	Material	铜合金 Copper Alloy
表面处理	Surface	镀金 Hard-gold Plated 镀银 Hard-silver Plated
接触电阻	Contact Resistance	≤ 1mΩ
螺钉连接	Screw Terminal	
-导线规格	-Wire Gauge	0.14-2.5mm <sup>2</sup>
-AWG	-AWG	26-14
-拧紧力矩	-Tightening Torque	0.5Nm
-剥线长度	-Stripping length	7.0mm
冷压连接	Crimp Terminal	
-导线规格	Wire Gauge	0.14-4.0mm <sup>2</sup>
-AWG	-AWG	26-12
-剥线长度	-Stripping length	7.5mm
弹片连接	Cage-clamp	
-导线规格	Wire Gauge	0.14-2.5mm <sup>2</sup>
-AWG	-AWG	26-14
-剥线长度	-Stripping length	7-9mm

电流负载能力 Current Carrying Capacity

电流负载能力所受的限制主要来自包含接插针的接插体可承受的最大温度

The current carrying is limited by maximum temperature of materials for inserts and contacts including terminals.

测试和控制过程依据 Measuring and testing techniques according to DIN EN 60512-5

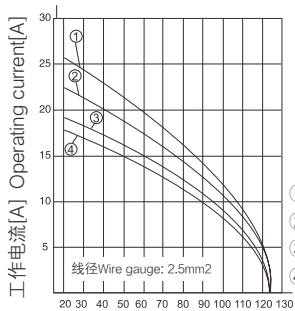

① HE-006-M/F(MC/FC)  
② HE-010-M/F(MC/FC)  
③ HE-016-M/F(MC/FC)  
④ HE-024-M/F(MC/FC)

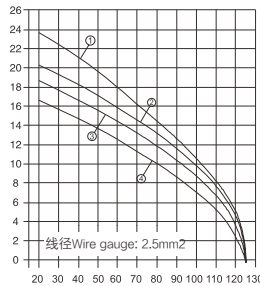

① HE-006-MS/FS  
② HE-010-MS/FS  
③ HE-016-MS/FS  
④ HE-024-MS/FS

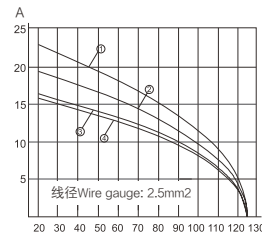

① HE-006-MSS/FSS  
② HE-010-MSS/FSS  
③ HE-016-MSS/FSS  
④ HE-024-MSS/FSS

环境温度 Ambient temperature [°C]





HE-006 常规型插芯 Standard Inserts 500V 16A 6+  $\oplus$

插芯 Inserts

外壳尺寸：匹配6B外壳，详情请参考15-01~15-10页

Hoods/Housings：Matching 6B Hood Housing，detail on P15-01~P15-10

螺丝连接 Screw terminal



插芯 Inserts	型号 Type	订货号 Part Number
公 Male	HE-006-M	09330062601
母 Female	HE-006-F	09330062701

冷压连接 Crimp terminal



插芯 Inserts	型号 Type	订货号 Part Number
公 Male	HE-006-MC	09330062602
母 Female	HE-006-FC	09330062702

弹片连接 Cage-clamp



插芯 Inserts	型号 Type	订货号 Part Number
公 Male	HE-006-MS	09330062616
母 Female	HE-006-FS	09330062716

NEW

直插式弹片连接 Quick lock terminal



公 Male	HE-006-MZ	09330062801
母 Female	HE-006-FZ	09330062901

关于直插式弹片连接的优势，详见P00-14



双弹片连接(一针双接线) Cage-clamp terminal (two terminal per contact)

公 Male	HE-006-MSS	09330062672
母 Female	HE-006-FSS	09330062772

1) 接插体之间的最大距离21mm

1) Distance for contact max.21mm

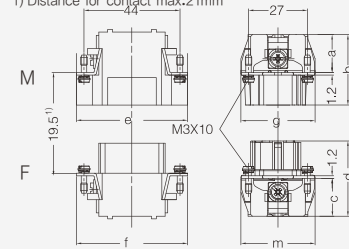

	a	b	e	g	c	d	f	m
MF	16	32.4	51	34	16.8	34.8	51	34
MCFC	18	33.5	51	34	18	35	51	34
MSFS	18	33.5	51	34	18.2	35.4	51	34
MSS/FSS	34.5	49.5	50	34	33.4	50	50	34
MZ/FZ	17.4	34.5	51	33.8	17.2	36.7	51	34

接插针排序

Contacts arrangement view from termination side

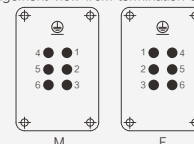

面板安装开孔图

Panel cut out for inserts for use without Hoods/housings

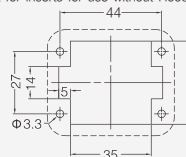

附件 Accessories

16A 冷压针 Crimp contacts

接触电阻 Contact resistance  $\leq 1m\Omega$   
镀银 Silver plated



公 Male	订货号 Part Number	母 Female	订货号 Part Number
CESM-0.37	09330006127	CESF-0.37	09330006227
CESM-0.5	09330006121	CESF-0.5	09330006220
CESM-0.75	09330006114	CESF-0.75	09330006214
CESM-1.0	09330006105	CESF-1.0	09330006205
CESM-1.5	09330006104	CESF-1.5	09330006204
CESM-2.5	09330006102	CESF-2.5	09330006202
CESM-3.0	09330006106	CESF-3.0	09330006206
CESM-4.0	09330006107	CESF-4.0	09330006207

镀金 Gold plated



CEGM-0.37	09330006117	CEGF-0.37	09330006217
CEGM-0.5	09330006122	CEGF-0.5	09330006222
CEGM-0.75	09330006115	CEGF-0.75	09330006215
CEGM-1.0	09330006118	CEGF-1.0	09330006218
CEGM-1.5	09330006116	CEGF-1.5	09330006216
CEGM-2.5	09330006123	CEGF-2.5	09330006223
CEGM-4.0	09330006119	CEGF-4.0	09330006221

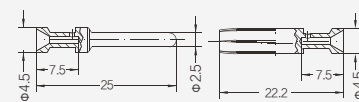

M F

标示 Identification	线规 Wire gauge	剥线长度 Stripping length
no groove	0.14-0.37mm <sup>2</sup> AWG 26-22	7.5mm
1 groove	0.5mm <sup>2</sup> AWG 20	7.5mm
1 groove	0.75mm <sup>2</sup> AWG 18	7.5mm
2 groove	1.5mm <sup>2</sup> AWG 16	7.5mm
3 groove	2.5mm <sup>2</sup> AWG 14	7.5mm
wide groove	3mm <sup>2</sup> AWG 12	7.5mm
no groove	4mm <sup>2</sup> AWG 12	7.5mm

工具 Tools

冷压钳 Crimping tool



压接线经 Wire gauge	型号 Type	订货号 Part Number
0.5-4mm <sup>2</sup>	TL02G	09990000021

退针器 Removal tool



适用类型 For	型号 Type	订货号 Part Number
16A 冷压针 16A Crimp contacts	TL01	09990000059

更多工具请参考 25-01~25-02页 More tools on P25-01~P25-02



Global District Limited

HE-010 常规型插芯 Standard Inserts 500V 16A 10+

## 插芯 Inserts

外壳尺寸：匹配10B外壳，详情请参考16-01~16-13页

Hoods/Housings：Matching 10B Hood Housing，detail on P16-01~P16-13

## 螺丝连接 Screw terminal



插芯 Inserts	型号 Type	订货号 Part Number
公 Male	HE-010-M	09330102601
母 Female	HE-010-F	09330102701

## 冷压连接 Crimp terminal



插芯 Inserts	型号 Type	订货号 Part Number
公 Male	HE-010-MC	09330102602
母 Female	HE-010-FC	09330102702

## 弹片连接 Cage-clamp



插芯 Inserts	型号 Type	订货号 Part Number
公 Male	HE-010-MS	09330102616
母 Female	HE-010-FS	09330102716

NEW



## 直插式弹片连接 Quick lock terminal

公 Male	HE-010-MZ	09330102801
母 Female	HE-010-FZ	09330102901

关于直插式弹片连接的优势，详见P00-14



## 双弹片连接(一针双接线) Cage-clamp terminal (two terminal per contact)

公 Male	HE-010-MSS	09330102672
母 Female	HE-010-FSS	09330102772

## 1) 接插体之间的最大距离21mm

1) Distance for contact max.21mm

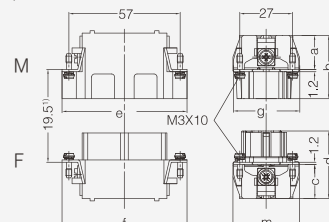

	a	b	e	g	c	d	f	m
M/F	16.5	32.5	64.5	34	16.8	34.8	64.5	34
MC/FC	18	33.5	64	34	17.5	35.2	64.5	34
MS/FSS	18.5	33.5	64	34	16.5	35.6	64.5	34
MSS/FSS	34	49	64	34	33.5	49.5	63	34
MZ/FZ	17.4	34.5	64	33.8	17.2	36.8	64.5	34

## 接插针排序

Contacts arrangement view from termination side

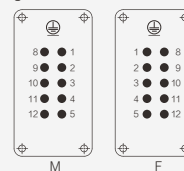

## 面板安装开孔图

Panel cut out for inserts for use without Hoods/housings

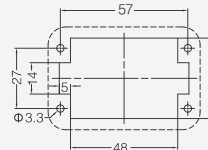

## 附件 Accessories

## 16A 冷压针 Crimp contacts

接触电阻 Contact resistance  $\leq 1\text{m}\Omega$   
镀银 Silver plated

公 Male	订货号 Part Number	母 Female	订货号 Part Number
CESM-0.37	09330006127	CESF-0.37	09330006227
CESM-0.5	09330006121	CESF-0.5	09330006220
CESM-0.75	09330006114	CESF-0.75	09330006214
CESM-1.0	09330006105	CESF-1.0	09330006205
CESM-1.5	09330006104	CESF-1.5	09330006204
CESM-2.5	09330006102	CESF-2.5	09330006202
CESM-3.0	09330006106	CESF-3.0	09330006206
CESM-4.0	09330006107	CESF-4.0	09330006207

镀金 Gold plated



CEGM-0.37	09330006117	CEGF-0.37	09330006217
CEGM-0.5	09330006122	CEGF-0.5	09330006222
CEGM-0.75	09330006115	CEGF-0.75	09330006215
CEGM-1.0	09330006118	CEGF-1.0	09330006218
CEGM-1.5	09330006116	CEGF-1.5	09330006216
CEGM-2.5	09330006123	CEGF-2.5	09330006223
CEGM-4.0	09330006119	CEGF-4.0	09330006221

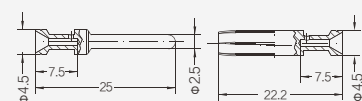

标示 Identification	线规 Wire gauge	剥线长度 Stripping length	
no groove	014-0.37mm <sup>2</sup>	AWG 26-22	7.5mm
no groove	0.5mm <sup>2</sup>	AWG 20	7.5mm
1 groove	0.75mm <sup>2</sup>	AWG 18	7.5mm
1 groove	1.1mm <sup>2</sup>	AWG 18	7.5mm
2 groove	1.5mm <sup>2</sup>	AWG 16	7.5mm
3 groove	2.5mm <sup>2</sup>	AWG 14	7.5mm
wide groove	3mm <sup>2</sup>	AWG 12	7.5mm
no groove	4mm <sup>2</sup>	AWG 12	7.5mm

## 工具 Tools

## 冷压钳 Crimping tool



压接线经 Wire gauge	型号 Type	订货号 Part Number
0.5-4mm <sup>2</sup>	TL02G	09990000021

## 退针器 Removal tool



适用类型 For	型号 Type	订货号 Part Number
16A 冷压针 16A Crimp contacts	TL01	09990000059

更多工具请参考 25-01~25-02页 More tools on P25-01~P25-02



HE-016 常规型插芯 Standard Inserts 500V 16A 16+

插芯 Inserts

外壳尺寸：匹配16B外壳，详情请参考17-01~17-21页

Hoods/Housings：Matching 16B Hood Housing，detail on P17-01~P17-21页

螺丝连接 Screw terminal



插芯 Inserts	型号 Type	订货号 Part Number
公 Male	HE-016-M	09330162601
母 Female	HE-016-F	09330162701

冷压连接 Crimp terminal



插芯 Inserts	型号 Type	订货号 Part Number
公 Male	HE-016-MC	09330162602
母 Female	HE-016-FC	09330162702

弹片连接 Cage-clamp



插芯 Inserts	型号 Type	订货号 Part Number
公 Male	HE-016-MS	09330162616
母 Female	HE-016-FS	09330162716



直插式弹片连接 Quick lock terminal

公 Male	HE-016-MZ	09330162801
母 Female	HE-016-FZ	09330162901

关于直插式弹片连接的优势，详见P00-14



双弹片连接(一针双接线) Cage-clamp terminal (two terminal per contact)

公 Male	HE-016-MSS	09330162672
母 Female	HE-016-FSS	09330162772

1) 接插体之间的最大距离21mm

1) Distance for contact max.21mm

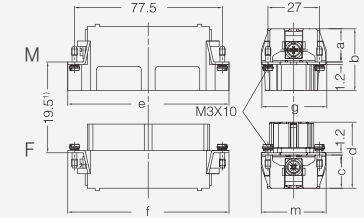

	a	b	e	g	c	d	f	m
M/F	17	32.5	84.2	34	17	34.8	84.5	34
MC/FC	18	33.5	84.5	34	18	35	84.5	34
MS/FS	18	33.7	84.5	34	18.2	35.5	84.5	34
MSS/FSS	34.3	49	84.5	34	32.2	49	84.5	34
MZ/FZ	17.4	34.5	84.5	34	17.2	36.8	84.5	34

接插针排序

Contacts arrangement view from termination side

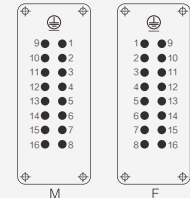

面板安装开孔图

Panel cut out for inserts for use without Hoods/housings

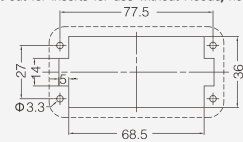

附件 Accessories

16A 冷压针 Crimp contacts

接触电阻 Contact resistance  $\leq 1m\Omega$   
镀银 Silver plated



公 Male	订货号 Part Number	母 Female	订货号 Part Number
CESM-0.37	09330006127	CESF-0.37	09330006227
CESM-0.5	09330006121	CESF-0.5	09330006220
CESM-0.75	09330006114	CESF-0.75	09330006214
CESM-1.0	09330006105	CESF-1.0	09330006205
CESM-1.5	09330006104	CESF-1.5	09330006204
CESM-2.5	09330006102	CESF-2.5	09330006202
CESM-3.0	09330006106	CESF-3.0	09330006206
CESM-4.0	09330006107	CESF-4.0	09330006207

镀金 Gold plated



CEGM-0.37	09330006117	CEGF-0.37	09330006217
CEGM-0.5	09330006122	CEGF-0.5	09330006222
CEGM-0.75	09330006115	CEGF-0.75	09330006215
CEGM-1.0	09330006118	CEGF-1.0	09330006218
CEGM-1.5	09330006116	CEGF-1.5	09330006216
CEGM-2.5	09330006123	CEGF-2.5	09330006223
CEGM-4.0	09330006119	CEGF-4.0	09330006221

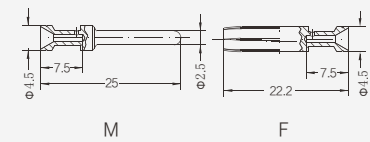

标示 Identification	线规 Wire gauge	剥线长度 Stripping length
no groove	014-0.37mm2 AWG 26-22	7.5mm
no groove	0.5mm2 AWG 20	7.5mm
1 groove	0.75mm2 AWG 18	7.5mm
1 groove	1mm2 AWG 18	7.5mm
2 groove	1.5mm2 AWG 16	7.5mm
3 groove	2.5mm2 AWG 14	7.5mm
wide groove	3mm2 AWG 12	7.5mm
no groove	4mm2 AWG 12	7.5mm

工具 Tools

冷压钳 Crimping tool



压接线经 Wire gauge	型号 Type	订货号 Part Number
0.5-4mm2	TL02G	09990000021

退针器 Removal tool



适用类型 For	型号 Type	订货号 Part Number
16A 冷压针 16A Crimp contacts	TL01	09990000059

更多工具请参考 25-01~25-02页 More tools on P25-01~P25-02



HE-024 常规型插芯 Standard Inserts 500V 16A 24+

插芯 Inserts

外壳尺寸：匹配24B外壳，详情请参考18-01~18-22页

Hoods/Housings：Matching 24B Hood Housing，detail on P18-01~P18-22

螺丝连接 Screw terminal

	插芯 Inserts	型号 Type	订货号 Part Number
	公 Male	HE-024-M	09330242601
	母 Female	HE-024-F	09330242701

冷压连接 Crimp terminal

	插芯 Inserts	型号 Type	订货号 Part Number
	公 Male	HE-024-MC	09330242602
	母 Female	HE-024-FC	09330242702

弹片连接 Cage-clamp

	插芯 Inserts	型号 Type	订货号 Part Number
	公 Male	HE-024-MS	09330242616
	母 Female	HE-024-FS	09330242716



直插式弹片连接 Quick lock terminal

	公 Male	HE-024-MZ	09330242801
	母 Female	HE-024-FZ	09330242901

关于直插式弹片连接的优势，详见P00-14

	双弹片连接(一针双接线) Cage-clamp terminal (two terminal per contact)		
	公 Male	HE-024-MSS	09330242672
	母 Female	HE-024-FSS	09330242772

1) 接插体之间的最大距离21mm

1) Distance for contact max.21mm

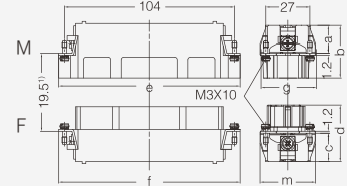

	a	b	e	g	c	d	f	m
M/F	17	32.5	111	34	17	34.8	111.5	34
MC/FC	18.3	33.5	111	34	18.3	36	111.5	34
MS/FS	18.5	33.6	111	34	18.5	36	111.5	34
MSS/FSS	34	49	110	34	32	49	110	34
MZ/FZ	17.4	34.5	111	34	17.2	36.7	111.5	34

接插针排序

Contacts arrangement view from termination side

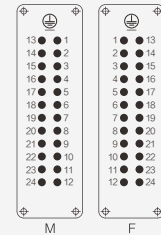

面板安装开孔图

Panel cut out for inserts for use without Hoods/housings

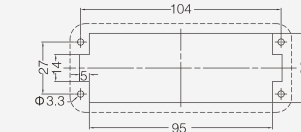

附件 Accessories

16A 冷压针 Crimp contacts

接触电阻 Contact resistance  $\leq 1m\Omega$   
镀银 Silver plated



公 Male	订货号 Part Number	母 Female	订货号 Part Number
CESM-0.37	09330006127	CESF-0.37	09330006227
CESM-0.5	09330006121	CESF-0.5	09330006220
CESM-0.75	09330006114	CESF-0.75	09330006214
CESM-1.0	09330006105	CESF-1.0	09330006205
CESM-1.5	09330006104	CESF-1.5	09330006204
CESM-2.5	09330006102	CESF-2.5	09330006202
CESM-3.0	09330006106	CESF-3.0	09330006206
CESM-4.0	09330006107	CESF-4.0	09330006207

镀金 Gold plated



CEGM-0.37	09330006117	CEGF-0.37	09330006217
CEGM-0.5	09330006122	CEGF-0.5	09330006222
CEGM-0.75	09330006115	CEGF-0.75	09330006215
CEGM-1.0	09330006118	CEGF-1.0	09330006218
CEGM-1.5	09330006116	CEGF-1.5	09330006216
CEGM-2.5	09330006123	CEGF-2.5	09330006223
CEGM-4.0	09330006119	CEGF-4.0	09330006221

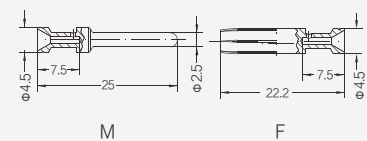

标示 Identification	线规 Wire gauge	剥线长度 Stripping length
no groove	014-0.37mm <sup>2</sup> AWG 26-22	7.5mm
no groove	0.5mm <sup>2</sup> AWG 20	7.5mm
1 groove	0.75mm <sup>2</sup> AWG 18	7.5mm
1 groove	1.1mm <sup>2</sup> AWG 17	7.5mm
2 groove	1.5mm <sup>2</sup> AWG 16	7.5mm
3 groove	2.5mm <sup>2</sup> AWG 14	7.5mm
wide groove	3mm <sup>2</sup> AWG 12	7.5mm
no groove	4mm <sup>2</sup> AWG 12	7.5mm

工具 Tools

冷压钳 Crimping tool



压接线径 Wire gauge	型号 Type	订货号 Part Number
0.5-4mm <sup>2</sup>	TL02G	09990000021

退针器 Removal tool



适用类型 For	型号 Type	订货号 Part Number
16A 冷压针 16A Crimp contacts	TL01	09990000059

更多工具请参考 25-01~25-02页 More tools on P25-01~P25-02



HE-032 常规型插芯 Standard Inserts 500V 16A 32+  $\oplus$

插芯 Inserts

外壳尺寸：匹配32B外壳，详情请参考19-01~19-04页

Hoods/Housings : Matching 32B Hood Housing , detail on P19-01~P19-04

螺丝连接 Screw terminal

	插芯 Inserts	型号 Type	订货号 Part Number
	公 Male	HE-016-M(1-16)	09330162601
		HE-016-M(17-32)	09330162611
	母 Female	HE-016-F(1-16)	09330162701
		HE-016-F(17-32)	09330162711

冷压连接 Crimp terminal

	插芯 Inserts	型号 Type	订货号 Part Number
	公 Male	HE-016-MC(1-16)	09330162602
		HE-016-MC(17-32)	09330162612
	母 Female	HE-016-FC(1-16)	09330162702
		HE-016-FC(17-32)	09330162712

弹片连接 Cage-clamp

	插芯 Inserts	型号 Type	订货号 Part Number
	公 Male	HE-016-MS(1-16)	09330162616
		HE-016-MS(17-32)	09330162626
	母 Female	HE-016-FS(1-16)	09330162716
		HE-016-FS(17-32)	09330162726

NEW

直插式弹片连接 Quick lock terminal

	公 Male	HE-016-MZ(1-16)	09330162801
		HE-016-MZ(17-32)	09330162811
	母 Female	HE-016-FZ(1-16)	09330162901
		HE-016-FZ(17-32)	09330162911

关于直插式弹片连接的优势，详见P00-14

	双弹片连接(一针双接线) Cage-clamp terminal (two terminal per contact)		
	公 Male	HE-016-MSS(1-16)	09330162672
		HE-016-MSS(17-32)	09330162672
	母 Female	HE-016-FSS(1-16)	09330162772
		HE-016-FSS(17-32)	09330162772

1) 接插体之间的最大距离21mm

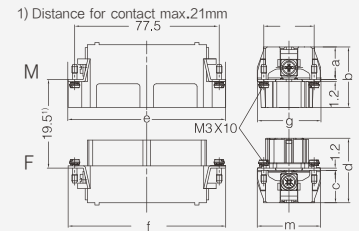

接插针排序

Contacts arrangement view from termination side

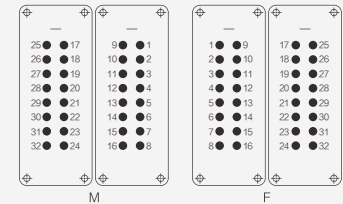

面板安装开孔图

Panel cut out for inserts for use without Hoods/housings

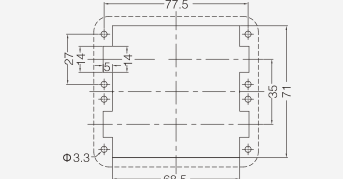

附件 Accessories

16A 冷压针 Crimp contacts

	接触电阻 Contact resistance $\leq 1m\Omega$	公 Male	订货号 Part Number	母 Female	订货号 Part Number
	镀银 Silver plating	CESM-0.37	09330006127	CESF-0.37	09330006227
		CESM-0.5	09330006121	CESF-0.5	09330006220
		CESM-0.75	09330006114	CESF-0.75	09330006214
		CESM-1.0	09330006105	CESF-1.0	09330006205
		CESM-1.5	09330006104	CESF-1.5	09330006204
		CESM-2.5	09330006102	CESF-2.5	09330006202
		CESM-3.0	09330006106	CESF-3.0	09330006206
	CESM-4.0	09330006107	CESF-4.0	09330006207	

镀金 Gold plating

	CEGM-0.37	09330006117	CEGF-0.37	09330006217
	CEGM-0.5	09330006122	CEGF-0.5	09330006222
	CEGM-0.75	09330006115	CEGF-0.75	09330006215
	CEGM-1.0	09330006118	CEGF-1.0	09330006218
	CEGM-1.5	09330006116	CEGF-1.5	09330006216
	CEGM-2.5	09330006123	CEGF-2.5	09330006223
	CEGM-4.0	09330006119	CEGF-4.0	09330006221

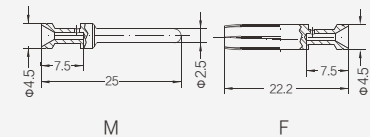

标示 Identification	线规 Wire gauge	剥线长度 Stripping length
no groove	014-0.37mm <sup>2</sup> AWG 26-22	7.5mm
no groove	0.5mm <sup>2</sup> AWG 20	7.5mm
1 groove	0.75mm <sup>2</sup> AWG 18	7.5mm
1 groove	1.1mm <sup>2</sup> AWG 18	7.5mm
2 groove	1.5mm <sup>2</sup> AWG 16	7.5mm
3 groove	2.5mm <sup>2</sup> AWG 14	7.5mm
wide groove	3mm <sup>2</sup> AWG 12	7.5mm
no groove	4mm <sup>2</sup> AWG 12	7.5mm

工具 Tools

	冷压钳 Crimp pin	压接线径 Wire gauge	型号 Type	订货号 Part Number
		0.5-4mm <sup>2</sup>	TL02G	09990000021

	退针器 Removal tool	适用类型 For	型号 Type	订货号 Part Number
		16A 冷压针 16A Crimp contacts	TL01	09990000059

更多工具请参考 25-01~25-02页 More tools on P25-01~P25-02

**Global District Limited**

HE-048 常规型插芯 Standard Inserts 500V 16A 48+

**插芯 Inserts**

外壳尺寸：匹配48B外壳，详情请参考20-01~20-02页

Hoods/Housings：Matching 48B Hood Housing，detail on P20-01~P20-02

**螺丝连接 Screw terminal**

插芯 Inserts	型号 Type	订货号 Part Number
公 Male	HE-024-M(1-24)	09330242601
	HE-024-M(25-48)	09330242611
母 Female	HE-024-F(1-24)	09330242701
	HE-024-F(25-48)	09330242711

**冷压连接 Crimp terminal**

插芯 Inserts	型号 Type	订货号 Part Number
公 Male	HE-024-MC(1-24)	09330242602
	HE-024-MC(25-48)	09330242612
母 Female	HE-024-FC(1-24)	09330242702
	HE-024-FC(25-48)	09330242712

**弹片连接 Cage-clamp**

插芯 Inserts	型号 Type	订货号 Part Number
公 Male	HE-024-MS(1-24)	09330242616
	HE-024-MS(25-48)	09330242626
母 Female	HE-024-FS(1-24)	09330242716
	HE-024-FS(25-48)	09330242726

**NEW**

直插式弹片连接 Quick lock terminal			
公 Male	HE-024-MZ(1-24)	09330242801	
	HE-024-MZ(25-48)	09330242811	
母 Female	HE-024-FZ(1-24)	09330242901	
	HE-024-FZ(25-48)	09330242911	

关于直插式弹片连接的优势，详见P00-14

双弹片连接(一针双接线) Cage-clamp terminal (two terminal per contact)			
公 Male	HE-024-MSS(1-24)	09330242672	
	HE-024-MSS(25-48)	09330242672	
母 Female	HE-024-FSS(1-24)	09330242772	
	HE-024-FSS(25-48)	09330242772	

**1) 接插体之间的最大距离21mm**

1) Distance for contact max.21mm

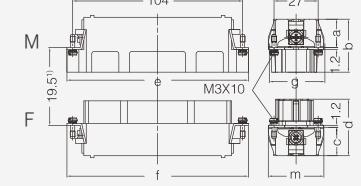

	a	b	e	g	c	d	f	m
M/F	17	32.5	111	34	17	34.8	111.5	34
MC/FC	18.3	33.5	111	34	18.3	36	111.5	34
MS/FS	18.5	33.6	111	34	18.5	36	111.5	34
MSS/FSS	34	49	110	34	32	49	110	34
MZ/FZ	17.4	34.5	111	34	17.2	36.7	111.5	34

**接插针排序**

Contacts arrangement view from termination side

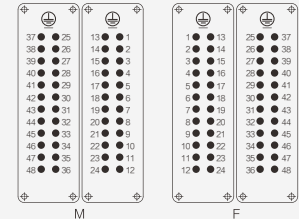
**面板安装开孔图**

Panel cut out for inserts for use without Hoods/housings

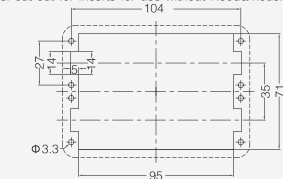
**附件 Accessories**
**16A 冷压针 Crimp contacts**

 接触电阻 Contact resistance  $\leq 1\text{m}\Omega$   
 镀银 Silver plated

公 Male	订货号 Part Number	母 Female	订货号 Part Number
CESM-0.37	09330006127	CESF-0.37	09330006227
CESM-0.5	09330006121	CESF-0.5	09330006220
CESM-0.75	09330006114	CESF-0.75	09330006214
CESM-1.0	09330006105	CESF-1.0	09330006205
CESM-1.5	09330006104	CESF-1.5	09330006204
CESM-2.5	09330006102	CESF-2.5	09330006202
CESM-3.0	09330006106	CESF-3.0	09330006206
CESM-4.0	09330006107	CESF-4.0	09330006207

镀金 Gold plated



公 Male	订货号 Part Number	母 Female	订货号 Part Number
CEGM-0.37	09330006117	CEGF-0.37	09330006217
CEGM-0.5	09330006122	CEGF-0.5	09330006222
CEGM-0.75	09330006115	CEGF-0.75	09330006215
CEGM-1.0	09330006118	CEGF-1.0	09330006218
CEGM-1.5	09330006116	CEGF-1.5	09330006216
CEGM-2.5	09330006123	CEGF-2.5	09330006223
CEGM-4.0	09330006119	CEGF-4.0	09330006221

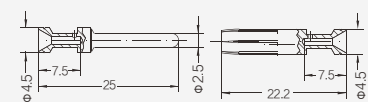

标示 Identification	线规 Wire gauge	剥线长度 Stripping length	
no groove	0.14-0.37mm <sup>2</sup>	AWG 26-22	7.5mm
no groove	0.5mm <sup>2</sup>	AWG 20	7.5mm
1 groove	0.75mm <sup>2</sup>	AWG 18	7.5mm
1 groove	1.1mm <sup>2</sup>	AWG 18	7.5mm
2 groove	1.5mm <sup>2</sup>	AWG 16	7.5mm
3 groove	2.5mm <sup>2</sup>	AWG 14	7.5mm
wide groove	3mm <sup>2</sup>	AWG 12	7.5mm
no groove	4mm <sup>2</sup>	AWG 12	7.5mm

**工具 Tools**
**冷压钳 Crimping tool**

压接线经 Wire gauge	型号 Type	订货号 Part Number
0.5-4mm <sup>2</sup>	TL02G	09990000021

**退针器 Removal tool**

适用类型 For	型号 Type	订货号 Part Number
16A 冷压针	TL01	09990000059
16A Crimp contacts		

更多工具请参考 25-01~25-02页 More tools on P25-01~P25-02



HEE 系列 / HEE SERIES

**技术参数 Technical Characteristics**

规范	Specifications	
规范	Specifications	DIN EN 60 664
		DIN EN 61 984
插芯	Inserts	
依据 EN 61 984的额定电压	Electrical data acc. to EN 61 984	
接插件针数	Number Of Contacts	10,18,32,46,40,64(2X32),92(2X46)+PE
额定电流	Rated Current	16A
额定电压	Rated Voltage	500V
额定脉冲电压	Rated Impulse Voltage	6kV
污染程度	Pollution Degree	3
污染等级2时的参数	Pollution Degree 2 Also	16A 830V 8kV 2
依据UL/CSA额定电压	Rated Voltage Acc.to UI CSA	600V
绝缘电阻	Insulation Resistance	$\geq 10^{10} \Omega$
材料	Material	聚碳酸酯 Polycarbonate
工作温度范围	Limiting Temperatures	-40°C...+125°C
依据UL94阻燃等级	Flammability Acc. To UL94	V0
可拔插次数	MechHEenical Working Life-mating Cycles	$\geq 500$
插针	Contacts	
材料	Material	铜合金 Copper Alloy
表面处理	Surface	镀金 Hard-gold Plated 镀银 Hard-silver Plated
接触电阻	Contact Resistance	$\leq 1m\Omega$
冷压连接	Crimp Terminal	
导线规格	Wire Gauge	0.14-4.0mm <sup>2</sup>
AWG	Awg	26-12
剥线长度	Stripping length	7.5mm

电流负载能力 Current Carrying Capacity

电流负载能力所受的限制主要来自包含接插针的接插体可承受的最大温度

THEE current carrying is limited by maximum temperature of materials for Inserts and contacts including terminals.

测试和控制过程依据 Measuring and testing techniques according to DIN EN 60512-5

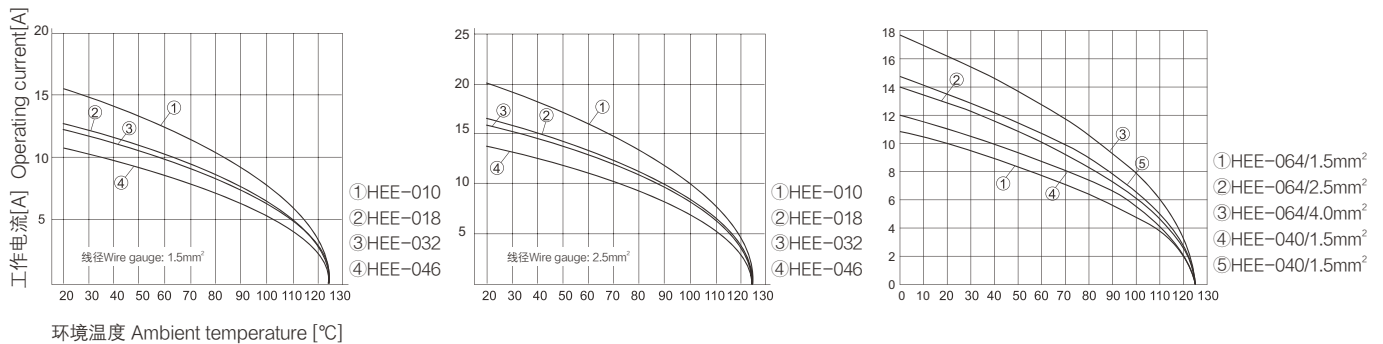



HEE调整插针分布可提高工作电压至1000V / Modified contact arrangement up to 1000V

HEE接插体在装满针时,在绝缘等级3(C)时,其工作电压可达到500V。但其插针分布经过调整,同样在绝缘等级3(C)时,其工作电压允许值可达到1000V。

The connector series HEE equipped with all contacts may be used for voltages up to 500V ~ pollution degree 3. A modified contact loading arrangement permits use up to 1000V ~ pollution degree also in pollution degree C.

调整后插针分布 Contact arrangement view from termination side

690V-绝缘等级3C Pollution degree 3

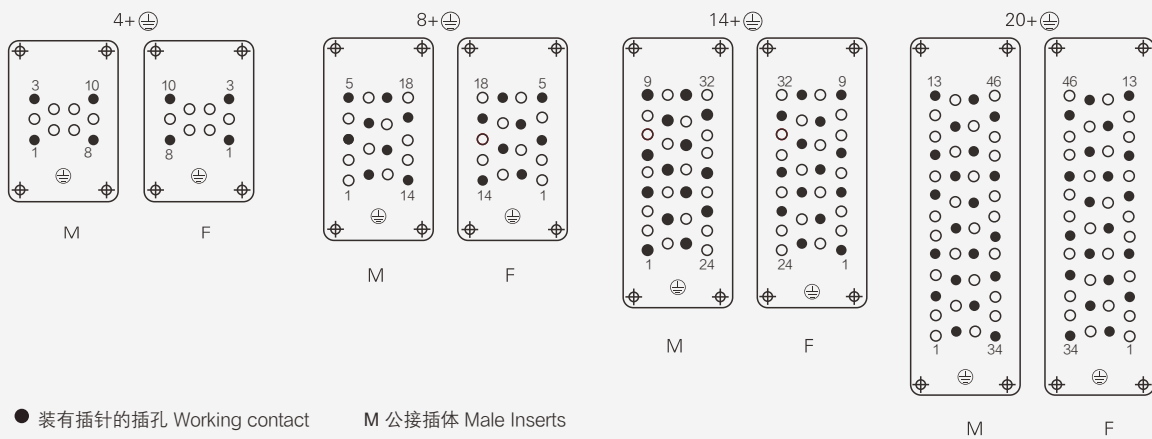

- 装有插针的插孔 Working contact      M 公接插体 Male Inserts
- 不装有插针的插孔 Without contact      F 母接插体 Female Inserts

调整后插针分布 Contact arrangement view from termination side

1000V-绝缘等级3C Pollution degree 3

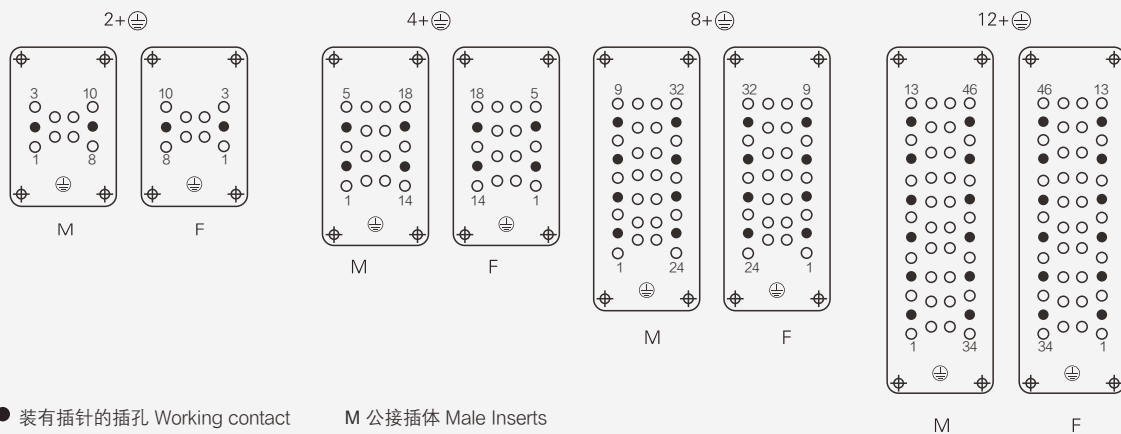

- 装有插针的插孔 Working contact      M 公接插体 Male Inserts
- 不装有插针的插孔 Without contact      F 母接插体 Female Inserts





Global District Limited

HEE-010 高密度型插芯 High-density Inserts 500V 16A 10+

## 插芯 Inserts

外壳尺寸：匹配6B外壳，详情请参考15-01~15-10页

Hoods/Housings：Matching 6B Hood Housing，detail on P15-01~P15-10

冷压连接 Crimp terminal



插芯 Inserts	型号 Type	订货号 Part Number
公 Male	HEE-010-MC	09320103001
母 Female	HEE-010-FC	09320103101

1) 接插体之间的最大距离21mm

1) Distance for contact max.21mm

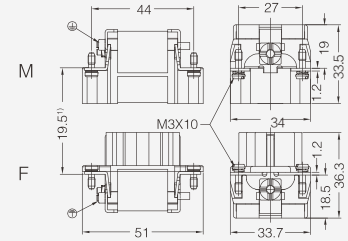

接插针排序

Contacts arrangement view from termination side

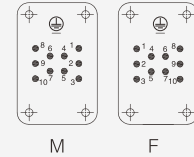

面板安装开孔图

Panel cut out for Inserts for use without Hoods/housings

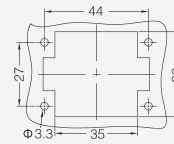

## 附件 Accessories

16A 冷压针 Crimp contacts

接触电阻 Contact resistance  $\leq 1m\Omega$   
镀银 Silver plated



公 Male	订货号 Part Number	母 Female	订货号 Part Number
CESM-0.37	09330006127	CESF-0.37	09330006227
CESM-0.5	09330006121	CESF-0.5	09330006220
CESM-0.75	09330006114	CESF-0.75	09330006214
CESM-1.0	09330006105	CESF-1.0	09330006205
CESM-1.5	09330006104	CESF-1.5	09330006204
CESM-2.5	09330006102	CESF-2.5	09330006202
CESM-3.0	09330006106	CESF-3.0	09330006206
CESM-4.0	09330006107	CESF-4.0	09330006207

镀金 Gold plated



公 Male	订货号 Part Number	母 Female	订货号 Part Number
CEGM-0.37	09330006117	CEGF-0.37	09330006217
CEGM-0.5	09330006122	CEGF-0.5	09330006222
CEGM-0.75	09330006115	CEGF-0.75	09330006215
CEGM-1.0	09330006118	CEGF-1.0	09330006218
CEGM-1.5	09330006116	CEGF-1.5	09330006216
CEGM-2.5	09330006123	CEGF-2.5	09330006223
CEGM-4.0	09330006119	CEGF-4.0	09330006221

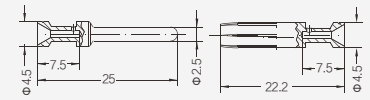

标示 Identification	线规 Wire gauge	剥线长度 Stripping length	
no groove	014-0.37mm <sup>2</sup>	AWG 26-22	7.5mm
no groove	0.5mm <sup>2</sup>	AWG 20	7.5mm
1 groove	0.75mm <sup>2</sup>	AWG 18	7.5mm
1 groove	1mm <sup>2</sup>	AWG 18	7.5mm
2 groove	1.5mm <sup>2</sup>	AWG 16	7.5mm
3 groove	2.5mm <sup>2</sup>	AWG 14	7.5mm
wide groove	3mm <sup>2</sup>	AWG 12	7.5mm
no groove	4mm <sup>2</sup>	AWG 12	7.5mm

工具 Tools

冷压钳 Crimping tool



压接线经 Wire gauge	型号 Type	订货号 Part Number
0.5-4mm <sup>2</sup>	TL02G	09990000021

退针器 Removal tool



适用类型 For	型号 Type	订货号 Part Number
16A 冷压针	TL01	09990000059
16A Crimp contacts		

更多工具请参考 25-01~25-02页 More tools on P25-01~P25-02



HEE-018 高密度型插芯 High-density Inserts 500V 16A 18+

插芯 Inserts

外壳尺寸：匹配10B外壳，详情请参考16-01~16-13页

Hoods/Housings : Matching 10B Hood Housing , detail on P16-01~P16-13

冷压连接 Crimp terminal



插芯 Inserts	型号 Type	订货号 Part Number
公 Male	HEE-018-MC	09320183001
母 Female	HEE-018-FC	09320183101

1) 接插体之间的最大距离21mm  
1) Distance for contact max.21mm

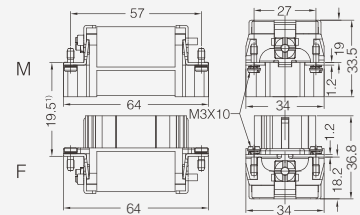

接插针排序

Contacts arrangement view from termination side

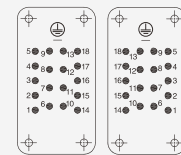

面板安装开孔图

Panel cut out for Inserts for use without Hoods/housings

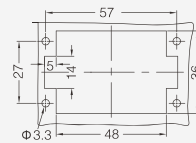

附件 Accessories

16A 冷压针 Crimp contacts

接触电阻 Contact resistance  $\leq 1m\Omega$   
镀银 Silver plated



公 Male	订货号 Part Number	母 Female	订货号 Part Number
CESM-0.37	09330006127	CESF-0.37	09330006227
CESM-0.5	09330006121	CESF-0.5	09330006220
CESM-0.75	09330006114	CESF-0.75	09330006214
CESM-1.0	09330006105	CESF-1.0	09330006205
CESM-1.5	09330006104	CESF-1.5	09330006204
CESM-2.5	09330006102	CESF-2.5	09330006202
CESM-3.0	09330006106	CESF-3.0	09330006206
CESM-4.0	09330006107	CESF-4.0	09330006207

镀金 Gold plated



公 Male	订货号 Part Number	母 Female	订货号 Part Number
CEGM-0.37	09330006117	CEGF-0.37	09330006217
CEGM-0.5	09330006122	CEGF-0.5	09330006222
CEGM-0.75	09330006115	CEGF-0.75	09330006215
CEGM-1.0	09330006118	CEGF-1.0	09330006218
CEGM-1.5	09330006116	CEGF-1.5	09330006216
CEGM-2.5	09330006123	CEGF-2.5	09330006223
CEGM-4.0	09330006119	CEGF-4.0	09330006221

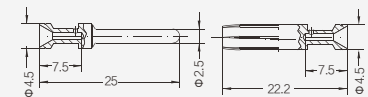

标示 Identification	线规 Wire gauge	剥线长度 Stripping length	
no groove	0.14-0.37mm <sup>2</sup>	AWG 26-22	7.5mm
no groove	0.5mm <sup>2</sup>	AWG 20	7.5mm
1 groove	0.75mm <sup>2</sup>	AWG 18	7.5mm
1 groove	1.0mm <sup>2</sup>	AWG 18	7.5mm
2 groove	1.5mm <sup>2</sup>	AWG 16	7.5mm
3 groove	2.5mm <sup>2</sup>	AWG 14	7.5mm
wide groove	3mm <sup>2</sup>	AWG 12	7.5mm
no groove	4mm <sup>2</sup>	AWG 12	7.5mm

工具 Tools

冷压钳 Crimping tool



压接线经 Wire gauge	型号 Type	订货号 Part Number
0.5-4mm <sup>2</sup>	TL02G	09990000021

退针器 Removal tool



适用类型 For	型号 Type	订货号 Part Number
16A 冷压针 16A Crimp contacts	TL01	09990000059

更多工具请参考 25-01~25-02页 More tools on P25-01~P25-02



Global District Limited

HEE-032 高密度型插芯 High-density Inserts 500V 16A 32+

## 插芯 Inserts

外壳尺寸：匹配16B外壳，详情请参考17-01~17-21页

Hoods/Housings : Matching 16B Hood Housing , detail on P17-01~P17-21

冷压连接 Crimp terminal



插芯 Inserts	型号 Type	订货号 Part Number
公 Male	HEE-032-MC	09320323001
母 Female	HEE-032-FC	09320323101

1) 接插体之间的最大距离21mm

1) Distance for contact max.21mm

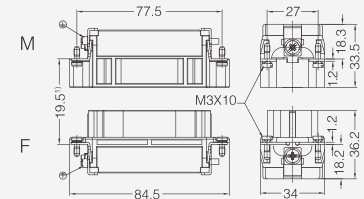

接插针排序

Contacts arrangement view from termination side

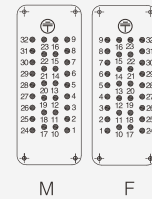

面板安装开孔图

Panel cut out for Inserts for use without Hoods/housings

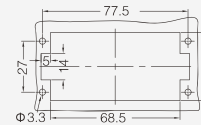

## 附件 Accessories

16A 冷压针 Crimp contacts

接触电阻 Contact resistance  $\leq 1m\Omega$   
镀银 Silver plated



公 Male	订货号 Part Number	母 Female	订货号 Part Number
CESM-0.37	09330006127	CESF-0.37	09330006227
CESM-0.5	09330006121	CESF-0.5	09330006220
CESM-0.75	09330006114	CESF-0.75	09330006214
CESM-1.0	09330006105	CESF-1.0	09330006205
CESM-1.5	09330006104	CESF-1.5	09330006204
CESM-2.5	09330006102	CESF-2.5	09330006202
CESM-3.0	09330006106	CESF-3.0	09330006206
CESM-4.0	09330006107	CESF-4.0	09330006207

镀金 Gold plated



公 Male	订货号 Part Number	母 Female	订货号 Part Number
CEGM-0.37	09330006117	CEGF-0.37	09330006217
CEGM-0.5	09330006122	CEGF-0.5	09330006222
CEGM-0.75	09330006115	CEGF-0.75	09330006215
CEGM-1.0	09330006118	CEGF-1.0	09330006218
CEGM-1.5	09330006116	CEGF-1.5	09330006216
CEGM-2.5	09330006123	CEGF-2.5	09330006223
CEGM-4.0	09330006119	CEGF-4.0	09330006221

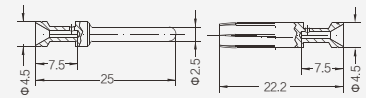

标示 Identification	线规 Wire gauge	剥线长度 Stripping length
no groove	014-0.37mm <sup>2</sup>	AWG 26-22
no groove	0.5mm <sup>2</sup>	AWG 20
1 groove	0.75mm <sup>2</sup>	AWG 18
1 groove	1mm <sup>2</sup>	AWG 18
2 groove	1.5mm <sup>2</sup>	AWG 16
3 groove	2.5mm <sup>2</sup>	AWG 14
wide groove	3mm <sup>2</sup>	AWG 12
no groove	4mm <sup>2</sup>	AWG 12

工具 Tools

冷压钳 Crimping tool



压接线经 Wire gauge	型号 Type	订货号 Part Number
0.5-4mm <sup>2</sup>	TL02G	09990000021

退针器 Removal tool



适用类型 For	型号 Type	订货号 Part Number
16A 冷压针	TL01	09990000059
16A Crimp contacts		

更多工具请参考 25-01~25-02页 More tools on P25-01~P25-02



HEE-046 高密度型插芯 High-density Inserts 500V 16A 46+

插芯 Inserts

外壳尺寸：匹配24B外壳，详情请参考18-01~18-22页

Hoods/Housings：Matching 24B Hood Housing，detail on P18-01~P18-22

冷压连接 Crimp terminal



插芯 Inserts	型号 Type	订货号 Part Number
公 Male	HEE-046-MC	09320463001
母 Female	HEE-046-FC	09320463101

1) 接插体之间的最大距离21mm  
1) Distance for contact max.21mm

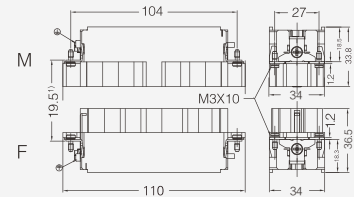

接插针排序

Contacts arrangement view from termination side

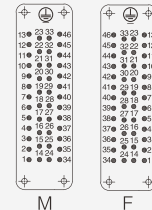

面板安装开孔图

Panel cut out for Inserts for use without Hoods/housings

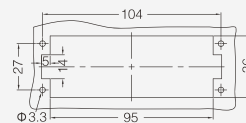

附件 Accessories

16A 冷压针 Crimp contacts

接触电阻 Contact resistance  $\leq 1m\Omega$   
镀银 Silver plated



公 Male	订货号 Part Number	母 Female	订货号 Part Number
CESM-0.37	09330006127	CESF-0.37	09330006227
CESM-0.5	09330006121	CESF-0.5	09330006220
CESM-0.75	09330006114	CESF-0.75	09330006214
CESM-1.0	09330006105	CESF-1.0	09330006205
CESM-1.5	09330006104	CESF-1.5	09330006204
CESM-2.5	09330006102	CESF-2.5	09330006202
CESM-3.0	09330006106	CESF-3.0	09330006206
CESM-4.0	09330006107	CESF-4.0	09330006207

镀金 Gold plated



公 Male	订货号 Part Number	母 Female	订货号 Part Number
CEGM-0.37	09330006117	CEGF-0.37	09330006217
CEGM-0.5	09330006122	CEGF-0.5	09330006222
CEGM-0.75	09330006115	CEGF-0.75	09330006215
CEGM-1.0	09330006118	CEGF-1.0	09330006218
CEGM-1.5	09330006116	CEGF-1.5	09330006216
CEGM-2.5	09330006123	CEGF-2.5	09330006223
CEGM-4.0	09330006119	CEGF-4.0	09330006221

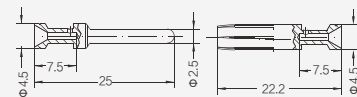

标示 Identification	线规 Wire gauge	剥线长度 Stripping length
no groove	014-0.37mm <sup>2</sup> AWG 26-22	7.5mm
no groove	0.5mm <sup>2</sup> AWG 20	7.5mm
1 groove	0.75mm <sup>2</sup> AWG 18	7.5mm
1 groove	1.1mm <sup>2</sup> AWG 18	7.5mm
2 groove	1.5mm <sup>2</sup> AWG 16	7.5mm
3 groove	2.5mm <sup>2</sup> AWG 14	7.5mm
wide groove	3mm <sup>2</sup> AWG 12	7.5mm
no groove	4mm <sup>2</sup> AWG 12	7.5mm

工具 Tools

冷压钳 Crimping tool



压接线经 Wire gauge	型号 Type	订货号 Part Number
0.5-4mm <sup>2</sup>	TL02G	09990000021

退针器 Removal tool



适用类型 For	型号 Type	订货号 Part Number
16A 冷压针 16A Crimp contacts	TL01	09990000059

更多工具请参考 25-01~25-02页 More tools on P25-01~P25-02



Global District Limited

HEE-064 高密度型插芯 High-density Inserts 500V 16A 64+

## 插芯 Inserts

外壳尺寸：匹配32B外壳，详情请参考19-01~19-04页

Hoods/Housings：Matching 32B Hood Housing，detail on P19-01~P19-04

## 冷压连接 Crimp terminal



插芯 Inserts	型号 Type	订货号 Part Number
公 Male	HEE-032-MC(1-32)	09320323001
	HEE-032-MC(33-64)	09320323011
母 Female	HEE-032-FC(1-32)	09320323101
	HEE-032-FC(33-64)	09320323111

## 1) 接插体之间的最大距离21mm

1) Distance for contact max.21mm

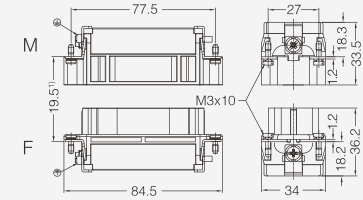

## 接插针排序

Contacts arrangement view from termination side

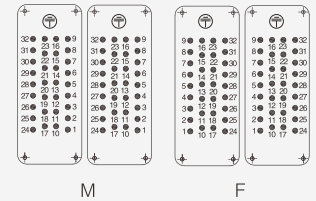

## 面板安装开孔图

Panel cut out for Inserts for use without Hoods/housings

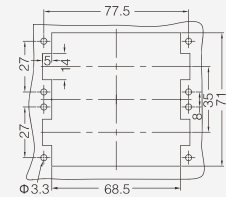

## 附件 Accessories

## 16A 冷压针 Crimp contacts

接触电阻 Contact resistance  $\leq 1\text{m}\Omega$   
镀银 Silver plated

公 Male	订货号 Part Number	母 Female	订货号 Part Number
CESM-0.37	09330006127	CESF-0.37	09330006227
CESM-0.5	09330006121	CESF-0.5	09330006220
CESM-0.75	09330006114	CESF-0.75	09330006214
CESM-1.0	09330006105	CESF-1.0	09330006205
CESM-1.5	09330006104	CESF-1.5	09330006204
CESM-2.5	09330006102	CESF-2.5	09330006202
CESM-3.0	09330006106	CESF-3.0	09330006206
CESM-4.0	09330006107	CESF-4.0	09330006207

镀金 Gold plated



公 Male	订货号 Part Number	母 Female	订货号 Part Number
CEGM-0.37	09330006117	CEGF-0.37	09330006217
CEGM-0.5	09330006122	CEGF-0.5	09330006222
CEGM-0.75	09330006115	CEGF-0.75	09330006215
CEGM-1.0	09330006118	CEGF-1.0	09330006218
CEGM-1.5	09330006116	CEGF-1.5	09330006216
CEGM-2.5	09330006123	CEGF-2.5	09330006223
CEGM-4.0	09330006119	CEGF-4.0	09330006221

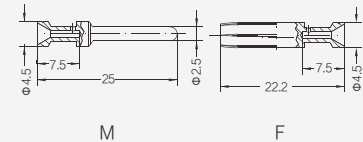

标示 Identification	线规 Wire gauge	剥线长度 Stripping length	
no groove	0.14-0.37mm <sup>2</sup>	AWG 26-22	7.5mm
no groove	0.5mm <sup>2</sup>	AWG 20	7.5mm
1 groove	0.75mm <sup>2</sup>	AWG 18	7.5mm
1 groove	1.0mm <sup>2</sup>	AWG 18	7.5mm
2 groove	1.5mm <sup>2</sup>	AWG 16	7.5mm
3 groove	2.5mm <sup>2</sup>	AWG 14	7.5mm
wide groove	3mm <sup>2</sup>	AWG 12	7.5mm
no groove	4mm <sup>2</sup>	AWG 12	7.5mm

## 工具 Tools

## 冷压钳 Crimping tool



压接线经 Wire gauge	型号 Type	订货号 Part Number
0.5-4mm <sup>2</sup>	TL02G	09990000021

## 退针器 Removal tool



适用类型 For	型号 Type	订货号 Part Number
16A 冷压针	TL01	09990000059
16A Crimp contacts		

更多工具请参考 25-01~25-02页 More tools on P25-01~P25-02



HEE-092 高密度型插芯 High-density Inserts 500V 16A 92+

插芯 Inserts

外壳尺寸：匹配48B外壳，详情请参考20-01~20-02页

Hoods/Housings : Matching 48B Hood Housing , detail on P20-01~P20-02

冷压连接 Crimp terminal



插芯 Inserts	型号 Type	订货号 Part Number
公 Male	HEE-046-MC(1-46)	09320463001
	HEE-046-MC(47-92)	09320463011
母 Female	HEE-046-FC(1-46)	09320463101
	HEE-046-FC(47-92)	09320463111

1) 接插体之间的最大距离21mm

1) Distance for contact max.21mm

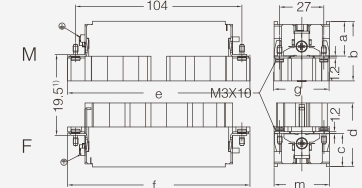

	a	b	e	g	c	d	f	m
M/F	18.5	33.8	110.5	34.4	18.3	36.2	110	34.4
MC/FC	18.3	33.8	110	34	18.2	36.5	110	34

接插针排序

Contacts arrangement view from termination side

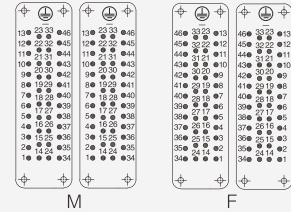

面板安装开孔图

Panel cut out for Inserts for use without Hoods/housings

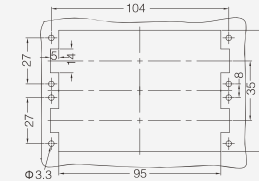

附件 Accessories

16A 冷压针 Crimp contacts

接触电阻 Contact resistance  $\leq 1m\Omega$   
镀银 Silver plated



	公 Male	订货号 Part Number	母 Female	订货号 Part Number
CESM-0.37	09330006127	CESF-0.37	09330006227	
CESM-0.5	09330006121	CESF-0.5	09330006220	
CESM-0.75	09330006114	CESF-0.75	09330006214	
CESM-1.0	09330006105	CESF-1.0	09330006205	
CESM-1.5	09330006104	CESF-1.5	09330006204	
CESM-2.5	09330006102	CESF-2.5	09330006202	
CESM-3.0	09330006106	CESF-3.0	09330006206	
CESM-4.0	09330006107	CESF-4.0	09330006207	

镀金 Gold plated



	公 Male	订货号 Part Number	母 Female	订货号 Part Number
CEGM-0.37	09330006117	CEGF-0.37	09330006217	
CEGM-0.5	09330006122	CEGF-0.5	09330006222	
CEGM-0.75	09330006115	CEGF-0.75	09330006215	
CEGM-1.0	09330006118	CEGF-1.0	09330006218	
CEGM-1.5	09330006116	CEGF-1.5	09330006216	
CEGM-2.5	09330006123	CEGF-2.5	09330006223	
CEGM-4.0	09330006119	CEGF-4.0	09330006221	

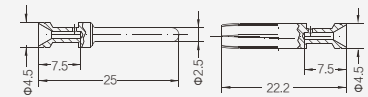

标示 Identification	线规 Wire gauge	剥线长度 Stripping length	
no groove	0.14-0.37mm <sup>2</sup>	AWG 26-22	7.5mm
no groove	0.5mm <sup>2</sup>	AWG 20	7.5mm
1 groove	0.75mm <sup>2</sup>	AWG 18	7.5mm
1 groove	1mm <sup>2</sup>	AWG 18	7.5mm
2 groove	1.5mm <sup>2</sup>	AWG 16	7.5mm
3 groove	2.5mm <sup>2</sup>	AWG 14	7.5mm
wide groove	3mm <sup>2</sup>	AWG 12	7.5mm
no groove	4mm <sup>2</sup>	AWG 12	7.5mm

工具 Tools

冷压钳 Crimping tool



压接线经 Wire gauge	型号 Type	订货号 Part Number
0.5-4mm <sup>2</sup>	TL02G	09990000021

退针器 Removal tool



适用类型 For	型号 Type	订货号 Part Number
16A 冷压针 16A Crimp contacts	TL01	09990000059

更多工具请参考 25-01~25-02页 More tools on P25-01~P25-02

**Global District Limited**

HEEE-040 高密度型插芯 High-density Inserts 500V 16A 40+

**插芯 Inserts**

外壳尺寸：匹配16B外壳，详情请参考17-01~17-21页

Hoods/Housings：Matching 16B Hood Housing，detail on P17-01~P17-21

冷压连接 Crimp terminal



插芯 Inserts	型号 Type	订货号 Part Number
公 Male	HEEE-040-MC	09320403001
母 Female	HEEE-040-FC	09320403101

1) 接插体之间的最大距离21mm

1) Distance for contact max.21mm

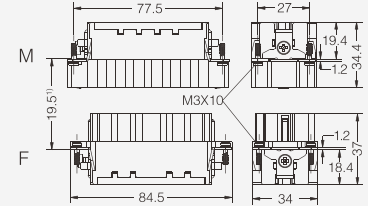
**接插针排序**

Contacts arrangement view from termination side

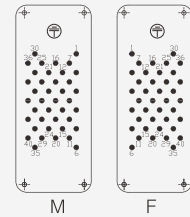
**面板安装开孔图**

Panel cut out for Inserts for use without Hoods/housings

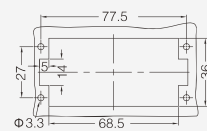
**附件 Accessories**

16A 冷压针 Crimp contacts

 接触电阻 Contact resistance  $\leq 1\text{m}\Omega$   
 镀银 Silver plated

公 Male	订货号 Part Number	母 Female	订货号 Part Number
CESM-0.37	09330006127	CESF-0.37	09330006227
CESM-0.5	09330006121	CESF-0.5	09330006220
CESM-0.75	09330006114	CESF-0.75	09330006214
CESM-1.0	09330006105	CESF-1.0	09330006205
CESM-1.5	09330006104	CESF-1.5	09330006204
CESM-2.5	09330006102	CESF-2.5	09330006202
CESM-3.0	09330006106	CESF-3.0	09330006206
CESM-4.0	09330006107	CESF-4.0	09330006207

镀金 Gold plated



公 Male	订货号 Part Number	母 Female	订货号 Part Number
CEGM-0.37	09330006117	CEGF-0.37	09330006217
CEGM-0.5	09330006122	CEGF-0.5	09330006222
CEGM-0.75	09330006115	CEGF-0.75	09330006215
CEGM-1.0	09330006118	CEGF-1.0	09330006218
CEGM-1.5	09330006116	CEGF-1.5	09330006216
CEGM-2.5	09330006123	CEGF-2.5	09330006223
CEGM-4.0	09330006119	CEGF-4.0	09330006221

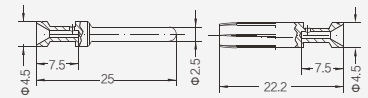

标示 Identification	线规 Wire gauge	剥线长度 Stripping length
no groove	014-0.37mm <sup>2</sup>	AWG 26-22
no groove	0.5mm <sup>2</sup>	AWG 20
1 groove	0.75mm <sup>2</sup>	AWG 18
1 groove	1mm <sup>2</sup>	AWG 18
2 groove	1.5mm <sup>2</sup>	AWG 16
3 groove	2.5mm <sup>2</sup>	AWG 14
wide groove	3mm <sup>2</sup>	AWG 12
no groove	4mm <sup>2</sup>	AWG 12

工具 Tools

冷压钳 Crimping tool



压接线经 Wire gauge	型号 Type	订货号 Part Number
0.5-4mm <sup>2</sup>	TL02G	09990000021

退针器 Removal tool



适用类型 For	型号 Type	订货号 Part Number
16A 冷压针	TL01	09990000059
16A Crimp contacts		

更多工具请参考 25-01~25-02页 More tools on P25-01~P25-02



HEEE-064 高密度型插芯 High-density Inserts 500V 16A 64+ ⊕

插芯 Inserts

外壳尺寸：匹配24B外壳，详情请参考18-01~18-22页

Hoods/Housings : Matching 24B Hood Housing , detail on P18-01~P18-22

冷压连接 Crimp terminal

插芯 Inserts	型号 Type	订货号 Part Number
公 Male	HEEE-064-MC	09320643001
母 Female	HEEE-064-FC	09320643101

1) 接插体之间的最大距离21mm  
1) Distance for contact max.21mm

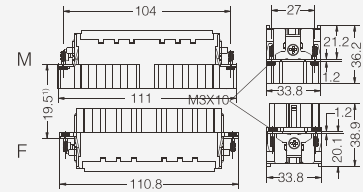

接插针排序  
Contacts arrangement view from termination side

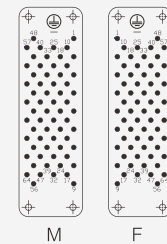

面板安装开孔图  
Panel cut out for Inserts for use without Hoods/housings

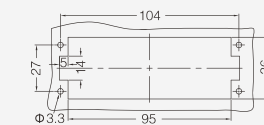

附件 Accessories

16A 冷压针 Crimp contacts

接触电阻 Contact resistance  $\leq 1m\Omega$   
镀银 Silver plated



公 Male	订货号 Part Number	母 Female	订货号 Part Number
CESM-0.37	09330006127	CESF-0.37	09330006227
CESM-0.5	09330006121	CESF-0.5	09330006220
CESM-0.75	09330006114	CESF-0.75	09330006214
CESM-1.0	09330006105	CESF-1.0	09330006205
CESM-1.5	09330006104	CESF-1.5	09330006204
CESM-2.5	09330006102	CESF-2.5	09330006202
CESM-3.0	09330006106	CESF-3.0	09330006206
CESM-4.0	09330006107	CESF-4.0	09330006207

镀金 Gold plated



公 Male	订货号 Part Number	母 Female	订货号 Part Number
CEGM-0.37	09330006117	CEGF-0.37	09330006217
CEGM-0.5	09330006122	CEGF-0.5	09330006222
CEGM-0.75	09330006115	CEGF-0.75	09330006215
CEGM-1.0	09330006118	CEGF-1.0	09330006218
CEGM-1.5	09330006116	CEGF-1.5	09330006216
CEGM-2.5	09330006123	CEGF-2.5	09330006223
CEGM-4.0	09330006119	CEGF-4.0	09330006221

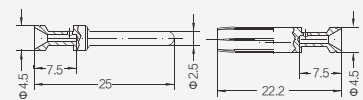

标示 Identification	线规 Wire gauge	剥线长度 Stripping length
no groove	014-0.37mm <sup>2</sup> AWG 26-22	7.5mm
no groove	0.5mm <sup>2</sup> AWG 20	7.5mm
1 groove	0.75mm <sup>2</sup> AWG 18	7.5mm
1 groove	1.0mm <sup>2</sup> AWG 18	7.5mm
2 groove	1.5mm <sup>2</sup> AWG 16	7.5mm
3 groove	2.5mm <sup>2</sup> AWG 14	7.5mm
wide groove	3mm <sup>2</sup> AWG 12	7.5mm
no groove	4mm <sup>2</sup> AWG 12	7.5mm

工具 Tools

冷压钳 Crimping tool



压接线经 Wire gauge	型号 Type	订货号 Part Number
0.5-4mm <sup>2</sup>	TL02G	09990000021

退针器 Removal tool



适用类型 For	型号 Type	订货号 Part Number
16A 冷压针 16A Crimp contacts	TL01	09990000059

更多工具请参考 25-01~25-02页 More tools on P25-01~P25-02





HD 系列 / HD SERIES

技术参数 Technical Characteristics

规范	Specifications	
规范	Specifications	DIN EN 60 664 DIN EN 61 984
插芯	Inserts	
依据 EN 61 984的额定电压	Electrical data acc. to EN 61 984	
接插件针数	Number Of Contacts	7,8,15,25,40,50(25X2),,64,80(40X2),128(64x2)+PE
额定电流	Rated Current	10A
额定电压	Rated Voltage	250V
额定脉冲电压	Rated Impulse Voltage	4kV
污染程度	Pollution Degree	3
污染等级2时的参数	Pollution Degree 2 Also	10A 230/400V 4kV 2
依据UL/CSA额定电压	Rated Voltage Acc.to UI CSA	600V
依据CSA绕线连接的额定电压	Rated Voltage For Wrap Terminal Acc. To CSA	2A 30V
HD-008的电气数据		
额定电流	Rated Current	10A
额定电压	Rated Voltage	~50V~120V
额定脉冲电压	Rated Impulse Voltage	4kV
污染程度	Pollution Degree	3
依据UL/CSA额定电压	Rated Voltage Acc.to UI CSA	50V
额定电压 ( 直流电压 )	Rated Voltage	120V
绝缘电阻	Insulation Resistance	$\geq 10^{10} \Omega$
材料	Material	聚碳酸酯 Polycarbonate
工作温度范围	Limiting Temperatures	-40°C...+125°C
依据UL94阻燃等级	Flammability Acc. To UL94	V0
可拔插次数	Mechanical Working Life-mating Cycles	$\geq 500$
插针	Contacts	
材料	Material	铜合金 Copper Alloy
表面处理	Surface	镀金 Hard-gold Plated 镀银 Hard-silver Plated
接触电阻	Contact Resistance	$\leq 3m \Omega$
冷压连接	Screw Terminal	
导线规格	Wire Gauge	0.14-2.5mm <sup>2</sup>
AWG	AWG	26-14

电流负载能力 Current Carrying Capacity

电流负载能力所受的限制主要来自包含接插针的接插体可承受的最大温度

The current carrying is limited by maximum temperature of materials for Inserts and contacts including terminals.

测试和控制过程依据 Measuring and testing techniques according to DIN EN 60512-5

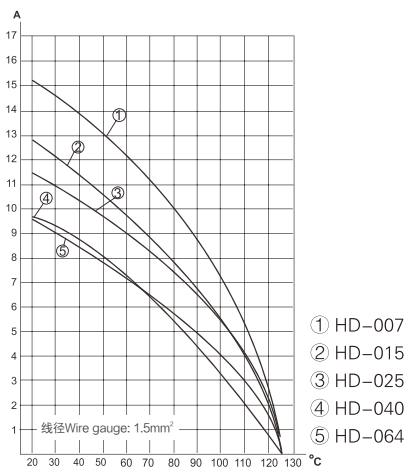
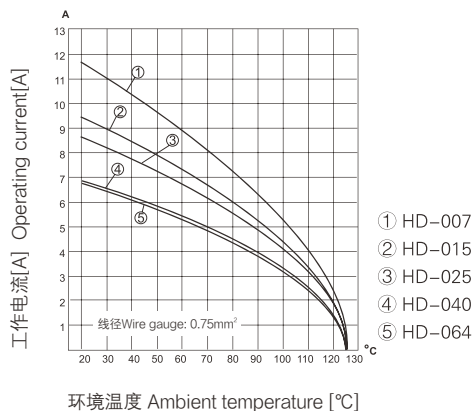



**Global District Limited**

HD调整插针分布可提高工作电压至500V / Modified contact arrangement up to 500V

HD接插体在装满针时,在绝缘等级3(C)时,其工作电压可达到250V。但其插针分布经过调整,同样在绝缘等级3(C)时,其工作电压允许值可达到500V。

The connector series HD equipped with all contacts may be used for voltages up to 250V ~ pollution degree 3.A modified contact loading arrangement permits use up to 500V ~ pollution degree also in pollution degree C.

调整后插针分布 Contact arrangement view from termination side

10A 500V 6kV 3

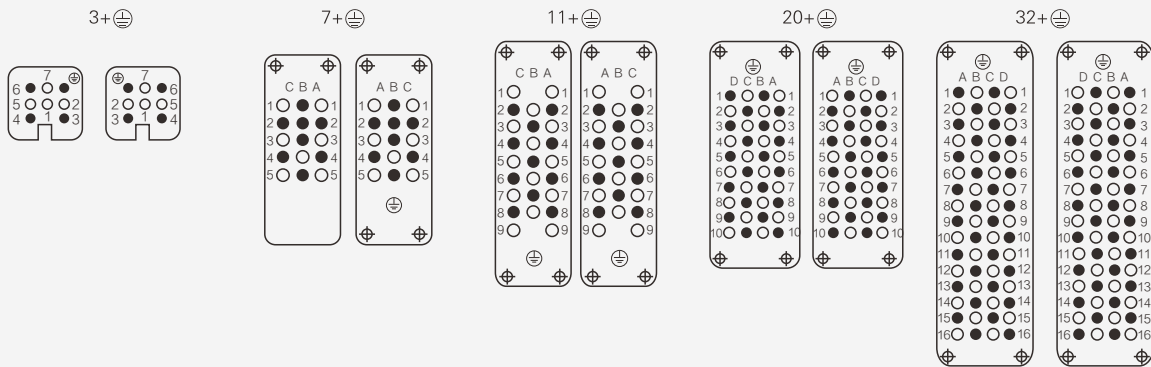

- 装有插针的插孔 Working contact      M 公接插体 Male insert
- 不装有插针的插孔 Without contact      F 母接插体 Female insert



Global District Limited

HD-007 超高密度型插芯 Ultra-high Density Inserts 250V 10A 7+

插芯 Inserts

外壳尺寸：匹配10A外壳，详情请参12-01~12-02页

Hoods/Housings：Matching 10A Hood Housing，detail onP12-01~P12-02

冷压连接 Crimp terminal



插芯 Inserts	型号 Type	订货号 Part Number
公 Male	HD-007-MC	09210073031
母 Female	HD-007-FC	09210073131

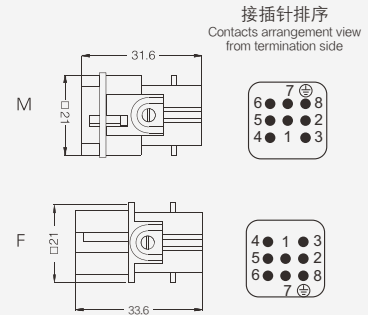

快速上锁 Quick lock



插芯 Inserts	型号 Type	订货号 Part Number
公 Male	HD-007-MQ	09210072632
母 Female	HD-007-FQ	09210072732

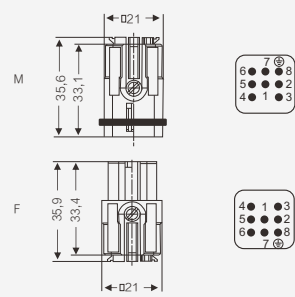

附件 Accessories

10A 冷压针 Crimp contacts

接触电阻 Contact resistance  $\leq 3m\Omega$   
镀银 Silver plated



公 Male	订货号 Part Number	母 Female	订货号 Part Number
CDSM-0.37	09150006104	CDSF-0.37	09150006204
CDSM-0.5	09150006103	CDSF-0.5	09150006203
CDSM-0.75	09150006105	CDSF-0.75	09150006205
CDSM-1.0	09150006102	CDSF-1.0	09150006202
CDSM-1.5	09150006101	CDSF-1.5	09150006201
CDSM-2.5	09150006106	CDSF-2.5	09150006206

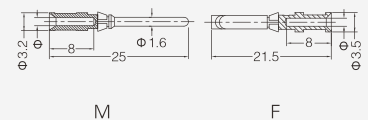

镀金 Gold plated



公 Male	订货号 Part Number	母 Female	订货号 Part Number
CDGM-0.37	09150006124	CDGF-0.37	09150006224
CDGM-0.5	09150006123	CDGF-0.5	09150006223
CDGM-0.75	09150006125	CDGF-0.75	09150006225
CDGM-1.0	09150006122	CDGF-1.0	09150006222
CDGM-1.5	09150006121	CDGF-1.5	09150006221
CDGM-2.5	09150006126	CDGF-2.5	09150006226

线规 Wire gauge	$\phi$	剥线长度 Stripping length
0.14-0.37 mm <sup>2</sup>	0.9	8 mm
0.5 mm <sup>2</sup>	1.1	8 mm
0.75 mm <sup>2</sup>	1.3	8 mm
1 mm <sup>2</sup>	1.45	8 mm
1.5 mm <sup>2</sup>	1.75	8 mm
2.5 mm <sup>2</sup>	2.25	6 mm

工具 Tools

冷压钳 Crimping tool



压接线经 Wire gauge	型号 Type	订货号 Part Number
0.14-4mm <sup>2</sup>	TL02G	09990000021

退针器 Removal tool



适用类型 For	型号 Type	订货号 Part Number
10A 冷压针 10A Crimp contacts	TL00	09990000012

更多工具请参考 25-01~25-02页 More tools on P25-01~P25-02



**Global District Limited**

HD-008 超高密度型插芯 Ultra-high Density Inserts -120V/~50V 10A 8+

**插芯 Inserts**

外壳尺寸：匹配3A外壳，详情请参考11-05~11-11页

Hoods/Housings : Matching 3A Hood Housing , detail on P11-05~P11-11

冷压连接 Crimp terminal



插芯 Inserts	型号 Type	订货号 Part Number
公 Male	HD-008-MC	09360083001
母 Female	HD-008-FC	09360083101

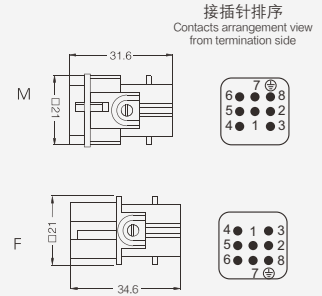

快速上锁 Quick lock



插芯 Inserts	型号 Type	订货号 Part Number
公 Male	HD-008-MQ	09360082632
母 Female	HD-008-FQ	09360082732

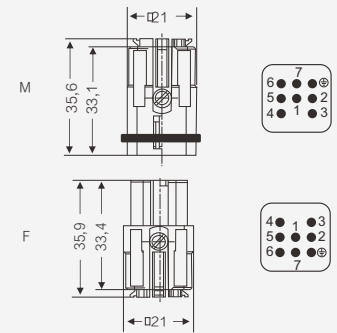

**附件 Accessories**

10A 冷压针 Crimp contacts

接触电阻 Contact resistance  $\leq 3m\Omega$   
镀银 Silver plated



公 Male	订货号 Part Number	母 Female	订货号 Part Number
CDSM-0.37	09150006104	CDSF-0.37	09150006204
CDSM-0.5	09150006103	CDSF-0.5	09150006203
CDSM-0.75	09150006105	CDSF-0.75	09150006205
CDSM-1.0	09150006102	CDSF-1.0	09150006202
CDSM-1.5	09150006101	CDSF-1.5	09150006201
CDSM-2.5	09150006106	CDSF-2.5	09150006206

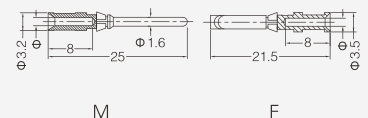

镀金 Gold plated



公 Male	订货号 Part Number	母 Female	订货号 Part Number
CDGM-0.37	09150006124	CDGF-0.37	09150006224
CDGM-0.5	09150006123	CDGF-0.5	09150006223
CDGM-0.75	09150006125	CDGF-0.75	09150006225
CDGM-1.0	09150006122	CDGF-1.0	09150006222
CDGM-1.5	09150006121	CDGF-1.5	09150006221
CDGM-2.5	09150006126	CDGF-2.5	09150006226

线规 Wire gauge	$\Phi$	剥线长度 Stripping length
0.14-0.37 mm <sup>2</sup>	AWG 26-22	0.9 8 mm
0.5 mm <sup>2</sup>	AWG 20	1.1 8 mm
0.75 mm <sup>2</sup>	AWG 18	1.3 8 mm
1 mm <sup>2</sup>	AWG 18	1.45 8 mm
1.5 mm <sup>2</sup>	AWG 16	1.75 8 mm
2.5 mm <sup>2</sup>	AWG 14	2.25 6 mm

工具 Tools

冷压钳 Crimping tool



压接线经 Wire gauge	型号 Type	订货号 Part Number
0.14-4mm <sup>2</sup>	TL02G	09990000021

退针器 Removal tool



适用类型 For	型号 Type	订货号 Part Number
10A 冷压针 10A Crimp contacts	TL00	09990000012

更多工具请参考 25-01~25-02页 More tools on P25-01~P25-02



**Global District Limited**

HD-015 超高密度型插芯 Ultra-high Density Inserts 250V 10A 15+

**插芯 Inserts**

外壳尺寸：匹配10A外壳，详情请参12-01~12-02页

Hoods/Housings：Matching 10A Hood Housing，detail on P12-01~P12-02

冷压连接 Crimp terminal



插芯 Inserts	型号 Type	订货号 Part Number
公 Male	HD-015-MC	09210153001
母 Female	HD-015-FC	09210153101

1) 接插体之间的最大距离24mm  
1) Distance for contact max.24mm

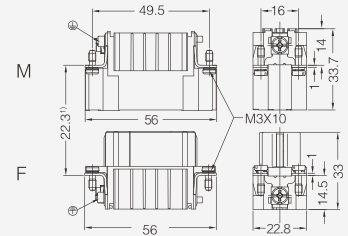

**接插针排序**

Contacts arrangement view from termination side

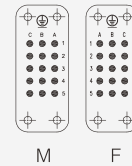

**面板安装开孔图**

Panel cut out for inserts for use without Hoods/housings

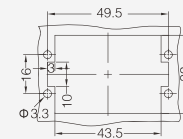

**附件 Accessories**

10A 冷压针 Crimp contacts

接触电阻 Contact resistance  $\leq 3m\Omega$   
镀银 Silver plated



公 Male	订货号 Part Number	母 Female	订货号 Part Number
CDSM-0.37	09150006104	CDSF-0.37	09150006204
CDSM-0.5	09150006103	CDSF-0.5	09150006203
CDSM-0.75	09150006105	CDSF-0.75	09150006205
CDSM-1.0	09150006102	CDSF-1.0	09150006202
CDSM-1.5	09150006101	CDSF-1.5	09150006201
CDSM-2.5	09150006106	CDSF-2.5	09150006206

镀金 Gold plated



公 Male	订货号 Part Number	母 Female	订货号 Part Number
CDGM-0.37	09150006124	CDGF-0.37	09150006224
CDGM-0.5	09150006123	CDGF-0.5	09150006223
CDGM-0.75	09150006125	CDGF-0.75	09150006225
CDGM-1.0	09150006122	CDGF-1.0	09150006222
CDGM-1.5	09150006121	CDGF-1.5	09150006221
CDGM-2.5	09150006126	CDGF-2.5	09150006226

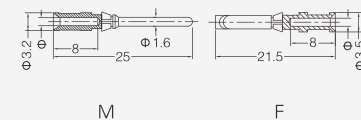

线规 Wire gauge	$\Phi$	剥线长度 Stripping length
0.14-0.37 mm <sup>2</sup>	AWG 26-22	0.9
0.5 mm <sup>2</sup>	AWG 20	1.1
0.75 mm <sup>2</sup>	AWG 18	1.3
1 mm <sup>2</sup>	AWG 18	1.45
1.5 mm <sup>2</sup>	AWG 16	1.75
2.5 mm <sup>2</sup>	AWG 14	2.25

工具 Tools

冷压钳 Crimping tool



压接线经 Wire gauge	型号 Type	订货号 Part Number
0.14-4mm <sup>2</sup>	TL02G	09990000021

退针器 Removal tool



适用类型 For	型号 Type	订货号 Part Number
10A 冷压针 10A Crimp contacts	TL00	09990000012

更多工具请参考 25-01~25-02页 More tools on P25-01~P25-02



**Global District Limited**

HD-025 超高密度型插芯 Ultra-high Density Inserts 250V 10A 25+

**插芯 Inserts**

外壳尺寸：匹配16A外壳，详情请参考13-01~13-02页

Hoods/Housings：Matching 16A Hood Housing，detail on P13-01~P13-02

冷压连接 Crimp terminal



插芯 Inserts	型号 Type	订货号 Part Number
公 Male	HD-025-MC	09210253001
母 Female	HD-025-FC	09210253101

1) 接插体之间的最大距离24mm

1) Distance for contact max.24mm

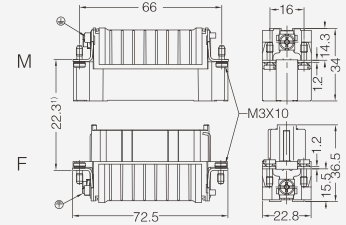

接插针排序

Contacts arrangement view from termination side

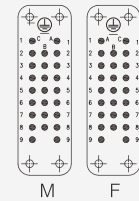

面板安装开孔图

Panel cut out for inserts for use without Hoods/housings

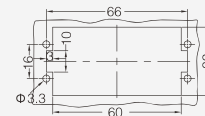

**附件 Accessories**

10A 冷压针 Crimp contacts

接触电阻 Contact resistance  $\leq 3m\Omega$   
镀银 Silver plated



公 Male	订货号 Part Number	母 Female	订货号 Part Number
CDSM-0.37	09150006104	CDSF-0.37	09150006204
CDSM-0.5	09150006103	CDSF-0.5	09150006203
CDSM-0.75	09150006105	CDSF-0.75	09150006205
CDSM-1.0	09150006102	CDSF-1.0	09150006202
CDSM-1.5	09150006101	CDSF-1.5	09150006201
CDSM-2.5	09150006106	CDSF-2.5	09150006206

镀金 Gold plated



公 Male	订货号 Part Number	母 Female	订货号 Part Number
CDGM-0.37	09150006124	CDGF-0.37	09150006224
CDGM-0.5	09150006123	CDGF-0.5	09150006223
CDGM-0.75	09150006125	CDGF-0.75	09150006225
CDGM-1.0	09150006122	CDGF-1.0	09150006222
CDGM-1.5	09150006121	CDGF-1.5	09150006221
CDGM-2.5	09150006126	CDGF-2.5	09150006226

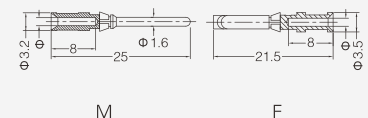

线规 Wire gauge	$\Phi$	剥线长度 Stripping length
0.14-0.37 mm <sup>2</sup>	AWG 26-22	0.9 8 mm
0.5 mm <sup>2</sup>	AWG 20	1.1 8 mm
0.75 mm <sup>2</sup>	AWG 18	1.3 8 mm
1 mm <sup>2</sup>	AWG 18	1.45 8 mm
1.5 mm <sup>2</sup>	AWG 16	1.75 8 mm
2.5 mm <sup>2</sup>	AWG 14	2.25 6 mm

工具 Tools

冷压钳 Crimping tool



压接线经 Wire gauge	型号 Type	订货号 Part Number
0.14-4mm <sup>2</sup>	TL02G	09990000021

退针器 Removal tool



适用类型 For	型号 Type	订货号 Part Number
10A 冷压针	TL00	09990000012
10A Crimp contacts		

更多工具请参考 25-01~25-02页 More tools on P25-01~P25-02



HD-040 超高密度型插芯 Ultra-high Density Inserts 250V 10A 40+

插芯 Inserts

外壳尺寸：匹配16B外壳，详情请参考17-01~17-21页

Hoods/Housings：Matching 16B Hood Housing，detail on P17-01~P17-21

冷压连接 Crimp terminal



插芯 Inserts	型号 Type	订货号 Part Number
公 Male	HD-040-MC	09210403001
母 Female	HD-040-FC	09210403101

1) 接插体之间的最大距离24mm

1) Distance for contact max.24mm

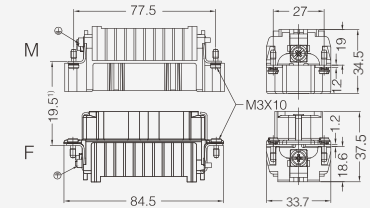

接插针排序

Contacts arrangement view from termination side

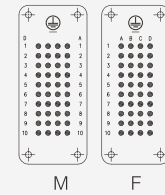

面板安装开孔图

Panel cut out for inserts for use without Hoods/housings

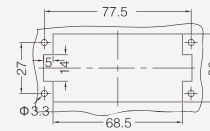

附件 Accessories

10A 冷压针 Crimp contacts

接触电阻 Contact resistance  $\leq 3m\Omega$   
镀银 Silver plated



公 Male	订货号 Part Number	母 Female	订货号 Part Number
CDSM-0.37	09150006104	CDSF-0.37	09150006204
CDSM-0.5	09150006103	CDSF-0.5	09150006203
CDSM-0.75	09150006105	CDSF-0.75	09150006205
CDSM-1.0	09150006102	CDSF-1.0	09150006202
CDSM-1.5	09150006101	CDSF-1.5	09150006201
CDSM-2.5	09150006106	CDSF-2.5	09150006206

镀金 Gold plated



公 Male	订货号 Part Number	母 Female	订货号 Part Number
CDGM-0.37	09150006124	CDGF-0.37	09150006224
CDGM-0.5	09150006123	CDGF-0.5	09150006223
CDGM-0.75	09150006125	CDGF-0.75	09150006225
CDGM-1.0	09150006122	CDGF-1.0	09150006222
CDGM-1.5	09150006121	CDGF-1.5	09150006221
CDGM-2.5	09150006126	CDGF-2.5	09150006226

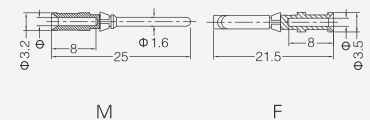

线规 Wire gauge	$\Phi$	剥线长度 Stripping length
0.14-0.37 mm <sup>2</sup>	AWG 26-22	0.9 8 mm
0.5 mm <sup>2</sup>	AWG 20	1.1 8 mm
0.75 mm <sup>2</sup>	AWG 18	1.3 8 mm
1 mm <sup>2</sup>	AWG 18	1.45 8 mm
1.5 mm <sup>2</sup>	AWG 16	1.75 8 mm
2.5 mm <sup>2</sup>	AWG 14	2.25 6 mm

工具 Tools

冷压钳 Crimping tool



压接线经 Wire gauge	型号 Type	订货号 Part Number
0.14-4mm <sup>2</sup>	TL02G	09990000021

退针器 Removal tool



适用类型 For	型号 Type	订货号 Part Number
10A 冷压针 10A Crimp contacts	TL00	09990000012

更多工具请参考 25-01~25-02页 More tools on P25-01~P25-02



**Global District Limited**

HD-050 超高密度型插芯 Ultra-high Density Inserts 250V 10A 50+  $\oplus$

**插芯 Inserts**

外壳尺寸：匹配32A外壳，详情请参考14-01~14-02页

Hoods/Housings：Matching 32A Hood Housing，detail on P14-01~P14-02

冷压连接 Crimp terminal



插芯 Inserts	型号 Type	订货号 Part Number
公 Male	HD-025-MC(1-25)	09210253001
	HD-025-MC(1-25)	09210253001
母 Female	HD-025-FC(1-25)	09210253101
	HD-025-FC(1-25)	09210253101

1) 接插体之间的最大距离24mm

1) Distance for contact max.24mm

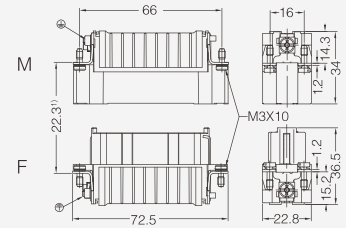

接插针排序

Contacts arrangement view from termination side

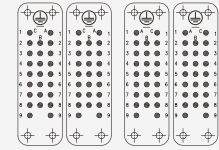

面板安装开孔图

Panel cut out for inserts for use without Hoods/housings

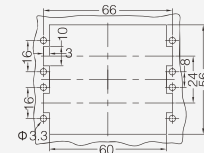

**附件 Accessories**

10A 冷压针 Crimp contacts

接触电阻 Contact resistance  $\leq 3m\Omega$   
镀银 Silver plated



公 Male	订货号 Part Number	母 Female	订货号 Part Number
CDSM-0.37	09150006104	CDSF-0.37	09150006204
CDSM-0.5	09150006103	CDSF-0.5	09150006203
CDSM-0.75	09150006105	CDSF-0.75	09150006205
CDSM-1.0	09150006102	CDSF-1.0	09150006202
CDSM-1.5	09150006101	CDSF-1.5	09150006201
CDSM-2.5	09150006106	CDSF-2.5	09150006206

镀金 Gold plated



公 Male	订货号 Part Number	母 Female	订货号 Part Number
CDGM-0.37	09150006124	CDGF-0.37	09150006224
CDGM-0.5	09150006123	CDGF-0.5	09150006223
CDGM-0.75	09150006125	CDGF-0.75	09150006225
CDGM-1.0	09150006122	CDGF-1.0	09150006222
CDGM-1.5	09150006121	CDGF-1.5	09150006221
CDGM-2.5	09150006126	CDGF-2.5	09150006226

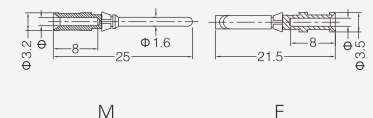

线规 Wire gauge	$\Phi$	剥线长度 Stripping length
0.14-0.37 mm <sup>2</sup> AWG 26-22	0.9	8 mm
0.5 mm <sup>2</sup> AWG 20	1.1	8 mm
0.75 mm <sup>2</sup> AWG 18	1.3	8 mm
1 mm <sup>2</sup> AWG 18	1.45	8 mm
1.5 mm <sup>2</sup> AWG 16	1.75	8 mm
2.5 mm <sup>2</sup> AWG 14	2.25	6 mm

工具 Tools

冷压钳 Crimping tool



压接线经 Wire gauge	型号 Type	订货号 Part Number
0.14-4mm <sup>2</sup>	TL02G	09990000021

退针器 Removal tool



适用类型 For	型号 Type	订货号 Part Number
10A 冷压针	TL00	09990000012
10A Crimp contacts		

更多工具请参考 25-01~25-02页 More tools on P25-01~P25-02





HD-064 超高密度型插芯 Ultra-high Density Inserts 250V 10A 64+

**插芯 Inserts**

外壳尺寸：匹配24B外壳，详情请参考18-01~18-22页

Hoods/Housings：Matching 24B Hood Housing，detail on P18-01~P18-22

冷压连接 Crimp terminal



插芯 Inserts	型号 Type	订货号 Part Number
公 Male	HD-064-MC	09210643001
母 Female	HD-064-FC	09210643101

1) 接插体之间的最大距离24mm

1) Distance for contact max.24mm

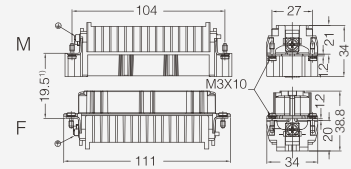

接插针排序

Contacts arrangement view from termination side

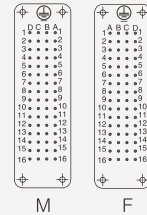

面板安装开孔图

Panel cut out for inserts for use without Hoods/housings

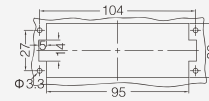

**附件 Accessories**

10A 冷压针 Crimp contacts

接触电阻 Contact resistance  $\leq 3m\Omega$   
镀银 Silver plated



公 Male	订货号 Part Number	母 Female	订货号 Part Number
CDSM-0.37	09150006104	CDSF-0.37	09150006204
CDSM-0.5	09150006103	CDSF-0.5	09150006203
CDSM-0.75	09150006105	CDSF-0.75	09150006205
CDSM-1.0	09150006102	CDSF-1.0	09150006202
CDSM-1.5	09150006101	CDSF-1.5	09150006201
CDSM-2.5	09150006106	CDSF-2.5	09150006206

镀金 Gold plated



公 Male	订货号 Part Number	母 Female	订货号 Part Number
CDGM-0.37	09150006124	CDGF-0.37	09150006224
CDGM-0.5	09150006123	CDGF-0.5	09150006223
CDGM-0.75	09150006125	CDGF-0.75	09150006225
CDGM-1.0	09150006122	CDGF-1.0	09150006222
CDGM-1.5	09150006121	CDGF-1.5	09150006221
CDGM-2.5	09150006126	CDGF-2.5	09150006226

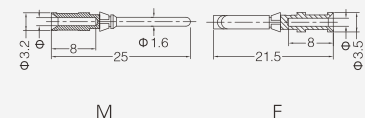

线规 Wire gauge	$\Phi$	剥线长度 Stripping length
0.14-0.37 mm <sup>2</sup>	AWG 26-22	0.9
0.5 mm <sup>2</sup>	AWG 20	1.1
0.75 mm <sup>2</sup>	AWG 18	1.3
1 mm <sup>2</sup>	AWG 18	1.45
1.5 mm <sup>2</sup>	AWG 16	1.75
2.5 mm <sup>2</sup>	AWG 14	2.25

工具 Tools

冷压钳 Crimping tool



压接线径 Wire gauge	型号 Type	订货号 Part Number
0.14-4mm <sup>2</sup>	TL02G	09990000021

退针器 Removal tool



适用类型 For	型号 Type	订货号 Part Number
10A 冷压针 10A Crimp contacts	TL00	09990000012

更多工具请参考 25-01~25-02页 More tools on P25-01~P25-02



**Global District Limited**

HD-080 超高密度型插芯 Ultra-high Density Inserts 250V 10A 80+

**插芯 Inserts**

外壳尺寸：匹配32B外壳，详情请参考19-01~19-04页

Hoods/Housings：Matching 32B Hood Housing，detail on P19-01~P19-04

冷压连接 Crimp terminal



插芯 Inserts	型号 Type	订货号 Part Number
公 Male	HD-040-MC(1-40)	09210403001
	HD-040-MC(1-40)	09210403001
母 Female	HD-040-FC(1-40)	09210403101
	HD-040-FC(1-40)	09210403101

1) 接插体之间的最大距离24mm

1) Distance for contact max.24mm

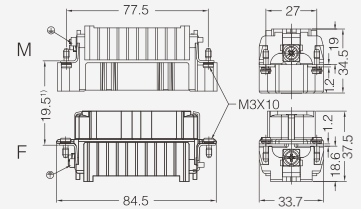

接插针排序

Contacts arrangement view from termination side

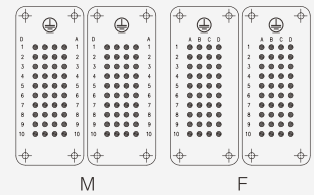

面板安装开孔图

Panel cut out for inserts for use without Hoods/housings

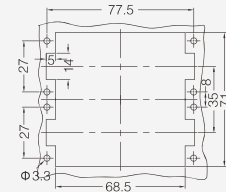

**附件 Accessories**

10A 冷压针 Crimp contacts

接触电阻 Contact resistance  $\leq 3m\Omega$   
镀银 Silver plated



公 Male	订货号 Part Number	母 Female	订货号 Part Number
CDSM-0.37	09150006104	CDSF-0.37	09150006204
CDSM-0.5	09150006103	CDSF-0.5	09150006203
CDSM-0.75	09150006105	CDSF-0.75	09150006205
CDSM-1.0	09150006102	CDSF-1.0	09150006202
CDSM-1.5	09150006101	CDSF-1.5	09150006201
CDSM-2.5	09150006106	CDSF-2.5	09150006206

镀金 Gold plated



公 Male	订货号 Part Number	母 Female	订货号 Part Number
CDGM-0.37	09150006124	CDGF-0.37	09150006224
CDGM-0.5	09150006123	CDGF-0.5	09150006223
CDGM-0.75	09150006125	CDGF-0.75	09150006225
CDGM-1.0	09150006122	CDGF-1.0	09150006222
CDGM-1.5	09150006121	CDGF-1.5	09150006221
CDGM-2.5	09150006126	CDGF-2.5	09150006226

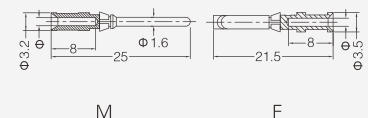

线规 Wire gauge	$\Phi$	剥线长度 Stripping length
0.14-0.37 mm <sup>2</sup>	AWG 26-22	0.9 8 mm
0.5 mm <sup>2</sup>	AWG 20	1.1 8 mm
0.75 mm <sup>2</sup>	AWG 18	1.3 8 mm
1 mm <sup>2</sup>	AWG 18	1.45 8 mm
1.5 mm <sup>2</sup>	AWG 16	1.75 8 mm
2.5 mm <sup>2</sup>	AWG 14	2.25 6 mm

工具 Tools

冷压钳 Crimping tool



压接线经 Wire gauge	型号 Type	订货号 Part Number
0.14-4mm <sup>2</sup>	TL02G	09990000021

退针器 Removal tool



适用类型 For	型号 Type	订货号 Part Number
10A 冷压针	TL00	09990000012
10A Crimp contacts		

更多工具请参考 25-01~25-02页 More tools on P25-01~P25-02



HD-128 超高密度型插芯 Ultra-high Density Inserts 250V 10A 128+

插芯 Inserts

外壳尺寸：匹配48B外壳，详情请参考20-01~20-02页

Hoods/Housings：Matching 48B Hood Housing，detail on P20-01~P20-02

冷压连接 Crimp terminal



插芯 Inserts	型号 Type	订货号 Part Number
公 Male	HD-064-MC(1-64)	09210643001
	HD-064-MC(1-64)	09210643001
母 Female	HD-064-FC(1-64)	09210643101
	HD-064-FC(1-64)	09210643101

1) 接插体之间的最大距离24mm

1) Distance for contact max.24mm

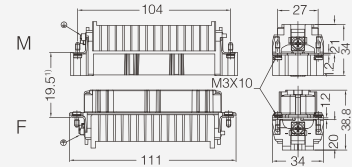

接插针排序

Contacts arrangement view from termination side

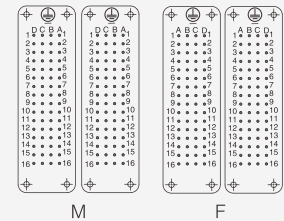

面板安装开孔图

Panel cut out for inserts for use without Hoods/housings

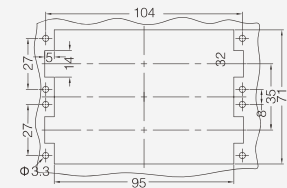

附件 Accessories

10A 冷压针 Crimp contacts

接触电阻 Contact resistance  $\leq 3m\Omega$   
镀银 Silver plated



	公 Male	订货号 Part Number	母 Female	订货号 Part Number
CDSM-0.37		09150006104	CDSF-0.37	09150006204
CDSM-0.5		09150006103	CDSF-0.5	09150006203
CDSM-0.75		09150006105	CDSF-0.75	09150006205
CDSM-1.0		09150006102	CDSF-1.0	09150006202
CDSM-1.5		09150006101	CDSF-1.5	09150006201
CDSM-2.5		09150006106	CDSF-2.5	09150006206

镀金 Gold plated



	公 Male	订货号 Part Number	母 Female	订货号 Part Number
CDGM-0.37		09150006124	CDGF-0.37	09150006224
CDGM-0.5		09150006123	CDGF-0.5	09150006223
CDGM-0.75		09150006125	CDGF-0.75	09150006225
CDGM-1.0		09150006122	CDGF-1.0	09150006222
CDGM-1.5		09150006121	CDGF-1.5	09150006221
CDGM-2.5		09150006126	CDGF-2.5	09150006226

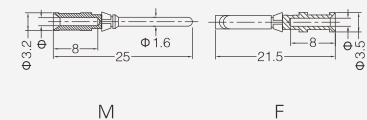

线规 Wire gauge	$\Phi$	剥线长度 Stripping length
0.14-0.37 mm <sup>2</sup>	AWG 26-22	0.9 8 mm
0.5 mm <sup>2</sup>	AWG 20	1.1 8 mm
0.75 mm <sup>2</sup>	AWG 18	1.3 8 mm
1 mm <sup>2</sup>	AWG 18	1.45 8 mm
1.5 mm <sup>2</sup>	AWG 16	1.75 8 mm
2.5 mm <sup>2</sup>	AWG 14	2.25 6 mm

工具 Tools

冷压钳 Crimping tool



压接线经 Wire gauge	型号 Type	订货号 Part Number
0.14-4mm <sup>2</sup>	TL02G	09990000021

退针器 Removal tool



适用类型 For	型号 Type	订货号 Part Number
10A 冷压针 10A Crimp contacts	TL00	09990000012

更多工具请参考 25-01~25-02页 More tools on P25-01~P25-02

## HDD 系列 / HDD SERIES

### 技术参数 Technical Characteristics

规范	Specifications	
规范	Specifications	DIN EN 60 664
		DIN EN 61 984
插芯	Inserts	
依据 EN 61 984的额定电压	Electrical Data Acc. To EN 61 984	
接插件针数	Number Of Contacts	24,42,72,108,144(72X2),216(108X2)+PE
额定电流	Rated Current	10A
额定电压	Rated Voltage	250V
额定脉冲电压	Rated Impulse Voltage	4kV
污染程度	Pollution Degree	3
污染等级2时的参数	Pollution Degree 2 Also	10A 230/400V 4kV 2
依据UL/CSA额定电压	Rated Voltage Acc.to UI CSA	600V
绝缘电阻	Insulation Resistance	$\geq 10^{10} \Omega$
材料	Material	聚碳酸酯 Polycarbonate
工作温度范围	Limiting Temperatures	-40°C...+125°C
依据UL94阻燃等级	Flammability Acc. To UL94	V0
可拔插次数	Mechanical Working Life-mating Cycles	$\geq 500$
插针	Contacts	
材料	Material	铜合金 Copper Alloy
表面处理	Surface	镀金 Hard-gold Plated 镀银 Hard-silver Plated
接触电阻	Contact Resistance	$\leq 3m\Omega$
螺钉连接	Screw Terminal	
导线规格	Wire Gauge	0.14-2.5mm <sup>2</sup>
AWG	AWG	26-14

#### 电流负载能力 Current Carrying Capacity

电流负载能力所受的限制主要来自包含接插针的接插体可承受的最大温度

The current carrying is limited by maximum temperature of materials for Inserts and contacts including terminals.

测试和控制过程依据 Measuring and testing techniques according to DIN EN 60512-5

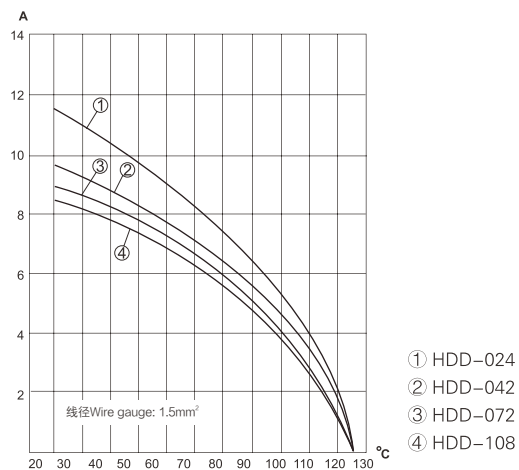
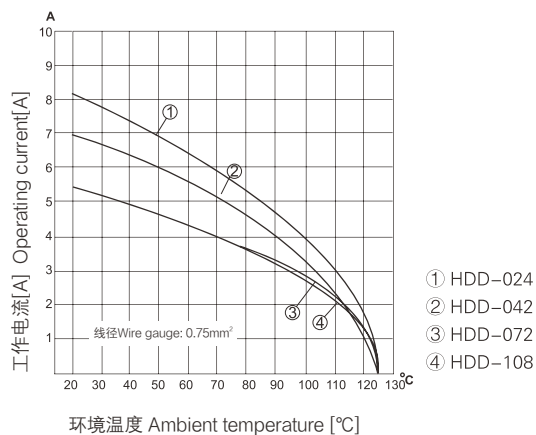



**Global District Limited**

**HDD调整插针分布可提高工作电压至500V / Modified contact arrangement up to 500V**

HD接插体在装满针时,在绝缘等级3(C)时,其工作电压可达到250V。但其插针分布经过调整,同样在绝缘等级3(C)时,其工作电压允许值可达到500V。

The connector series HDD equipped with all contacts may be used for voltages up to 250V ~ pollution degree 3.A modified contact loading arrangement permits use up to 500V ~ pollution degree also in pollution degree C.

**调整后插针分布 Contact arrangement view from termination side**

10A 400V 6kV 3

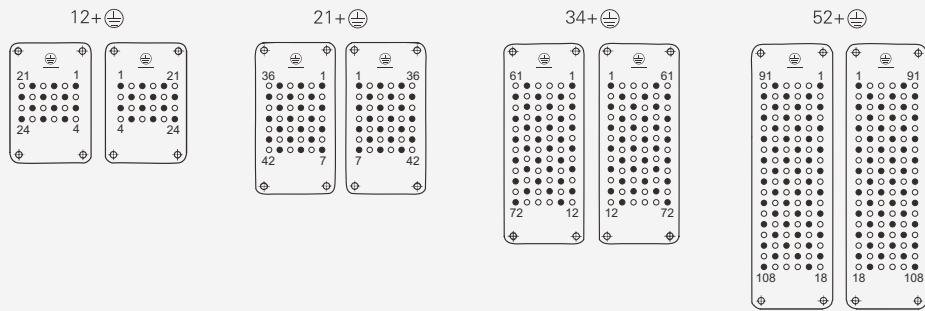

10A 500V 6kV 3

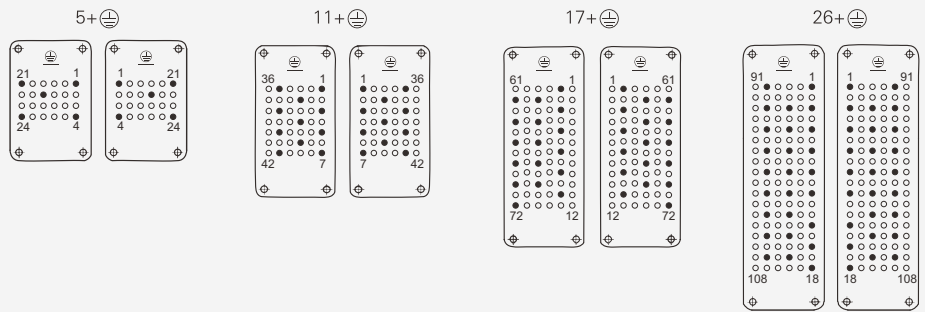

- 装有插针的插孔 Working contact      M 公接插体 Male insert
- 不装有插针的插孔 Without contact      F 母接插体 Female insert



Global District Limited

HDD-024 超高密度型插芯 Ultra-high Density Inserts 250V 10A 24+

**插芯 Inserts**

外壳尺寸：匹配6B外壳，详情请参考15-01~15-10页

Hoods/Housings：Matching 6B Hood Housing，detail on P15-01~P15-10

冷压连接 Crimp terminal



插芯 Inserts	型号 Type	订货号 Part Number
公 Male	HDD-024-MC	09160243001
母 Female	HDD-024-FC	09160243101

1) 接插体之间的最大距离21mm

1) Distance for contact max.21mm

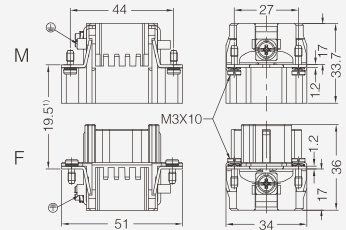

接插针排序

Contacts arrangement view from termination side

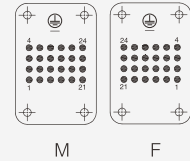

面板安装开孔图

Panel cut out for inserts for use without Hoods/housings

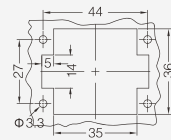

**附件 Accessories**

10A 冷压针 Crimp contacts

接触电阻 Contact resistance  $\leq 3m\Omega$   
镀银 Silver plated



公 Male	订货号 Part Number	母 Female	订货号 Part Number
CDSM-0.37	09150006104	CDSF-0.37	09150006204
CDSM-0.5	09150006103	CDSF-0.5	09150006203
CDSM-0.75	09150006105	CDSF-0.75	09150006205
CDSM-1.0	09150006102	CDSF-1.0	09150006202
CDSM-1.5	09150006101	CDSF-1.5	09150006201
CDSM-2.5	09150006106	CDSF-2.5	09150006206

镀金 Gold plated



公 Male	订货号 Part Number	母 Female	订货号 Part Number
CDGM-0.37	09150006124	CDGF-0.37	09150006224
CDGM-0.5	09150006123	CDGF-0.5	09150006223
CDGM-0.75	09150006125	CDGF-0.75	09150006225
CDGM-1.0	09150006122	CDGF-1.0	09150006222
CDGM-1.5	09150006121	CDGF-1.5	09150006221
CDGM-2.5	09150006126	CDGF-2.5	09150006226

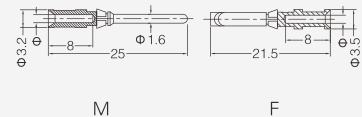

线规 Wire gauge	$\Phi$	剥线长度 Stripping length
0.14-0.37 mm <sup>2</sup>	AWG 26-22	0.9 8 mm
0.5 mm <sup>2</sup>	AWG 20	1.1 8 mm
0.75 mm <sup>2</sup>	AWG 18	1.3 8 mm
1 mm <sup>2</sup>	AWG 18	1.45 8 mm
1.5 mm <sup>2</sup>	AWG 16	1.75 8 mm
2.5 mm <sup>2</sup>	AWG 14	2.25 6 mm

工具 Tools

冷压钳 Crimping tool



压接线经 Wire gauge	型号 Type	订货号 Part Number
0.14-4mm <sup>2</sup>	TL02G	09990000021

退针器 Removal tool



适用类型 For	型号 Type	订货号 Part Number
10A 冷压针 10A Crimp contacts	TL00	09990000012

更多工具请参考 25-01~25-02页 More tools on P25-01~P25-02

**Global District Limited**
**HDD-042 超高密度型插芯 Ultra-high Density Inserts 250V 10A 42+ ⊕**
**插芯 Inserts**

外壳尺寸：匹配10B外壳，详情请参考16-01~16-13页

Hoods/Housings：Matching 10B Hood Housing，detail on P16-01~P16-13

冷压连接 Crimp terminal



插芯 Inserts	型号 Type	订货号 Part Number
公 Male	HDD-042-MC	09160423001
母 Female	HDD-042-FC	09160423101

1) 接插体之间的最大距离21mm

1) Distance for contact max.21mm

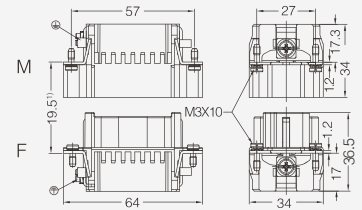
**接插针排序**

Contacts arrangement view from termination side

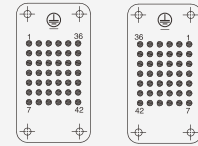

M

F

**面板安装开孔图**

Panel cut out for inserts for use without Hoods/housings

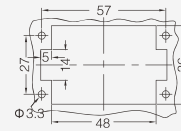
**附件 Accessories**

10A 冷压针 Crimp contacts

 接触电阻 Contact resistance  $\leq 3m\Omega$   
 镀银 Silver plated

公 Male	订货号 Part Number	母 Female	订货号 Part Number
CDSM-0.37	09150006104	CDSF-0.37	09150006204
CDSM-0.5	09150006103	CDSF-0.5	09150006203
CDSM-0.75	09150006105	CDSF-0.75	09150006205
CDSM-1.0	09150006102	CDSF-1.0	09150006202
CDSM-1.5	09150006101	CDSF-1.5	09150006201
CDSM-2.5	09150006106	CDSF-2.5	09150006206

镀金 Gold plated



公 Male	订货号 Part Number	母 Female	订货号 Part Number
CDGM-0.37	09150006124	CDGF-0.37	09150006224
CDGM-0.5	09150006123	CDGF-0.5	09150006223
CDGM-0.75	09150006125	CDGF-0.75	09150006225
CDGM-1.0	09150006122	CDGF-1.0	09150006222
CDGM-1.5	09150006121	CDGF-1.5	09150006221
CDGM-2.5	09150006126	CDGF-2.5	09150006226

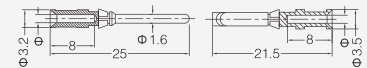

M

F

线规 Wire gauge	$\Phi$	剥线长度 Stripping length
0.14-0.37 mm <sup>2</sup>	AWG 26-22	0.9
0.5 mm <sup>2</sup>	AWG 20	1.1
0.75 mm <sup>2</sup>	AWG 18	1.3
1 mm <sup>2</sup>	AWG 18	1.45
1.5 mm <sup>2</sup>	AWG 16	1.75
2.5 mm <sup>2</sup>	AWG 14	2.25

工具 Tools

冷压钳 Crimping tool



压接线经 Wire gauge	型号 Type	订货号 Part Number
0.14-4mm <sup>2</sup>	TL02G	09990000021

退针器 Removal tool



适用类型 For	型号 Type	订货号 Part Number
10A 冷压针	TL00	09990000012
10A Crimp contacts		

更多工具请参考 25-01~25-02页 More tools on P25-01~P25-02



Global District Limited

HDD-072 超高密度型插芯 Ultra-high Density Inserts 250V 10A 72+

插芯 Inserts

外壳尺寸：匹配16B外壳，详情请参考17-01~17-21页

Hoods/Housings：Matching 16B Hood Housing，detail on P17-01~17-21

冷压连接 Crimp terminal



插芯 Inserts	型号 Type	订货号 Part Number
公 Male	HDD-072-MC	09160723001
母 Female	HDD-072-FC	09160723101

1) 接插体之间的最大距离21mm

1) Distance for contact max.21mm

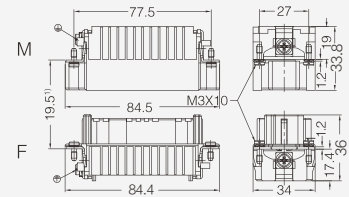

接插针排序

Contacts arrangement view from termination side

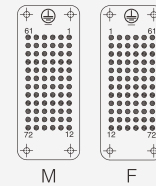

面板安装开孔图

Panel cut out for inserts for use without Hoods/housings

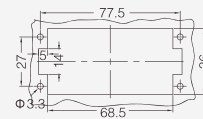

附件 Accessories

10A 冷压针 Crimp contacts

接触电阻 Contact resistance  $\leq 3m\Omega$   
镀银 Silver plated



公 Male	订货号 Part Number	母 Female	订货号 Part Number
CDSM-0.37	09150006104	CDSF-0.37	09150006204
CDSM-0.5	09150006103	CDSF-0.5	09150006203
CDSM-0.75	09150006105	CDSF-0.75	09150006205
CDSM-1.0	09150006102	CDSF-1.0	09150006202
CDSM-1.5	09150006101	CDSF-1.5	09150006201
CDSM-2.5	09150006106	CDSF-2.5	09150006206

镀金 Gold plated



公 Male	订货号 Part Number	母 Female	订货号 Part Number
CDGM-0.37	09150006124	CDGF-0.37	09150006224
CDGM-0.5	09150006123	CDGF-0.5	09150006223
CDGM-0.75	09150006125	CDGF-0.75	09150006225
CDGM-1.0	09150006122	CDGF-1.0	09150006222
CDGM-1.5	09150006121	CDGF-1.5	09150006221
CDGM-2.5	09150006126	CDGF-2.5	09150006226

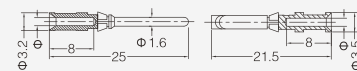

M F

线规 Wire gauge	$\Phi$	剥线长度 Stripping length
0.14-0.37 mm <sup>2</sup>	AWG 26-22	0.9
0.5 mm <sup>2</sup>	AWG 20	1.1
0.75 mm <sup>2</sup>	AWG 18	1.3
1 mm <sup>2</sup>	AWG 18	1.45
1.5 mm <sup>2</sup>	AWG 16	1.75
2.5 mm <sup>2</sup>	AWG 14	2.25

工具 Tools

冷压钳 Crimping tool



压接线经 Wire gauge	型号 Type	订货号 Part Number
0.14-4mm <sup>2</sup>	TL02G	09990000021

退针器 Removal tool



适用类型 For	型号 Type	订货号 Part Number
10A 冷压针 10A Crimp contacts	TL00	09990000012

更多工具请参考 25-01~25-02页 More tools on P25-01~P25-02





Global District Limited

HDD-108 超高密度型插芯 Ultra-high Density Inserts 250V 10A 108+

## 插芯 Inserts

外壳尺寸：匹配24B外壳，详情请参考18-01~18-22页

Hoods/Housings：Matching 24B Hood Housing，detail on P18-01~18-22

## 冷压连接 Crimp terminal



插芯 Inserts	型号 Type	订货号 Part Number
公 Male	HDD-108-MC	09161083001
母 Female	HDD-108-FC	09161083101

1) 接插体之间的最大距离24mm

1) Distance for contact max.24mm

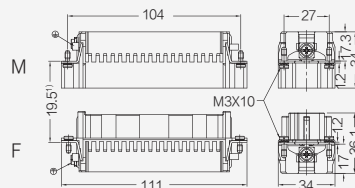

## 接插针排序

Contacts arrangement view from termination side

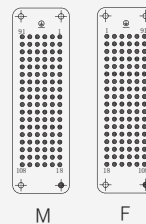

## 面板安装开孔图

Panel cut out for inserts for use without Hoods/housings

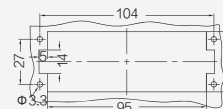

## 附件 Accessories

## 10A 冷压针 Crimp contacts

接触电阻 Contact resistance  $\leq 3m\Omega$   
镀银 Silver plated

公 Male	订货号 Part Number	母 Female	订货号 Part Number
CDSM-0.37	09150006104	CDSF-0.37	09150006204
CDSM-0.5	09150006103	CDSF-0.5	09150006203
CDSM-0.75	09150006105	CDSF-0.75	09150006205
CDSM-1.0	09150006102	CDSF-1.0	09150006202
CDSM-1.5	09150006101	CDSF-1.5	09150006201
CDSM-2.5	09150006106	CDSF-2.5	09150006206

镀金 Gold plated



公 Male	订货号 Part Number	母 Female	订货号 Part Number
CDGM-0.37	09150006124	CDGF-0.37	09150006224
CDGM-0.5	09150006123	CDGF-0.5	09150006223
CDGM-0.75	09150006125	CDGF-0.75	09150006225
CDGM-1.0	09150006122	CDGF-1.0	09150006222
CDGM-1.5	09150006121	CDGF-1.5	09150006221
CDGM-2.5	09150006126	CDGF-2.5	09150006226

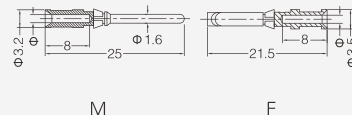

线规 Wire gauge	$\Phi$	剥线长度 Stripping length
0.14-0.37 mm <sup>2</sup>	AWG 26-22	0.9
0.5 mm <sup>2</sup>	AWG 20	1.1
0.75 mm <sup>2</sup>	AWG 18	1.3
1 mm <sup>2</sup>	AWG 18	1.45
1.5 mm <sup>2</sup>	AWG 16	1.75
2.5 mm <sup>2</sup>	AWG 14	2.25

## 工具 Tools

## 冷压钳 Crimping tool



压接线经 Wire gauge	型号 Type	订货号 Part Number
0.14-4mm <sup>2</sup>	TL02G	09990000021

## 退针器 Removal tool



适用类型 For	型号 Type	订货号 Part Number
10A 冷压针	TL00	09990000012
10A Crimp contacts		

更多工具请参考 25-01~25-02页 More tools on P25-01~P25-02



HDD-144 超高密度型插芯 Ultra-high Density Inserts 250V 10A 144+

插芯 Inserts

外壳尺寸：匹配32B外壳，详情请参考19-01~19-04页

Hoods/Housings：Matching 32B Hood Housing，detail on P19-01~19-04

冷压连接 Crimp terminal



插芯 Inserts	型号 Type	订货号 Part Number
公 Male	HDD-072-MC(1-72)	09160723001
	HDD-072-MC(73-144)	09160723011
母 Female	HDD-072-FC(1-72)	09160723101
	HDD-072-FC(73-144)	09160723111

1) 接插体之间的最大距离21mm  
1) Distance for contact max.21mm

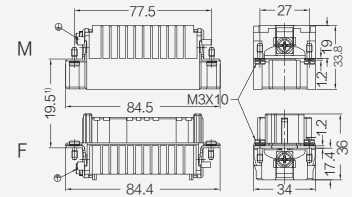

接插针排序

Contacts arrangement view from termination side

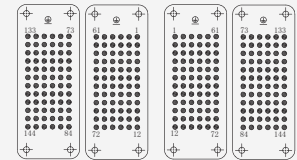

M

F

面板安装开孔图

Panel cut out for inserts for use without Hoods/housings

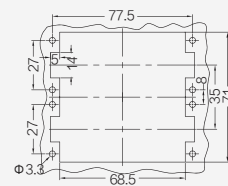

附件 Accessories

10A 冷压针 Crimp contacts

接触电阻 Contact resistance  $\leq 3m\Omega$   
镀银 Silver plated



公 Male	订货号 Part Number	母 Female	订货号 Part Number
CDSM-0.37	09150006104	CDSF-0.37	09150006204
CDSM-0.5	09150006103	CDSF-0.5	09150006203
CDSM-0.75	09150006105	CDSF-0.75	09150006205
CDSM-1.0	09150006102	CDSF-1.0	09150006202
CDSM-1.5	09150006101	CDSF-1.5	09150006201
CDSM-2.5	09150006106	CDSF-2.5	09150006206

镀金 Gold plated



公 Male	订货号 Part Number	母 Female	订货号 Part Number
CDGM-0.37	09150006124	CDGF-0.37	09150006224
CDGM-0.5	09150006123	CDGF-0.5	09150006223
CDGM-0.75	09150006125	CDGF-0.75	09150006225
CDGM-1.0	09150006122	CDGF-1.0	09150006222
CDGM-1.5	09150006121	CDGF-1.5	09150006221
CDGM-2.5	09150006126	CDGF-2.5	09150006226

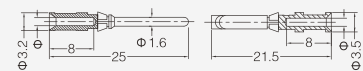

M

F

线规 Wire gauge	$\Phi$	剥线长度 Stripping length
0.14-0.37 mm <sup>2</sup>	AWG 26-22	0.9
0.5 mm <sup>2</sup>	AWG 20	1.1
0.75 mm <sup>2</sup>	AWG 18	1.3
1 mm <sup>2</sup>	AWG 18	1.45
1.5 mm <sup>2</sup>	AWG 16	1.75
2.5 mm <sup>2</sup>	AWG 14	2.25

工具 Tools

冷压钳 Crimping tool



压接线经 Wire gauge	型号 Type	订货号 Part Number
0.14-4mm <sup>2</sup>	TL02G	09990000021

退针器 Removal tool



适用类型 For	型号 Type	订货号 Part Number
10A 冷压针 10A Crimp contacts	TL00	09990000012

更多工具请参考 25-01~25-02页 More tools on P25-01~P25-02



**Global District Limited**

HDD-216 超高密度型插芯 Ultra-high Density Inserts 250V 10A 108+

**插芯 Inserts**

外壳尺寸：匹配48B外壳，详情请参考20-01~20-02页

Hoods/Housings : Matching 48B Hood Housing , detail on P20-01~20-02

冷压连接 Crimp terminal



插芯 Inserts	型号 Type	订货号 Part Number
公 Male	HDD-108-MC(1-108)	09161083001
	HDD-108-MC(109-216)	09161083011
母 Female	HDD-108-FC(1-108)	09161083101
	HDD-108-FC(109-216)	09161083111

1) 接插体之间的最大距离21mm

1) Distance for contact max.21mm

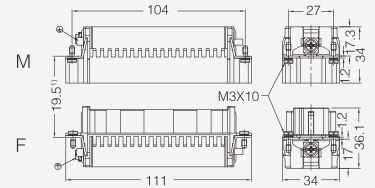

接插针排序

Contacts arrangement view from termination side

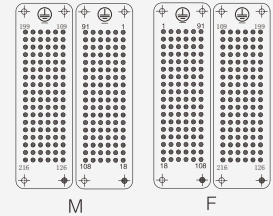

面板安装开孔图

Panel cut out for inserts for use without Hoods/housings

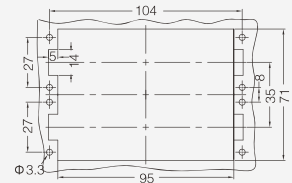

**附件 Accessories**

10A 冷压针 Crimp contacts

接触电阻 Contact resistance  $\leq 3m\Omega$   
镀银 Silver plated



公 Male	订货号 Part Number	母 Female	订货号 Part Number
CDSM-0.37	09150006104	CDSF-0.37	09150006204
CDSM-0.5	09150006103	CDSF-0.5	09150006203
CDSM-0.75	09150006105	CDSF-0.75	09150006205
CDSM-1.0	09150006102	CDSF-1.0	09150006202
CDSM-1.5	09150006101	CDSF-1.5	09150006201
CDSM-2.5	09150006106	CDSF-2.5	09150006206

镀金 Gold plated



公 Male	订货号 Part Number	母 Female	订货号 Part Number
CDGM-0.37	09150006124	CDGF-0.37	09150006224
CDGM-0.5	09150006123	CDGF-0.5	09150006223
CDGM-0.75	09150006125	CDGF-0.75	09150006225
CDGM-1.0	09150006122	CDGF-1.0	09150006222
CDGM-1.5	09150006121	CDGF-1.5	09150006221
CDGM-2.5	09150006126	CDGF-2.5	09150006226

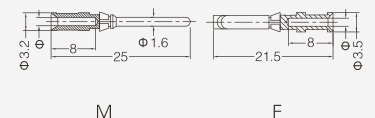

线规 Wire gauge	$\Phi$	剥线长度 Stripping length
0.14-0.37 mm <sup>2</sup>	AWG 26-22	0.9 8 mm
0.5 mm <sup>2</sup>	AWG 20	1.1 8 mm
0.75 mm <sup>2</sup>	AWG 18	1.3 8 mm
1 mm <sup>2</sup>	AWG 18	1.45 8 mm
1.5 mm <sup>2</sup>	AWG 16	1.75 8 mm
2.5 mm <sup>2</sup>	AWG 14	2.25 6 mm

工具 Tools

冷压钳 Crimping tool



压接线径 Wire gauge	型号 Type	订货号 Part Number
0.14-4mm <sup>2</sup>	TL02G	09990000021

退针器 Removal tool



适用类型 For	型号 Type	订货号 Part Number
10A 冷压针	TL00	09990000012
10A Crimp contacts		

更多工具请参考 25-01~25-02页 More tools on P25-01~P25-02



## HSB 系列 / HSB SERIES

## 技术参数 Technical Characteristics

规范	Specifications	
规范	Specifications	DIN EN 60 664
		DIN EN 61 984
插芯	Inserts	
依据 EN 61 984的额定电压	Electrical data acc. to EN 61 984	
接插件针数	Number Of Contacts	4,6,12+PE
额定电流	Rated Current	35A
相对地额定电压	Rated Voltage	400V
相间额定电压		690V
额定脉冲电压	Rated Impulse Voltage	6kV
污染程度	Pollution Degree	3
或	Or	35A 500V 6kV 3
依据UL/CSA额定电压	Rated Voltage Acc.to UI CSA	600V
绝缘电阻	Insulation Resistance	$\geq 10^{10} \Omega$
材料	Material	聚碳酸酯 Polycarbonate
工作温度范围	Limiting Temperatures	-40°C...+125°C
依据UL94阻燃等级	Flammability Acc. To UL94	V0
可拔插次数	Mechanical Working Life-mating Cycles	$\geq 500$
插针	Contacts	
材料	Material	铜合金 Copper Alloy
表面处理	Surface	镀银 Hard-silver Plated
接触电阻	Contact Resistance	$\leq 1m\Omega$
螺钉连接	Screw Terminal	
导线规格	Wire Gauge	1.5-6mm <sup>2</sup>
AWG	AWG	10
拧紧力矩	Tightening Torque	1.2Nm

## 电流负载能力 Current Carrying Capacity

电流负载能力所受的限制主要来自包含接插针的接插体可承受的最大温度

The current carrying is limited by maximum temperature of materials for Inserts and contacts including terminals.

测试和控制过程依据 Measuring and testing techniques according to DIN EN 60512-5

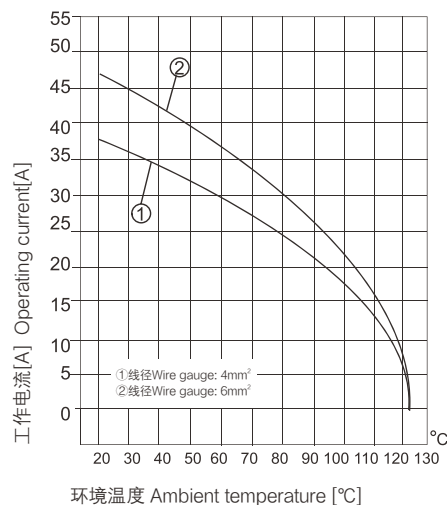



Global District Limited

HSBS-004 大电流型插芯 Heavy-current Inserts 400V/690V 35A 4+

插芯 Inserts

外壳尺寸：匹配6B外壳，详情请参考15-01-15-10页

Hoods/Housings：Matching 6B Hood Housing，detail on P15-01-15-10

螺丝连接 Screw terminal



插芯 Inserts	型号 Type	订货号 Part Number
公 Male	HSBS-004-M	09410042601
母 Female	HSBS-004-F	09410042701

1) 接插体之间的最大距离21mm  
1) Distance for contact max.21mm

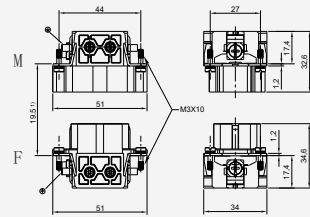

接插针排序  
Contacts arrangement view from termination side

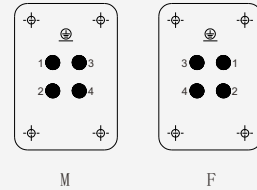

面板安装开孔图  
Panel cut out for inserts for use without Hoods/housings

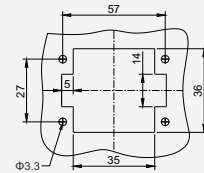



**Global District Limited**

HSB-004 大电流型插芯 Heavy-current Inserts 400V/690V 35A 4+

**插芯 Inserts**

外壳尺寸：匹配10B外壳，详情请参考16-01~16-13页

Hoods/Housings : Matching 10B Hood Housing , detail on P16-01~16-13

螺丝连接 Screw terminal



插芯 Inserts	型号 Type	订货号 Part Number
公 Male	HSB-004-M	09310042601
母 Female	HSB-004-F	09310042701

1) 接插体之间的最大距离21mm

1) Distance for contact max.21mm

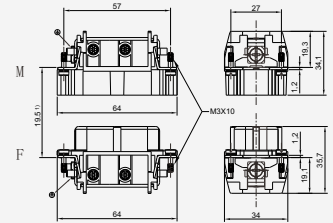

接插针排序

Contacts arrangement view from termination side

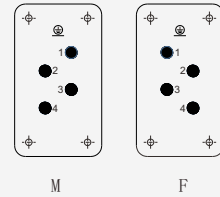

面板安装开孔图

Panel cut out for inserts for use without Hoods/housings

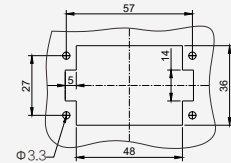



**Global District Limited**

HSB-006 大电流型插芯 Heavy-current Inserts 400V/690V 35A 6+

**插芯 Inserts**

外壳尺寸：匹配16B外壳，详情请参考17-01~17-21页

Hoods/Housings：Matching 16B Hood Housing，detail on P17-01~17-21

螺丝连接 Screw terminal



插芯 Inserts	型号 Type	订货号 Part Number
公 Male	HSB-006-M	09310062601
母 Female	HSB-006-F	09310062701

1) 接插体之间的最大距离21mm  
1) Distance for contact max.21mm

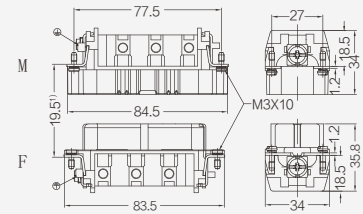

**接插针排序**

Contacts arrangement view from termination side

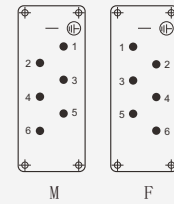

**面板安装开孔图**

Panel cut out for inserts for use without Hoods/housings

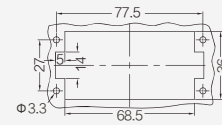



**Global District Limited**

HSB-012 大电流型插芯 Heavy-current Inserts 400V/690V 35A 12+

**插芯 Inserts**

外壳尺寸：匹配32B外壳，详情请参考19-01-19-04页

Hoods/Housings : Matching 32B Hood Housing , detail on P19-01-19-04

螺丝连接 Screw terminal



插芯 Inserts	型号 Type	订货号 Part Number
公 Male	HSB-006-M(1-6)	09310062601
	HSB-006-M(7-12)	09310062611
母 Female	HSB-006-F(1-6)	09310062701
	HSB-006-F(7-12)	09310062711

1) 接插体之间的最大距离21mm

1) Distance for contact max.21mm

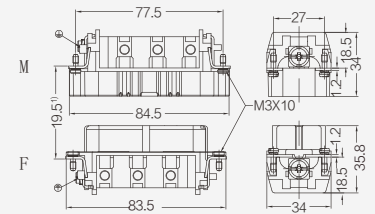

**接插针排序**

Contacts arrangement view from termination side

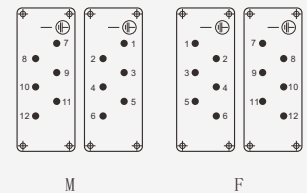

**面板安装开孔图**

Panel cut out for use without Hoods/housings

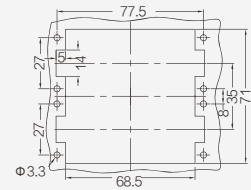





## HK-008/24 组合型插芯 Combination inserts

## 技术参数 Technical Characteristics

规范	Specifications	
规范	Specifications	DIN EN 60 664
		DIN EN 61 984
插芯	Inserts	
接插件针数	Number Of Contacts	8/24+PE
依据 EN 61 984的额定电压	Electrical Data Acc. To EN 61 984	
电力区	Power Area	
-额定电流	-Rated Current	16A
-额定电压	-Rated Voltage	230/400V
-额定脉冲电压	-Rated Impulse Voltage	4kV
-污染程度	-Pollution Degree	3
-当污染程度2时的参数	-Pollution Degree 2 Also	10A 250V 4kV 2
信号区	Signal Area	
-额定电流	-Rated Current	10A
-额定电压	-Rated Voltage	160V
-额定脉冲电压	-Rated Impulse Voltage	2.5kV
-污染程度	-Pollution Degree	3
依据UL/CSA额定电压	Rated Voltage Acc.to UI CSA	600/300V
绝缘电阻	Insulation Resistance	$\geq 10^{10}\Omega$
材料	Material	聚碳酸酯 Polycarbonate
工作温度范围	Limiting Temperatures	-40°C...+125°C
阻燃等级	Flammability Acc. To UI94	V0
可拔插次数	Mechanical Working Life-mating Cycles	$\geq 500$
插针	Contacts	
强电针	Power Contacts	
-材料	-Material	铜合金 Copper Alloy
-表面处理	-Surface	镀金 Hard-gold Plated
		镀银 Hard-silver Plated
-接触电阻	-Contact Resistance	$\leq 1m\Omega$
-冷压连接	-Crimp Terminal	
- mm <sup>2</sup>	-mm <sup>2</sup>	0.5-4mm <sup>2</sup>
- AWG	-AWG	20-12
信号针	Signal Contacts	
-材料	-Material	铜合金 Copper Alloy
-表面处理	-Surface	镀金 Hard-gold Plated
		镀银 Hard-silver Plated
-接触电阻	-Contact Resistance	$\leq 3m\Omega$
-冷压连接	-Crimp Terminal	
- mm <sup>2</sup>	-mm <sup>2</sup>	0.14-2.5mm <sup>2</sup>
- AWG	-AWG	25-14

## 电流负载能力 Current Carrying Capacity

电流负载能力所受的限制主要来自包含接插针的接插体可承受的最大温度

The current carrying is limited by maximum temperature of materials for Inserts and contacts including terminals.

测试和控制过程依据 Measuring and testing techniques according to DIN EN 60512-5

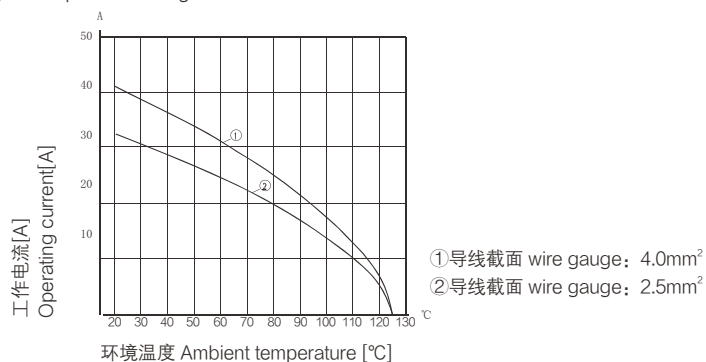



HK-008/24 组合型插芯 Combination inserts 400/160V 16/10A 8/24+Ⓢ

插芯 Inserts

外壳尺寸：匹配10B外壳，详情请参考16-01~16-13页

Hoods/Housings : Matching 10B Hood Housing , detail on P16-01~P16-13

冷压连接 Crimp Terminal



插芯 Inserts	型号 Type	订货号 Part Number
公 Male	HK-008/24-MC	09380323001
母 Female	HK-008/24-FC	09380323101

接插体之间的最大距离21mm

Distance for contact max.21mm

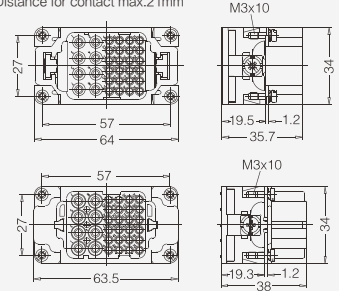

接插针排序

Contacts arrangement view from termination side

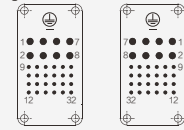

M

F

附件 Accessories

10A 冷压针 Crimp contacts

接触电阻 Contact resistance  $\leq 3m\Omega$   
镀银 Silver plated



公 Male	订货号 Part Number	母 Female	订货号 Part Number
CDSM-0.37	09150006104	CDSM-0.37	09150006204
CDSM-0.5	09150006103	CDSM-0.5	09150006203
CDSM-0.75	09150006105	CDSM-0.75	09150006205
CDSM-1.0	09150006102	CDSM-1.0	09150006202
CDSM-1.5	09150006101	CDSM-1.5	09150006201
CDSM-2.5	09150006106	CDSM-2.5	09150006206

镀金 Gold plated



公 Male	订货号 Part Number	母 Female	订货号 Part Number
CDGM-0.37	09150006124	CDGM-0.37	09150006224
CDGM-0.5	09150006123	CDGM-0.5	09150006223
CDGM-0.75	09150006125	CDGM-0.75	09150006225
CDGM-1.0	09150006122	CDGM-1.0	09150006222
CDGM-1.5	09150006121	CDGM-1.5	09150006221
CDGM-2.5	09150006126	CDGM-2.5	09150006226

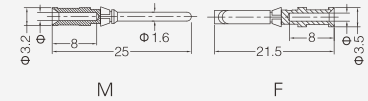

M

F

线规 Wire gauge	$\Phi$	剥线长度 Stripping length
0.14-0.37 mm <sup>2</sup> AWG 26-22	0.9	8 mm
0.5 mm <sup>2</sup> AWG 20	1.1	8 mm
0.75 mm <sup>2</sup> AWG 18	1.3	8 mm
1 mm <sup>2</sup> AWG 18	1.45	8 mm
1.5 mm <sup>2</sup> AWG 16	1.75	8 mm
2.5 mm <sup>2</sup> AWG 14	2.25	6 mm

16A 冷压针 Crimp contacts

接触电阻 Contact resistance  $\leq 1m\Omega$   
镀银 Silver plated



公 Male	订货号 Part Number	母 Female	订货号 Part Number
CESM-0.37	09330006127	CESF-0.37	09330006227
CESM-0.5	09330006121	CESF-0.5	09330006220
CESM-0.75	09330006114	CESF-0.75	09330006214
CESM-1.0	09330006105	CESF-1.0	09330006205
CESM-1.5	09330006104	CESF-1.5	09330006204
CESM-2.5	09330006102	CESF-2.5	09330006202
CESM-3.0	09330006106	CESF-3.0	09330006206
CESM-4.0	09330006107	CESF-4.0	09330006207

镀金 Gold plated



公 Male	订货号 Part Number	母 Female	订货号 Part Number
CEGM-0.37	09330006117	CEGF-0.37	09330006217
CEGM-0.5	09330006122	CEGF-0.5	09330006222
CEGM-0.75	09330006115	CEGF-0.75	09330006215
CEGM-1.0	09330006118	CEGF-1.0	09330006218
CEGM-1.5	09330006116	CEGF-1.5	09330006216
CEGM-2.5	09330006123	CEGF-2.5	09330006223
CEGM-4.0	09330006119	CEGF-4.0	09330006221

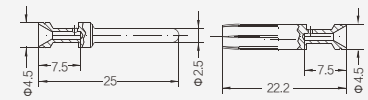

M

F

标示 Identification	线规 Wire gauge	剥线长度 Stripping length
no groove	0.14-0.37mm <sup>2</sup> AWG 26-22	7.5mm
no groove	0.5mm <sup>2</sup> AWG 20	7.5mm
1 groove	0.75mm <sup>2</sup> AWG 18	7.5mm
1 groove	1mm <sup>2</sup> AWG 18	7.5mm
2 groove	1.5mm <sup>2</sup> AWG 16	7.5mm
3 groove	2.5mm <sup>2</sup> AWG 14	7.5mm
wide groove	3mm <sup>2</sup> AWG 12	7.5mm
no groove	4mm <sup>2</sup> AWG 12	7.5mm

工具 Tools

冷压钳 Crimping tool



压接线经 Wire gauge	型号 Type	订货号 Part Number
0.14-4mm <sup>2</sup>	TL02G	09990000021

退针器 Removal tool



适用类型 For	型号 Type	订货号 Part Number
10A 冷压针 Crimp contacts	T100	09990000012

更多工具请参考 25-01~25-02页 More tools on P25-01~P25-02



## HK-004/4 组合型插芯 Combination inserts

## 技术参数 Technical Characteristics

规范	Specifications	DIN EN 60 664
规范	Specifications	DIN EN 61 984
插芯	Inserts	
接插件针数	Number Of Contacts	4/4+PE
依据 DIN 61984的电气数据	Electrical Data Acc. To EN 61 984	
电力区	Power Area	
-额定电流	-Rated Current	70A
-额定电压	-Rated Voltage	690V
-额定脉冲电压	-Rated Impulse Voltage	8kV
-污染程度	-Pollution Degree	3
信号区	Signal Area	
-额定电流	-Rated Current	16A
-额定电压	-Rated Voltage	250V
-额定脉冲电压	-Rated Impulse Voltage	4kV
-污染程度	-Pollution Degree	3
依据UL/CSA额定电压	Rated Voltage Acc.to UI CSA	600V/230V
绝缘电阻	Insulation Resistance	$\geq 10^{10} \Omega$
材料	Material	聚碳酸酯 Polycarbonate
工作温度范围	Limiting Temperatures	-40°C...+125°C
阻燃等级(UL94)	Flammability Acc. To UI94	V0
可拔插次数	Mechanical Working Life-mating Cycles	$\geq 500$
插针	Contacts	
电力区	Power Area	
材料	Material	铜合金 Copper Alloy
-表面处理	Surface treatment	镀银 Hard-silver Plated
-接触电阻	Contact Resistance	$\leq 0.5m\Omega$
-冷压连接	Crimp Terminal	
-mm <sup>2</sup>	-mm <sup>2</sup>	10-25mm <sup>2</sup>
-AWG	-AWG	8-4
最大电缆直径	-Max.insulation diameter	11mm
-剥线长度	Wire stripping length	15.5mm
信号区	Signal Area	
-材料	Surface	铜合金 Copper Alloy
-表面处理	Surface treatment	镀银 Hard-silver Plated
-接触电阻	Contact Resistance	$\leq 1m\Omega$
-冷压连接	Crimp Terminal	
-mm <sup>2</sup>	-mm <sup>2</sup>	0.14-4mm <sup>2</sup>
-AWG	-AWG	26-12

## 电流负载能力 Current Carrying Capacity

电流负载能力所受的限制主要来自包含接插针的接插体可承受的最大温度

The current carrying is limited by maximum temperature of materials for Inserts and contacts including terminals.

测试和控制过程依据 Measuring and testing techniques according to DIN EN 60512-5

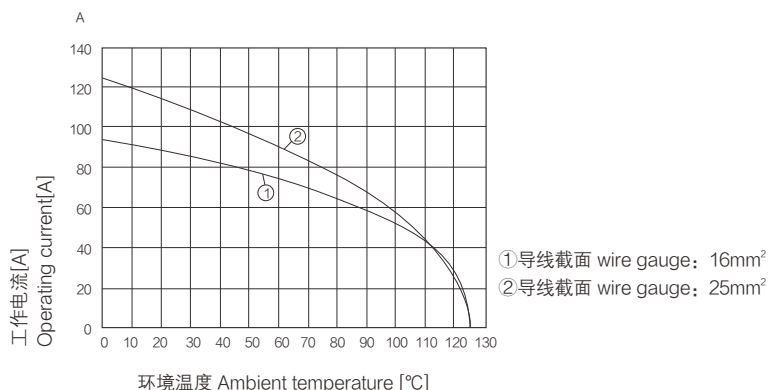



HK-004/4 组合型插芯 Combination inserts 690/250V 70/16A 4/4+

插芯 Inserts

外壳尺寸：匹配10B外壳，详情请参考16-01~16-13页

Hoods/Housings : Matching 10B Hood Housing , detail on P16-01~P16-13

冷压连接 Crimp Terminal



插芯 Inserts	型号 Type	订货号 Part Number
公 Male	HK-004.1/4-M(6-16mm <sup>2</sup> )	09380082601
	HK-004.2/4-M(10-22mm <sup>2</sup> )	09380082701
母 Female	HK-004.1/4-F(6-16mm <sup>2</sup> )	09380082602
	HK-004.2/4-F(10-22mm <sup>2</sup> )	09380082702

接插体之间的最大距离21mm  
Distance for contact max.21mm

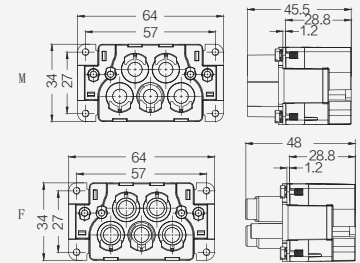

接插针排序  
Contacts arrangement view from termination side

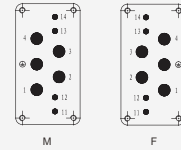



## HK-004/0,004/2 组合型插芯 Combination inserts

## 技术参数 Technical Characteristics

规范	Specifications	DIN EN 60 664
规范	Specifications	DIN EN 61 984
插芯	Inserts	
接插件针数	Number Of Contacts	4/0, 4/2+PE
依据 EN 61 984的额定电压	Electrical Data Acc. To EN 61 984	
电力区	Power Area	
-额定电流	-Rated Current	80A
-额定电压	-Rated Voltage	830V
-额定脉冲电压	-Rated Impulse Voltage	8kV
-污染程度	-Pollution Degree	3
-当污染程度2时的参数	-Pollution Degree 2 Also	80A 1000V 8kV 2
信号区	Signal Area	
-额定电流	-Rated Current	16A
-额定电压	-Rated Voltage	400V
-额定脉冲电压	-Rated Impulse Voltage	6kV
-污染程度	-Pollution Degree	3
-当污染程度2时的参数	-Pollution Degree 2 Also	16A 400/690V 6kV 2
依据UL/CSA额定电压	Rated Voltage Acc.to UI CSA	600/300V
绝缘电阻	Insulation Resistance	$\geq 10^{10} \Omega$
材料	Material	聚碳酸酯 Polycarbonate
工作温度范围	Limiting Temperatures	-40°C...+125°C
阻燃等级(UL94)	Flammability Acc. To UI94	V0
可拔插次数	MecHKnical Working Life-mating Cycles	$\geq 500$
插针	Contacts	
电力区	Power Area	
-材料	-Material	铜合金 Copper Alloy
-表面处理	-Surface	镀银 Hard-silver Plated
-接触电阻	-Contact Resistance	$\leq 0.3m\Omega$
-螺钉连接	-Screw Terminal	
- mm <sup>2</sup>	-mm <sup>2</sup>	1.5-16mm <sup>2</sup>
- AWG	-AWG	16-6
-拧紧力矩	-Tightening Torque	
- mm <sup>2</sup>	- mm <sup>2</sup>	1.5 2.5 4 6 10 16
- N.m	- N.m	1.2 2 3 3 3 3
-剥线长度	-Stripping length	14mm
信号区	Signal Area	
-材料	-Material	铜合金 Copper Alloy
-表面处理	-Surface	镀银 Hard-silver Plated
-接触电阻	-Contact Resistance	$\leq 1m\Omega$
-螺钉连接	-Screw Terminal	
- mm <sup>2</sup>	-mm <sup>2</sup>	0.5-2.5mm <sup>2</sup>
- AWG	-AWG	20-14
-拧紧力矩	-Tightening Torque	0.5Nm
-剥线长度	-Stripping length	7.5mm

## 电流负载能力 Current Carrying Capacity

电流负载能力所受的限制主要来自包含接插针的接插体可承受的最大温度

The current carrying is limited by maximum temperature of materials for Inserts and contacts including terminals.

测试和控制过程依据 Measuring and testing techniques according to DIN EN 60512-5

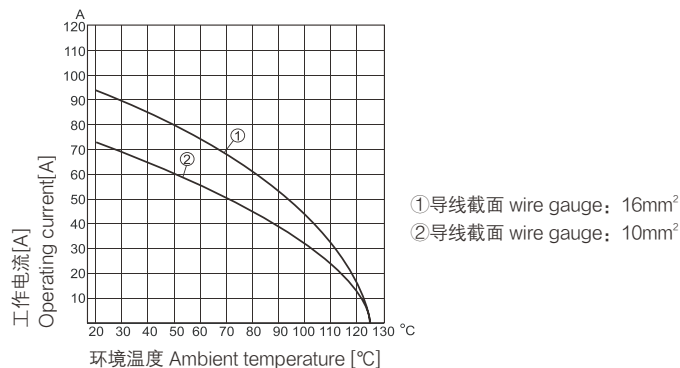



**Global District Limited**

HK-004/0,004/2 组合型插芯 Combination inserts 830/400V 80/16A 4/0, 4/2+ ⊕

**插芯 Inserts**

外壳尺寸：匹配16B外壳，详情请参考17-01~17-21页

Hoods/Housings：Matching 16B Hood Housing，detail on P17-01~17-21

螺丝连接 Screw terminal



插芯 Inserts	型号 Type	订货号 Part Number
公 Male	HK-004/0-M	09380062611
母 Female	HK-004/0-F	09380062711



插芯 Inserts	型号 Type	订货号 Part Number
公 Male	HK-004/2-M	09380062601
母 Female	HK-004/2-F	09380062701

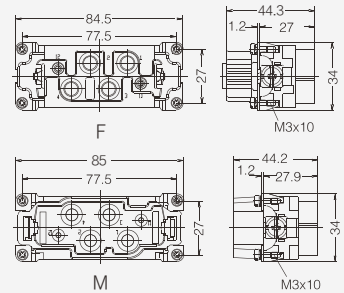

接插针排序  
Contacts arrangement view from termination side

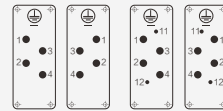



## HWK-006/6 组合型插芯 Combination inserts

## 技术参数 Technical Characteristics

规范	Specifications	DIN EN 60 664
规范	Specifications	DIN EN 61 984
插芯	Inserts	
接插件针数	Number Of Contacts	6/6+PE
依据 EN 61 984的额定电压	Electrical Data Acc. To EN 61 984	
电力区	Power Area	
-额定电流	-Rated Current	40A
-额定电压	-Rated Voltage	400/690V
-额定脉冲电压	-Rated Impulse Voltage	6kV
-污染程度	-Pollution Degree	3
信号区	Signal Area	
-额定电流	-Rated Current	16A
-额定电压	-Rated Voltage	230/400V
-额定脉冲电压	-Rated Impulse Voltage	4kV
-污染程度	-Pollution Degree	3
依据UL/CSA额定电压	Rated Voltage Acc.to UI CSA	600/600V
绝缘电阻	Insulation Resistance	$\geq 10^{10} \Omega$
材料	Material	聚碳酸酯 Polycarbonate
工作温度范围	Limiting Temperatures	-40°C...+125°C
阻燃等级(UL94)	Flammability Acc. To UI94	V0
可拔插次数	Mechanical Working Life-mating Cycles	$\geq 500$
插针	Contacts	
材料	Material	铜合金 Copper Alloy
表面处理	Surface	镀银 Hard-silver Plated
接线形式	Terminal	螺丝连接 Screw Terminal
接触电阻	Contact Resistance	
-电力区	Power Area	$\leq 0.3m\Omega$
-信号区	Signal Area	$\leq 1m\Omega$
导线规格	Wire gauge	
-电力区	Power Area	
-mm <sup>2</sup>	-mm <sup>2</sup>	4-10mm <sup>2</sup>
-AWG	-AWG	12-8
-信号区	Signal Area	
-mm <sup>2</sup>	-mm <sup>2</sup>	1-2.5mm <sup>2</sup>
-AWG	-AWG	18-4
拧紧力矩	Tightening Torque	
-电力区	Power Area	mm <sup>2</sup> 1.5 2.5 4 6 10 16 N.m 1.2 2 3 3 3 3
-信号区	Signal Area	0.5N.m

## 电流负载能力 Current Carrying Capacity

电流负载能力所受的限制主要来自包含接插针的接插体可承受的最大温度

The current carrying is limited by maximum temperature of materials for Inserts and contacts including terminals.

测试和控制过程依据 Measuring and testing techniques according to DIN EN 60512-5

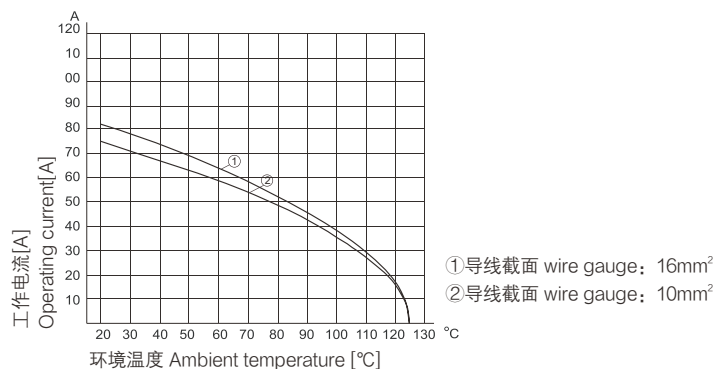



Global District Limited

HWK-006/6 组合型插芯 Combination inserts 690/400V 40/16A 6/6+ ⊕

插芯 Inserts

外壳尺寸：匹配16B外壳，详情请参考17-01~17-21页

Hoods/Housings：Matching 16B Hood Housing，detail on P17-01~17-21

螺丝连接 Screw terminal



插芯 Inserts	型号 Type	订货号 Part Number
公 Male	HWK-006/6-M	09380122801
母 Female	HWK-006/6-F	09380122901

接插体之间的最大距离21mm

Distance for contact max.21mm

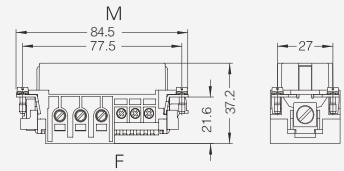
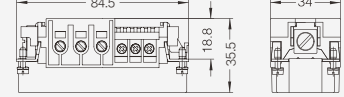

接插针排序

Contacts arrangement view from termination side

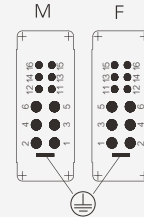



**HK-006/12 组合型插芯 Combination inserts**
**技术参数 Technical Characteristics**

规范	Specifications	DIN EN 60 664
规范	Specifications	DIN EN 61 984
插芯	Inserts	
接插件针数	Number Of Contacts	6/12+PE
依据 EN 61 984的额定电压	Electrical Data Acc. To EN 61 984	
电力区	Power Area	
-额定电流	-Rated Current	40A
-额定电压	-Rated Voltage	690V
-额定脉冲电压	-Rated Impulse Voltage	6kV
-污染程度	-Pollution Degree	3
信号区	Signal Area	
-额定电流	-Rated Current	10A
-额定电压	-Rated Voltage	230/400V
-额定脉冲电压	-Rated Impulse Voltage	4kV
-污染程度	-Pollution Degree	3
依据UL/CSA额定电压	Rated Voltage Acc.to UI CSA	600/300V
绝缘电阻	Insulation Resistance	$\geq 10^{10} \Omega$
材料	Material	聚碳酸酯 Polycarbonate
工作温度范围	Limiting Temperatures	-40°C...+125°C
阻燃等级(UL94)	Flammability Acc. To UI94	V0
可拔插次数	Mechanical Working Life-mating Cycles	$\geq 500$
插针	Contacts	
强电针	Power Contacts	
-材料	-Material	铜合金 Copper Alloy
-表面处理	-Surface	镀银 Hard-silver Plated
-接触电阻	-Contact Resistance	$\leq 0.5m\Omega$
-轴向螺钉连接	-Axial Screw Terminal	
- mm <sup>2</sup>	-mm <sup>2</sup>	2.5-10mm <sup>2</sup>
- AWG	-AWG	14-8
-最大绝缘直径	-Max. Insulation Diameter	6.1mm
-拧紧力矩	-Tightening Torque	
- mm <sup>2</sup>	- mm <sup>2</sup>	2.5 4 6 10
- N.m	- N.m	1.5 1.5 2 2
-剥线长度	-Stripping length	
- mm <sup>2</sup>	- mm <sup>2</sup>	2.5 4 6 10
- mm	- mm	5 <sup>+</sup> 5 <sup>+</sup> 8 <sup>+</sup> 8 <sup>+</sup>
信号针	Signal Contacts	
-材料	-Material	铜合金 Copper Alloy
-表面处理	-Surface	镀银 Hard-silver Plated
-接触电阻	-Contact Resistance	$\leq 3m\Omega$
-轴向螺钉连接	-Axial Screw Terminal	
- mm <sup>2</sup>	-mm <sup>2</sup>	0.2-2.5mm <sup>2</sup>
- AWG	-AWG	24-14
-拧紧力矩	-Tightening Torque	0.8Nm
-剥线长度	-Stripping length	7.5mm

**电流负载能力 Current Carrying Capacity**

电流负载能力所受的限制主要来自包含接插针的接插体可承受的最大温度

The current carrying is limited by maximum temperature of materials for Inserts and contacts including terminals.

测试和控制过程依据 Measuring and testing techniques according to DIN EN 60512-5

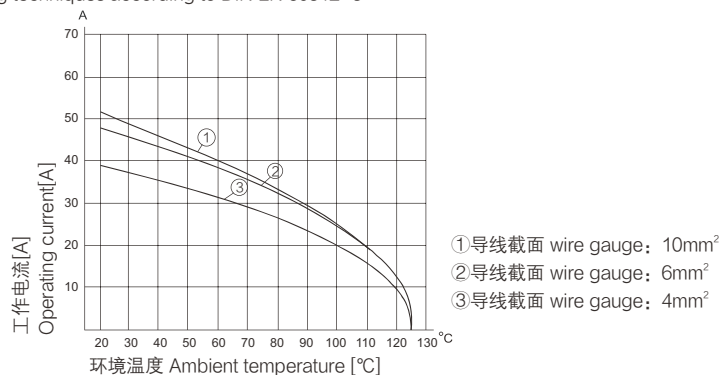



**Global District Limited**

HK-006/12 组合型插芯 Combination inserts 690/400V 40/10A 6/12+ ⊕

**插芯 Inserts**

外壳尺寸：匹配16B外壳，详情请参考17-01~17-21页

Hoods/Housings : Matching 16B Hood Housing , detail on P17-01~17-21

轴向螺栓连接/螺钉连接 Axial Screw Terminal/Screw terminal



插芯 Inserts	型号 Type	订货号 Part Number
公 Male	HK-006.1/12-M(2.5-8mm <sup>2</sup> )	09380182601
	HK-006.2/12-M(6-10mm <sup>2</sup> )	09380182602
母 Female	HK-006.1/12-F(2.5-8mm <sup>2</sup> )	09380182701
	HK-006.2/12-F(6-10mm <sup>2</sup> )	09380182702

接插体之间的最大距离21mm  
Distance for contact max.21mm

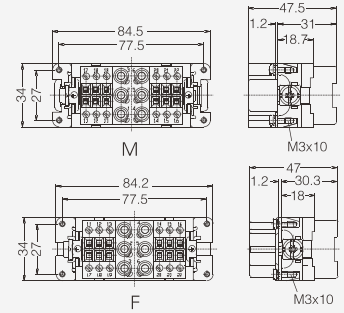

接插针排序  
Contacts arrangement view from termination side

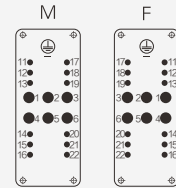

**附件 Accessories**

工具 Tools

内六角扳手  
hexagonal driver



描述 Description	型号 Type	订货号 Part Number
用于轴向夹紧螺栓 带T型把手 For Axial Setscrew With Grip	SW-2x40	09990000313



## HK-006/36 组合型插芯 Combination inserts

## 技术参数 Technical Characteristics

规范	Specifications	
规范	Specifications	DIN EN 60 664
		DIN EN 61 984
插芯	Inserts	
接插件针数	Number Of Contacts	6/36+PE
依据 EN 61 984的额定电压	Electrical Data Acc. To EN 61 984	
电力区	Power Area	
-额定电流	-Rated Current	40A
-额定电压	-Rated Voltage	690V
-额定脉冲电压	-Rated Impulse Voltage	8kV
-污染程度	-Pollution Degree	3
信号区	Signal Area	
-额定电流	-Rated Current	10A
-额定电压	-Rated Voltage	160V
-额定脉冲电压	-Rated Impulse Voltage	2.5kV
-污染程度	-Pollution Degree	3
-当污染程度2时的参数	-Pollution Degree 2 Also	10A 250V 4kV 2
依据UL/CSA额定电压	Rated Voltage Acc.to UI CSA	600/300V
绝缘电阻	Insulation Resistance	$\geq 10^{11} \Omega$
材料	Material	聚碳酸酯 Polycarbonate
工作温度范围	Limiting Temperatures	-40°C...+125°C
阻燃等级(UL94)	Flammability Acc. To UI94	V0
可拔插次数	Mechanical Working Life-mating Cycles	$\geq 500$
插针	Contacts	
强电针	Power Contacts	
-材料	-Material	铜合金 Copper Alloy
-表面处理	-Surface	镀银 Hard-silver Plated
		镀金 Hard-gold Plated
-接触电阻	-Contact Resistance	$\leq 0.3m\Omega$
-冷压连接	-Crimp Terminal	
- mm <sup>2</sup>	-mm <sup>2</sup>	1.5-6mm <sup>2</sup>
- AWG	-AWG	16-10
-最大绝缘直径	-Max. Insulation Diameter	5mm
信号针	Signal Contacts	
-材料	-Material	铜合金 Copper Alloy
-表面处理	-Surface	镀银 Hard-silver Plated
		镀金 Hard-gold Plated
-接触电阻	-Contact Resistance	$\leq 3m\Omega$
-冷压连接	-Crimp Terminal	
- mm <sup>2</sup>	-mm <sup>2</sup>	0.14-2.5mm <sup>2</sup>
- AWG	-AWG	26-14

## 电流负载能力 Current Carrying Capacity

电流负载能力所受的限制主要来自包含接插针的接插体可承受的最大温度

The current carrying is limited by maximum temperature of materials for Inserts and contacts including terminals.

测试和控制过程依据 Measuring and testing techniques according to DIN EN 60512-5

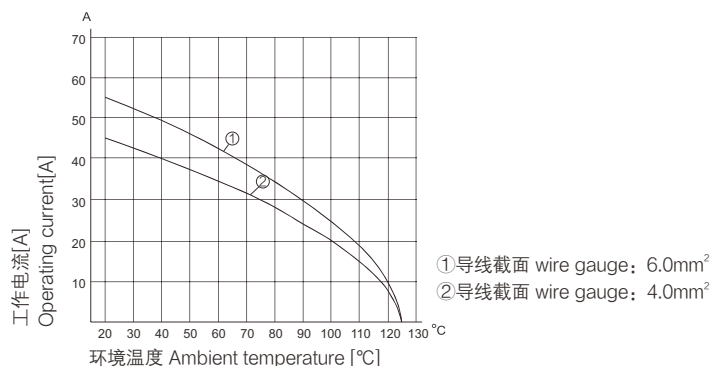



HK-006/36 组合型插芯 Combination inserts 690/160V 40/10A 6/36+⊕

插芯 Inserts

外壳尺寸：匹配16B外壳，详情请参考17-01~17-21页

Hoods/Housings：Matching 16B Hood Housing，detail on P17-01~17-21

冷压连接 Crimp Terminal



插芯 Inserts	型号 Type	订货号 Part Number
公 Male	HK-006/36-MC	09380423001
母 Female	HK-006/36-FC	09380423101

接插体之间的最大距离21mm  
Distance for contact max.21mm

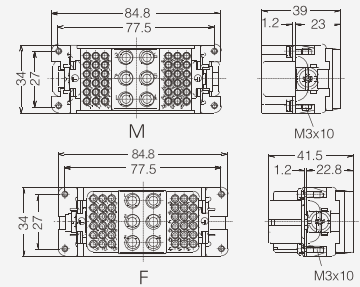

接插针排序  
Contacts arrangement view from termination side

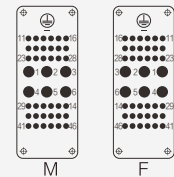

附件 Accessories

10A 冷压针 Crimp contacts

接触电阻 Contact resistance  $\leq 3m\Omega$   
镀银 Silver plated



公 Male	订货号 Part Number	母 Female	订货号 Part Number
CDSM-0.37	09150006104	CDSM-0.37	09150006204
CDSM-0.5	09150006103	CDSM-0.5	09150006203
CDSM-0.75	09150006105	CDSM-0.75	09150006205
CDSM-1.0	09150006102	CDSM-1.0	09150006202
CDSM-1.5	09150006101	CDSM-1.5	09150006201
CDSM-2.5	09150006106	CDSM-2.5	09150006206

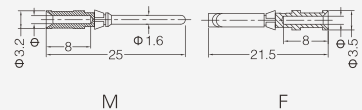

镀金 Gold plated



公 Male	订货号 Part Number	母 Female	订货号 Part Number
CDGM-0.37	09150006124	CDGM-0.37	09150006224
CDGM-0.5	09150006123	CDGM-0.5	09150006223
CDGM-0.75	09150006125	CDGM-0.75	09150006225
CDGM-1.0	09150006122	CDGM-1.0	09150006222
CDGM-1.5	09150006121	CDGM-1.5	09150006221
CDGM-2.5	09150006126	CDGM-2.5	09150006226

线规 Wire gauge	$\Phi$	剥线长度 Stripping length
0.14-0.37 mm <sup>2</sup> AWG 26-22	0.9	8 mm
0.5 mm <sup>2</sup> AWG 20	1.1	8 mm
0.75 mm <sup>2</sup> AWG 18	1.3	8 mm
1 mm <sup>2</sup> AWG 18	1.45	8 mm
1.5 mm <sup>2</sup> AWG 16	1.75	8 mm
2.5 mm <sup>2</sup> AWG 14	2.25	6 mm

40A 冷压针 Crimp contacts

接触电阻 Contact resistance  $\leq 1m\Omega$   
镀银 Silver plated



公 Male	订货号 Part Number	母 Female	订货号 Part Number
CCSM-1.5	09320006104	CCSF-1.5	09320006204
CCSM-2.5	09320006105	CCSF-2.5	09320006205
CCSM-4.0	09320006107	CCSF-4.0	09320006207
CCSM-6.0	09320006108	CCSF-6.0	09320006208

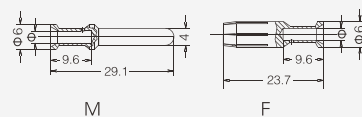

镀金 Gold plated



公 Male	订货号 Part Number	母 Female	订货号 Part Number
CCGM-1.5	09320006124	CCGF-1.5	09320006224
CCGM-2.5	09320006125	CCGF-2.5	09320006225
CCGM-4.0	09320006127	CCGF-4.0	09320006227
CCGM-6.0	09320006128	CCGF-6.0	09320006228

线规 Wire gauge	$\Phi$	剥线长度 Stripping length
1.5 mm <sup>2</sup> AWG 16	1.75	9 mm
2.5 mm <sup>2</sup> AWG 14	2.25	9 mm
4 mm <sup>2</sup> AWG 12	2.85	9.6 mm
6 mm <sup>2</sup> AWG 10	3.5	9.6 mm

工具 Tools

冷压钳 Crimping tool



压接线径 Wire gauge	型号 Type	订货号 Part Number
0.14-4mm <sup>2</sup>	TL02G	09990000021
1.5-6mm <sup>2</sup>	TL02-0G	09990000110

退针器 Removal tool



适用类型 For	型号 Type	订货号 Part Number
10A 冷压针 Crimp contacts	TL00	09990000012
40A 冷压针 Crimp contacts	TL06	099900000305



## HK-012/2 组合型插芯 Combination inserts

## 技术参数 Technical Characteristics

规范	Specifications	DIN EN 60 664
规范	Specifications	DIN EN 61 984
插芯	Inserts	
接插件针数	Number Of Contacts	12/2+PE
依据 EN 61 984的额定电压	Electrical Data Acc. To EN 61 984	
电力区	Power Area	
-额定电流	-Rated Current	40A
-额定电压	-Rated Voltage	690V
-额定脉冲电压	-Rated Impulse Voltage	8kV
-污染程度	-Pollution Degree	3
信号区	Signal Area	
-额定电流	-Rated Current	10A
-额定电压	-Rated Voltage	250V
-额定脉冲电压	-Rated Impulse Voltage	4kV
-污染程度	-Pollution Degree	3
依据UL/CSA额定电压	Rated Voltage Acc.to UI CSA	600/300V
绝缘电阻	Insulation Resistance	$\geq 10^{10} \Omega$
材料	Material	聚碳酸酯 Polycarbonate
工作温度范围	Limiting Temperatures	-40°C...+125°C
阻燃等级(UL94)	Flammability Acc. To UI94	V0
可拔插次数	Mechanical Working Life-mating Cycles	$\geq 500$
插针	Contacts	
强电针	Power Contacts	
-材料	-Material	铜合金 Copper Alloy
-表面处理	-Surface	镀银 Hard-silver Plated 镀金 Hard-gold Plated
-接触电阻	-Contact Resistance	$\leq 0.3m\Omega$
-冷压连接	-Crimp Terminal	
- mm <sup>2</sup>	-mm <sup>2</sup>	1.5-6mm <sup>2</sup>
- AWG	-AWG	16-10
-最大绝缘直径	-Max. Insulation Diameter	
信号针	Signal Contacts	铜合金 Copper Alloy
-材料	-Material	镀银 Hard-silver Plated 镀金 Hard-gold Plated
-表面处理	-Surface	$\leq 3m\Omega$
-接触电阻	-Contact Resistance	
-冷压连接	-Crimp Terminal	0.14-2.5mm <sup>2</sup>
- mm <sup>2</sup>	-mm <sup>2</sup>	26-14
- AWG	-AWG	

## 电流负载能力 Current Carrying Capacity

电流负载能力所受的限制主要来自包含接插针的接插体可承受的最大温度

The current carrying is limited by maximum temperature of materials for Inserts and contacts including terminals.

测试和控制过程依据 Measuring and testing techniques according to DIN EN 60512-5

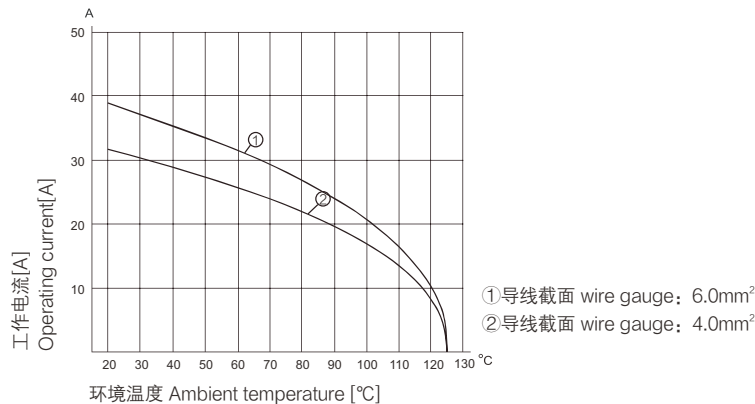



HK-012/2 组合型插芯 Combination inserts 690/250V 40/10A 12/2+⊕

插芯 Inserts

外壳尺寸：匹配16B外壳，详情请参考17-01~17-21页

Hoods/Housings：Matching 16B Hood Housing，detail on P17-01~17-21

冷压连接 Crimp Terminal



插芯 Inserts	型号 Type	订货号 Part Number
公 Male	HK-012/2-MC	09320123001
母 Female	HK-012/2-FC	09320123101

接插体之间的最大距离21mm  
Distance for contact max.21mm

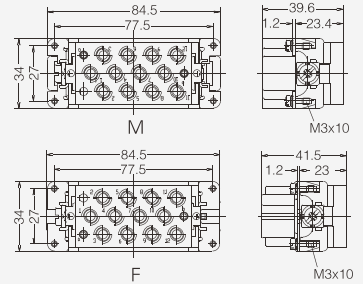

接插针排序

Contacts arrangement view from termination side

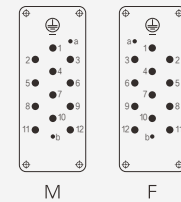

附件 Accessories

10A 冷压针 Crimp contacts

接触电阻 Contact resistance  $\leq 3m\Omega$   
镀银 Silver plated



公 Male	订货号 Part Number	母 Female	订货号 Part Number
CDSM-0.37	09150006104	CDSM-0.37	09150006204
CDSM-0.5	09150006103	CDSM-0.5	09150006203
CDSM-0.75	09150006105	CDSM-0.75	09150006205
CDSM-1.0	09150006102	CDSM-1.0	09150006202
CDSM-1.5	09150006101	CDSM-1.5	09150006201
CDSM-2.5	09150006106	CDSM-2.5	09150006206

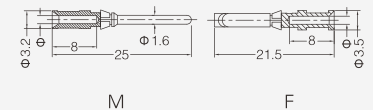

镀金 Gold plated



公 Male	订货号 Part Number	母 Female	订货号 Part Number
CDGM-0.37	09150006124	CDGM-0.37	09150006224
CDGM-0.5	09150006123	CDGM-0.5	09150006223
CDGM-0.75	09150006125	CDGM-0.75	09150006225
CDGM-1.0	09150006122	CDGM-1.0	09150006222
CDGM-1.5	09150006121	CDGM-1.5	09150006221
CDGM-2.5	09150006126	CDGM-2.5	09150006226

线规 Wire gauge	$\Phi$	剥线长度 Stripping length
0.14-0.37 mm <sup>2</sup> AWG 26-22	0.9	8 mm
0.5 mm <sup>2</sup> AWG 20	1.1	8 mm
0.75 mm <sup>2</sup> AWG 18	1.3	8 mm
1 mm <sup>2</sup> AWG 18	1.45	8 mm
1.5 mm <sup>2</sup> AWG 16	1.75	8 mm
2.5 mm <sup>2</sup> AWG 14	2.25	6 mm

40A 冷压针 Crimp contacts

接触电阻 Contact resistance  $\leq 1m\Omega$   
镀银 Silver plated



公 Male	订货号 Part Number	母 Female	订货号 Part Number
CCSM-1.5	09320006104	CCSF-1.5	09320006204
CCSM-2.5	09320006105	CCSF-2.5	09320006205
CCSM-4.0	09320006107	CCSF-4.0	09320006207
CCSM-6.0	09320006108	CCSF-6.0	09320006208

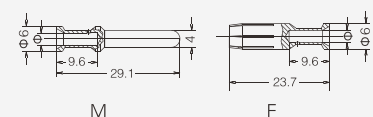

镀金 Gold plated



公 Male	订货号 Part Number	母 Female	订货号 Part Number
CCGM-1.5	09320006124	CCGF-1.5	09320006224
CCGM-2.5	09320006125	CCGF-2.5	09320006225
CCGM-4.0	09320006127	CCGF-4.0	09320006227
CCGM-6.0	09320006128	CCGF-6.0	09320006228

线规 Wire gauge	$\Phi$	剥线长度 Stripping length
1.5 mm <sup>2</sup> AWG 16	1.75	9 mm
2.5 mm <sup>2</sup> AWG 14	2.25	9 mm
4 mm <sup>2</sup> AWG 12	2.85	9.6 mm
6 mm <sup>2</sup> AWG 10	3.5	9.6 mm

工具 Tools

冷压钳 Crimping tool



压接线径 Wire gauge	型号 Type	订货号 Part Number
0.14-4mm <sup>2</sup>	TL02G	09990000021
1.5-6mm <sup>2</sup>	TL02-0G	09990000110

退针器 Removal tool



适用类型 For	型号 Type	订货号 Part Number
10A 冷压针 Crimp contacts	TL00	09990000012
40A 冷压针 Crimp contacts	TL06	099900000305



## HK-006/6 组合型插芯 Combination inserts

## 技术参数 Technical Characteristics

规范	Specifications	
规范	Specifications	DIN EN 60 664
		DIN EN 61 984
插芯	Inserts	
接插件针数	Number Of Contacts	6/6+PE
依据 EN 61 984的额定电压	Electrical Data Acc. To EN 61 984	
电力区	Power Area	
-额定电流	-Rated Current	100A
-额定电压	-Rated Voltage	690V
-额定脉冲电压	-Rated Impulse Voltage	8kV
-污染程度	-Pollution Degree	3
-当污染程度2时的参数	-Pollution Degree 2 Also	100A 1000V 8kV 2
信号区	Signal Area	
-额定电流	-Rated Current	16A
-额定电压	-Rated Voltage	400V
-额定脉冲电压	-Rated Impulse Voltage	6kV
-污染程度	-Pollution Degree	3
依据UL额定电压	Rated Voltage Acc.toUI	600/300V
依据UL/CSA额定电压	Rated Voltage Acc.to UI CSA	600/600V
依据UL/CSA额定电流	Rated Current Acc.to UI CSA	100/15A
绝缘电阻	Insulation Resistance	$\geq 10^{11}\Omega$
材料	Material	聚碳酸酯 Polycarbonate
工作温度范围	Limiting Temperatures	-40°C...+125°C
阻燃等级(UL94)	Flammability Acc. To UI94	V0
可拔插次数	Mechanical Working Life-mating Cycles	$\geq 500$
插针	Contacts	
强电针	Power Contacts	
-材料	-Material	铜合金 Copper Alloy
-表面处理	-Surface	镀银 Hard-silver Plated
-接触电阻	-Contact Resistance	$\leq 0.5m\Omega$
-轴向螺钉连接	-Axial Screw Terminal	
-mm <sup>2</sup>	-mm <sup>2</sup>	16-35mm <sup>2</sup>
-AWG	-AWG	5-2
-最大绝缘直径	-Max. Insulation Diameter	11.4mm
-拧紧力矩	-Tightening Torque	
-mm <sup>2</sup>	-mm <sup>2</sup>	16 25 35
-N.m	-N.m	6 7 8
-剥线长度	-Stripping length	13 <sup>+1</sup> mm
信号针	Signal Contacts	
-材料	-Material	铜合金 Copper Alloy
-表面处理	-Surface	镀银 Hard-silver Plated
-接触电阻	-Contact Resistance	$\leq 3m\Omega$
-轴向螺钉连接	-Axial Screw Terminal	
-mm <sup>2</sup>	-mm <sup>2</sup>	0.2-2.5mm <sup>2</sup>
-AWG	-AWG	24-13
-拧紧力矩	-Tightening Torque	0.8Nm
-剥线长度	-Stripping length	7.5mm

## 电流负载能力 Current Carrying Capacity

电流负载能力所受的限制主要来自包含接插针的接插体可承受的最大温度

The current carrying is limited by maximum temperature of materials for Inserts and contacts including terminals.

测试和控制过程依据 Measuring and testing techniques according to DIN EN 60512-5

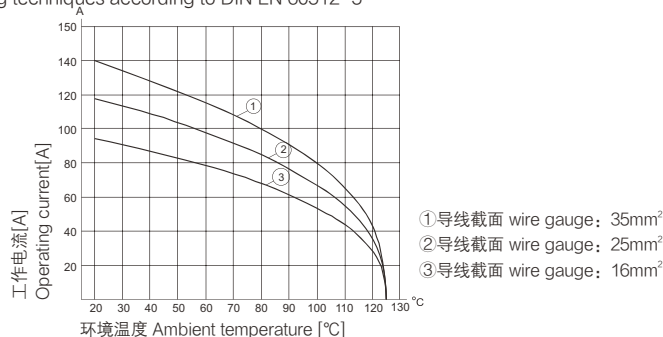



Global District Limited

HK-006/6 组合型插芯 Combination inserts 690/400V 100/16A 6/6+⊕

**插芯 Inserts**

外壳尺寸：匹配24B外壳，详情请参考18-01~18-22页

Hoods/Housings：Matching 24B Hood Housing，detail on P18-01~18-22

轴向螺钉连接 Axial Screw Terminal



插芯 Inserts	型号 Type	订货号 Part Number
公 Male	HK-006/6-M	09380122651
母 Female	HK-006/6-F	09380122751

接插体之间的最大距离21mm  
Distance for contact max.21mm

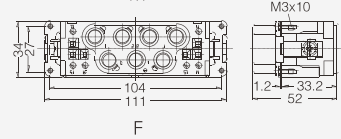
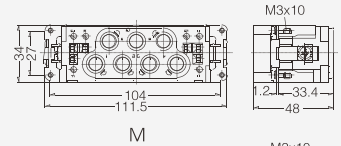

接插针排序  
Contacts arrangement view from termination side

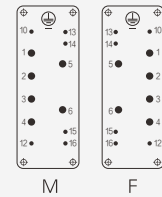

**附件 Accessories**

工具 Tools

内六角扳手  
hexagonal driver



描述 Description	型号 Type	订货号 Part Number
用于轴向夹紧螺栓 带T型把手 For Axial Setscrew With Grip	SW-4x100	09990000363





## HK-008/0 组合型插芯 Combination inserts

## 技术参数 Technical Characteristics

规范	Specifications	DIN EN 60 664
规范	Specifications	DIN EN 61 984
插芯	Inserts	
接插件针数	Number Of Contacts	8/0+PE
依据 EN 61 984的额定电压	Electrical Data Acc. To EN 61 984	
电力区	Power Area	
-额定电流	-Rated Current	100A
-额定电压	-Rated Voltage	690V
-额定脉冲电压	-Rated Impulse Voltage	8kV
-污染程度	-Pollution Degree	3
-当污染程度2时的参数	-Pollution Degree 2 Also	100A 1000V 8kV 2
依据UL/CSA额定电压	Rated Voltage Acc.to UI CSA	600V
依据UL/CSA额定电流	Rated Current Acc.to UI CSA	82A
绝缘电阻	Insulation Resistance	$\geq 10^{10} \Omega$
材料	Material	聚碳酸酯 Polycarbonate
工作温度范围	Limiting Temperatures	-40°C...+125°C
阻燃等级(UL94)	Flammability Acc. To UI94	V0
可拔插次数	Mechanical Working Life-mating Cycles	$\geq 500$
插针	Contacts	
材料	Material	铜合金 Copper Alloy
表面处理	Surface	镀银 Hard-silver Plated
接触电阻	Contact Resistance	$\leq 0.5m\Omega$
轴向螺钉连接	Axial Screw Terminal	
- mm <sup>2</sup>	-mm <sup>2</sup>	10-25mm <sup>2</sup>
- AWG	-AWG	7-3
最大绝缘直径	Max. Insulation Diameter	11.4mm
拧紧力矩	Tightening Torque	
- mm <sup>2</sup>	- mm <sup>2</sup>	10 16 25
- AWG	- AWG	6 6 7
剥线长度	Stripping length	13 <sup>+1</sup> mm

## 电流负载能力 Current Carrying Capacity

电流负载能力所受的限制主要来自包含接插针的接插体可承受的最大温度

The current carrying is limited by maximum temperature of materials for Inserts and contacts including terminals.

测试和控制过程依据 Measuring and testing techniques according to DIN EN 60512-5

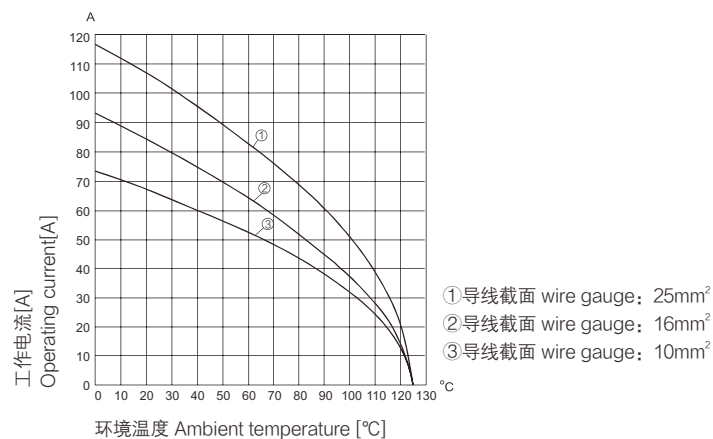



HK-008/0 组合型插芯 Combination inserts 690V/100A 8/0+ ⊕

**插芯 Inserts**

外壳尺寸：匹配24B外壳，详情请参考18-01~18-22页

Hoods/Housings : Matching 24B Hood Housing , detail on P18-01~18-22

轴向螺钉连接 Axial Screw Terminal



插芯 Inserts	型号 Type	订货号 Part Number
公 Male	HK-008/0-M	09380082653
母 Female	HK-008/0-F	09380082753

接插体之间的最大距离21mm  
Distance for contact max.21mm

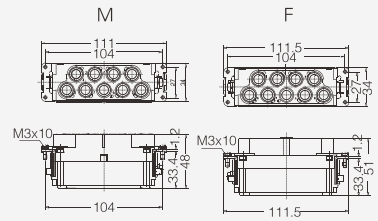

接插针排序  
Contacts arrangement view from termination side

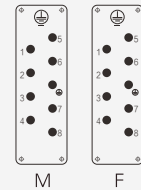

**附件 Accessories**

工具 Tools

内六角扳手  
hexagonal driver



描述 Description	型号 Type	订货号 Part Number
用于轴向夹紧螺栓 带T型把手 For Axial Setscrew With Grip	SW-4x100	09990000363



## HK-004/8 组合型插芯 Combination inserts

## 技术参数 Technical Characteristics

规范	Specifications	DIN EN 60 664
规范	Specifications	DIN EN 61 984
插芯	Inserts	
接插件针数	Number Of Contacts	4/8+PE
依据 EN 61 984的额定电压	Electrical Data Acc. To EN 61 984	
电力区	Power Area	
-额定电流	-Rated Current	80A
-额定电压	-Rated Voltage	400V
-额定脉冲电压	-Rated Impulse Voltage	6kV
-污染程度	-Pollution Degree	3
-当污染程度2时的参数	-Pollution Degree 2 Also	80A 400/690V 6kV 2
信号区	Signal Area	
-额定电流	-Rated Current	16A
-额定电压	-Rated Voltage	400V
-额定脉冲电压	-Rated Impulse Voltage	6kV
-污染程度	-Pollution Degree	3
依据UL/CSA额定电压	Rated Voltage Acc.to UI CSA	600/600V
绝缘电阻	Insulation Resistance	$\geq 10^{11} \Omega$
材料	Material	聚碳酸酯 Polycarbonate
工作温度范围	Limiting Temperatures	-40°C...+125°C
阻燃等级(UL94)	Flammability Acc. To UI94	V0
可拔插次数	Mechanical Working Life-mating Cycles	$\geq 500$
插针	Contacts	
电力区	Power Area	
-材料	-Material	铜合金 Copper Alloy
-表面处理	-Surface	镀银 Hard-silver Plated
-接触电阻	-Contact Resistance	$\leq 0.3m\Omega$
-螺钉连接	-Screw Terminal	
- mm <sup>2</sup>	-mm <sup>2</sup>	1.5-16mm <sup>2</sup>
- AWG	-AWG	16-6
-拧紧力矩	-Tightening Torque	
- mm <sup>2</sup>	- mm <sup>2</sup>	1.5 2.5 4 6 10 16
- N.m	- N.m	1.2 2 3 3 3 3
-剥线长度	-Stripping length	14mm
信号区	Signal Area	
-材料	-Material	铜合金 Copper Alloy
-表面处理	-Surface	镀银 Hard-silver Plated
-接触电阻	-Contact Resistance	$\leq 1m\Omega$
-螺钉连接	-Screw Terminal	
- mm <sup>2</sup>	-mm <sup>2</sup>	0.5-2.5mm <sup>2</sup>
- AWG	-AWG	20-14
-拧紧力矩	-Tightening Torque	0.5Nm
-剥线长度	-Stripping length	7.5mm

## 电流负载能力 Current Carrying Capacity

电流负载能力所受的限制主要来自包含接插针的接插体可承受的最大温度

The current carrying is limited by maximum temperature of materials for Inserts and contacts including terminals.

测试和控制过程依据 Measuring and testing techniques according to DIN EN 60512-5

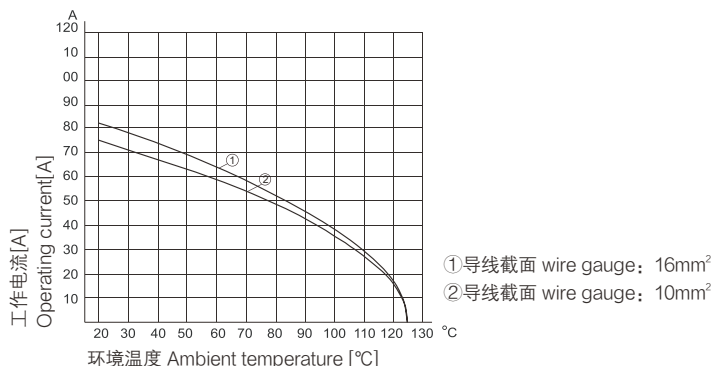



**Global District Limited**

HK-004/8 组合型插芯 Combination inserts 400/400V 80/16A 4/8+⊕

**插芯 Inserts**

外壳尺寸：匹配24B外壳，详情请参考18-01~18-22页

Hoods/Housings：Matching 24B Hood Housing，detail on P18-01~18-22

螺丝连接 Screw terminal



插芯 Inserts	型号 Type	订货号 Part Number
公 Male	HK-004/8-M	09380122601
母 Female	HK-004/8-F	09380122701

接插体之间的最大距离21mm

Distance for contact max.21mm

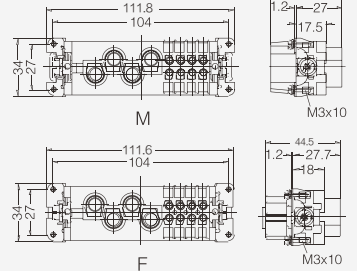

接插针排序

Contacts arrangement view from termination side

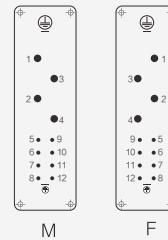



HE AV 系列 / HE AV SERIES

技术参数 Technical Characteristics

规范	Specifications	
规范	Specifications	DIN EN 60 664
		DIN EN 61 984
插芯	Inserts	
依据 EN 61 984的额定电压	Electrical Data Acc. To EN 61 984	
接插件针数	Number Of Contacts	6, 10, 16, 24, 32(2x16), 48(2x24)+PE
额定电流	Rated Current	16A
额定电压	Rated Voltage	500V
额定脉冲电压	Rated Impulse Voltage	6kV
污染程度	Pollution Degree	3
污染等级2时的参数	Pollution Degree 2 Also	16A 400/690V 6kV 2
依据UL/CSA额定电压	Rated Voltage Acc.to UI CSA	600V
绝缘电阻	Insulation Resistance	$\geq 10^{10}\Omega$
材料	Material	聚碳酸酯 Polycarbonate
工作温度范围	Limiting Temperatures	-40°C...+125°C
依据UL94阻燃等级	Flammability Acc. To UL94	V0
可拔插次数	Mechanical Working Life-mating Cycles	$\geq 500$
插针	Contacts	
材料	Material	铜合金 Copper Alloy
表面处理	Surface	
接合侧		镀银 Hard-Silver Plated
接线侧		镀锡 Tin plated
接触电阻	Contact Resistance	$\leq 4m\Omega$
螺钉连接	Screw Terminal	
mm <sup>2</sup>	mm <sup>2</sup>	0.2-2.5mm <sup>2</sup>
AWG	AWG	24-14
拧紧/检测力矩		0.5Nm
终端角夹		
mm <sup>2</sup>	mm <sup>2</sup>	0.14-2.5mm <sup>2</sup>
AWG	AWG	26-14

电流负载能力 Current Carrying Capacity

电流负载能力所受的限制主要来自包含接插针的接插体可承受的最大温度

The current carrying is limited by maximum temperature of materials for Inserts and contacts including terminals.

测试和控制过程依据 Measuring and testing techniques according to DIN EN 60512-5

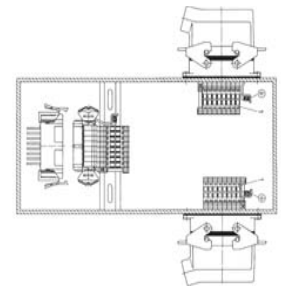
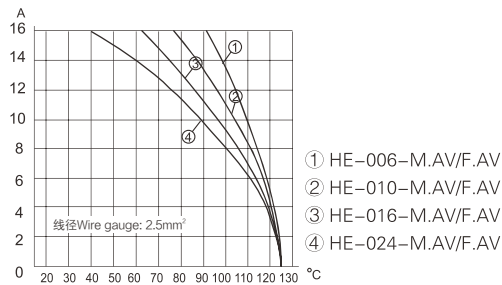
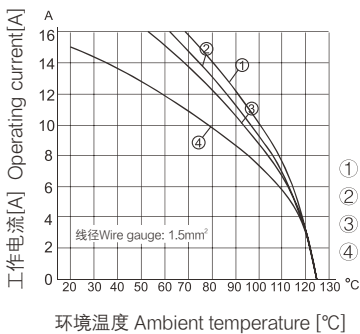



Global District Limited

HE AV 伸长型插芯 Extendible Inserts 500V 16A 6+⊕

插芯 Inserts

外壳尺寸：匹配6B不封底下壳外壳

Hoods/Housings : Matching 6B bulkhead mounting housings

公插芯 螺钉连接 Male Inserts Screw Terminal



规格Size	描述Description	型号 Type	订货号 Part Number
6B	左侧 Left Hand Version	HE-006-M.AV.L	09330064626
6B	右侧 Right Hand Version	HE-006-M.AV.R	09330064636

左侧  
Left Hand Version

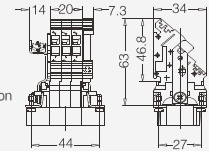

右侧  
Right Hand Version

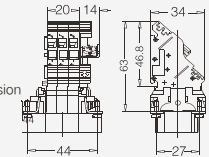

母插芯 螺钉连接 Female Inserts Screw Terminal



规格Size	描述Description	型号 Type	订货号 Part Number
6B	左侧 Left Hand Version	HE-006-F.AV.L	09330064726
6B	右侧 Right Hand Version	HE-006-F.AV.R	09330064736

左侧  
Left Hand Version

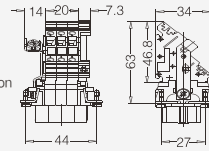

右侧  
Right Hand Version

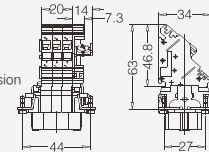



HE AV 伸长型插芯 Extendible Inserts 500V 16A 10+

插芯 Inserts

外壳尺寸：匹配10B 不封底下壳外壳

Hoods/Housings : Matching 10B bulkhead mounting housings

公插芯 螺钉连接 Male Inserts Screw Terminal



规格Size	描述Description	型号 Type	订货号 Part Number
10B	左侧 Left Hand Version	HE-010-M.AV.L	09330104626
10B	右侧 Right Hand Version	HE-010-M.AV.R	09330104636

左侧  
Left Hand Version

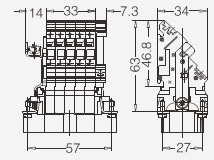

右侧  
Right Hand Version

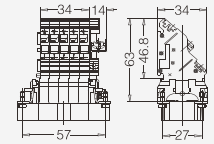

母插芯 螺钉连接 Female Inserts Screw Terminal



规格Size	描述Description	型号 Type	订货号 Part Number
10B	左侧 Left Hand Version	HE-010-F.AV.L	09330104726
10B	右侧 Right Hand Version	HE-010-F.AV.R	09330104736

左侧  
Left Hand Version

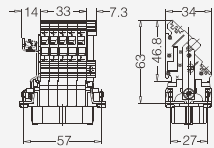

右侧  
Right Hand Version

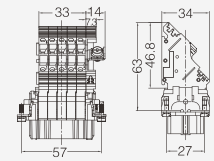

**Global District Limited**

HE AV 伸长型插芯 Extendible Inserts 500V 16A 16+

**插芯 Inserts**

外壳尺寸：匹配16B不封底下壳外壳

Hoods/Housings : Matching 16B bulkhead mounting housings

公插芯 螺钉连接 Male Inserts Screw Terminal

规格Size	描述Description	型号 Type	订货号 Part Number
16B	左侧 Left Hand Version	HE-016-M.AV.L	09330164626
16B	右侧 Right Hand Version	HE-016-M.AV.R	09330164636

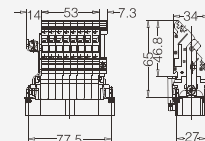
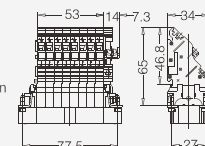
 左侧  
Left Hand Version

 右侧  
Right Hand Version

母插芯 螺钉连接 Female Inserts Screw Terminal

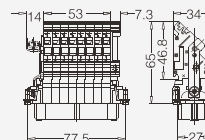
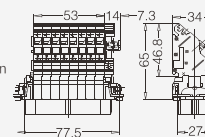
规格Size	描述Description	型号 Type	订货号 Part Number
16B	左侧 Left Hand Version	HE-016-F.AV.L	09330164726
16B	右侧 Right Hand Version	HE-016-F.AV.R	09330164736

 左侧  
Left Hand Version

 右侧  
Right Hand Version





HE AV 伸长型插芯 Extendible Inserts 500V 16A 24+ ⚡

插芯 Inserts

外壳尺寸：匹配24B 不封底下壳外壳

Hoods/Housings : Matching 24B bulkhead mounting housings

公插芯 螺钉连接 Male Inserts Screw Terminal



规格Size	描述Description	型号 Type	订货号 Part Number
24B	左侧 Left Hand Version	HE-024-M.AV.L	09330244626
24B	右侧 Right Hand Version	HE-024-M.AV.R	09330244636

左侧  
Left Hand Version

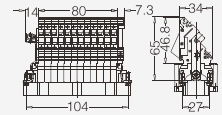

右侧  
Right Hand Version

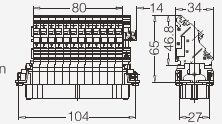

母插芯 螺钉连接 Female Inserts Screw Terminal



规格Size	描述Description	型号 Type	订货号 Part Number
24B	左侧 Left Hand Version	HE-024-F.AV.L	09330244726
24B	右侧 Right Hand Version	HE-024-F.AV.R	09330244736

左侧  
Left Hand Version

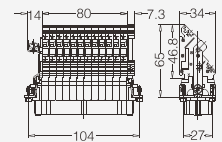

右侧  
Right Hand Version

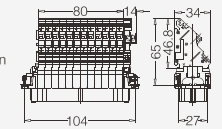



HM章节概要 Summary

模块一览 Module list

尺寸 Unit : 单位mm

 <p>H2MK-001-M H2MK-001-F</p>	插芯 Insert	200A 轴向压接型模块 200A Axial module
	插针数 Contacts	1
	连接方式 Terminal	轴向螺栓连接 Axial screw terminal
	额定电流 Rated current	200A
	额定电压 Rated voltage	1000V
	线径 Wire gauge	25-70mm <sup>2</sup>

 <p>H2MK-001-MC H2MK-001-FC</p>	插芯 Insert	200A 冷压型模块 200A Crimp module
	插针数 Contacts	1
	连接方式 Terminal	冷压连接 Crimp terminal
	额定电流 Rated current	200A
	额定电压 Rated voltage	1000V
	线径 Wire gauge	25-70mm <sup>2</sup>

 <p>HMK-001-MC HMK-001-FC</p>	插芯 Insert	100A 冷压型模块 100A Crimp module
	插针数 Contacts	1
	连接方式 Terminal	冷压连接 Crimp terminal
	额定电流 Rated current	100A
	额定电压 Rated voltage	830V
	线径 Wire gauge	10-35mm <sup>2</sup>

 <p>H2MK-002-M H2MK-002-F</p>	插芯 Insert	100A 轴向压接型模块 100A Axial module
	插针数 Contacts	2
	连接方式 Terminal	轴向螺栓连接 Axial screw terminal
	额定电流 Rated current	100A
	额定电压 Rated voltage	1000V
	线径 Wire gauge	10-35mm <sup>2</sup>

 <p>H2MK-002-MC H2MK-002-FC</p>	插芯 Insert	100A 冷压型模块 100A Crimp module
	插针数 Contacts	2
	连接方式 Terminal	冷压连接 Crimp terminal
	额定电流 Rated current	100A
	额定电压 Rated voltage	1000V
	线径 Wire gauge	10-35mm <sup>2</sup>

 <p>HMK70-002-M HMK70-002-F</p>	插芯 Insert	70A 冷压型模块 70A Axial module
	插针数 Contacts	2
	连接方式 Terminal	轴向螺栓连接 Axial screw terminal
	额定电流 Rated current	70A
	额定电压 Rated voltage	1000V
	线径 Wire gauge	6-22mm <sup>2</sup>

 <p>HMK70-002-MC HMK70-002-FC</p>	插芯 Insert	70A 冷压型模块 70A Crimp module
	插针数 Contacts	2
	连接方式 Terminal	冷压连接 Crimp terminal
	额定电流 Rated current	70A
	额定电压 Rated voltage	1000V
	线径 Wire gauge	10-25mm <sup>2</sup>

 <p>HMK-002-M HMK-002-F</p>	插芯 Insert	40A 轴向压接型模块 40A Axial module
	插针数 Contacts	2
	连接方式 Terminal	轴向螺栓连接 Axial screw terminal
	额定电流 Rated current	40A
	额定电压 Rated voltage	1000V
	线径 Wire gauge	2.5-10mm <sup>2</sup>

 <p>HMK-002-MC HMK-002-FC</p>	插芯 Insert	40A 冷压型模块 40A Crimp module
	插针数 Contacts	2
	连接方式 Terminal	冷压连接 Crimp terminal
	额定电流 Rated current	40A
	额定电压 Rated voltage	1000V
	线径 Wire gauge	1.5-10mm <sup>2</sup>

 <p>HMK-003-M HMK-003-F</p>	插芯 Insert	40A 轴向压接型模块 40A Axial module
	插针数 Contacts	3
	连接方式 Terminal	轴向螺栓连接 Axial screw terminal
	额定电流 Rated current	40A
	额定电压 Rated voltage	690V
	线径 Wire gauge	2.5-10mm <sup>2</sup>

 <p>HMK-003-MC HMK-003-FC</p>	插芯 Insert	40A 冷压型模块 40A Crimp module
	插针数 Contacts	3
	连接方式 Terminal	冷压连接 Crimp terminal
	额定电流 Rated current	40A
	额定电压 Rated voltage	500V
	线径 Wire gauge	1.5-10mm <sup>2</sup>

 <p>HMK-003/4-MC HMK-003/4-FC</p>	插芯 Insert	40/10A 冷压型模块 40/10A Crimp module
	插针数 Contacts	3/4
	连接方式 Terminal	冷压连接 Crimp terminal
	额定电流 Rated current	40A/10A
	额定电压 Rated voltage	830V
	线径 Wire gauge	1.5-6mm <sup>2</sup> /0.37-2.5mm <sup>2</sup>



## HM章节概要 Summary

## 结构框架类型 Construction Frame Version

尺寸 Unit : 单位mm

 <p>HMK-004-MC HMK-004-FC</p>	插芯 Insert	40A 冷压型模块 40A Crimp module	 <p>HME-005-MS HME-005-FS</p>	插芯 Insert	16A 弹片型模块 16A Cage-clamp module
	插针数 Contacts	4		插针数 Contacts	5
	连接方式 Terminal	冷压连接 Crimp terminal		连接方式 Terminal	笼式弹片连接 Cage clamp terminal
	额定电流 Rated current	40A		额定电流 Rated current	16A
	额定电压 Rated voltage	830V		额定电压 Rated voltage	400V
	线径 Wire gauge	1.5-6mm <sup>2</sup>		线径 Wire gauge	0.14-2.5mm <sup>2</sup>
 <p>HME-006-MC HME-006-FC</p>	插芯 Insert	16A 冷压型模块 16A Crimp module	 <p>HVME-006-MC HVME-006-FC</p>	插芯 Insert	16A 防护型模块 16A Protected module
	插针数 Contacts	6		插针数 Contacts	6
	连接方式 Terminal	冷压连接 Crimp terminal		连接方式 Terminal	冷压连接 Crimp terminal
	额定电流 Rated current	16A		额定电流 Rated current	16A
	额定电压 Rated voltage	500V		额定电压 Rated voltage	830V
	线径 Wire gauge	0.14-4mm <sup>2</sup>		线径 Wire gauge	0.14-4mm <sup>2</sup>
 <p>HMEE-008-MC HMEE-008-FC</p>	插芯 Insert	16A 冷压型模块 16A Crimp module	 <p>H2MEE-020-MC H2MEE-020-FC</p>	插芯 Insert	16A 冷压型模块 16A Crimp module
	插针数 Contacts	8		插针数 Contacts	20
	连接方式 Terminal	冷压连接 Crimp terminal		连接方式 Terminal	冷压连接 Crimp terminal
	额定电流 Rated current	16A		额定电流 Rated current	16A
	额定电压 Rated voltage	400V		额定电压 Rated voltage	500V
	线径 Wire gauge	0.14-4mm <sup>2</sup>		线径 Wire gauge	0.14-4mm <sup>2</sup>
 <p>HMD-012-MC HMD-012-FC</p>	插芯 Insert	10A 冷压型模块 10A Crimp module	 <p>HMDD-017-MC HMDD-017-FC</p>	插芯 Insert	10A 冷压型模块 10A Crimp module
	插针数 Contacts	12		插针数 Contacts	17
	连接方式 Terminal	冷压连接 Crimp terminal		连接方式 Terminal	冷压连接 Crimp terminal
	额定电流 Rated current	10A		额定电流 Rated current	10A
	额定电压 Rated voltage	250V		额定电压 Rated voltage	160V
	线径 Wire gauge	0.14-2.5mm <sup>2</sup>		线径 Wire gauge	0.14-2.5mm <sup>2</sup>
 <p>HMDS-009-MC HMDS-009-FC</p>	插芯 Insert	5A D-Sub模块 5A D-Sub module	 <p>HMDS-025-MC HMDS-025-FC</p>	插芯 Insert	4A 高密度型模块 4A High Density module
	插针数 Contacts	9		插针数 Contacts	25
	连接方式 Terminal	冷压连接 Crimp terminal		连接方式 Terminal	冷压连接 Crimp terminal
	额定电流 Rated current	5A		额定电流 Rated current	4A
	额定电压 Rated voltage	50V		额定电压 Rated voltage	50V
	线径 Wire gauge	0.09-0.82mm <sup>2</sup>		线径 Wire gauge	0.09-0.52mm <sup>2</sup>
 <p>HM-RJ45-M HM-RJ45-F</p>	插芯 Insert	1A RJ45模块 1A RJ45 module	气动模块 Pneumatic module		
	插针数 Contacts	8	2		
	连接方式 Terminal	用于接电缆 Module for patch cable	3		
	额定电流 Rated current	1A	 <p>HMP-002    <math>\phi 6</math> mm    HMP-003</p>		
	额定电压 Rated voltage	50V	<p><math>\phi 1.6</math> mm <math>\phi 3.0</math> mm <math>\phi 4.0</math> mm</p>		
	线径 Wire gauge				



Hm组合型模块 Modular connectors

模块一览 Module list

尺寸 Unit : 单位mm

产品系列 Series 连接方式 Terminal	H2M-002 冷压连接 Crimp terminal	EMC-001 冷压连接 Crimp terminal	EMC-004 冷压连接 Crimp terminal	EMC-008 冷压连接 Crimp terminal	APT-H2MQ
					
额定电流 Rated current 额定电压 Rated voltage 线规 Wire gauge		16A 50V 0.09-2.5mm <sup>2</sup>	10A 50V 0.09-2.5mm <sup>2</sup>	5A 50V 0.09-0.52mm <sup>2</sup>	Q-Coax金属适配器 Adapter



HM模块框架 Hinged Frames

**结构框架类型 Construction Frame Version**

尺寸 Unit : 单位mm

6B 活动框架 适用所有6B外壳 / 6B frame, size 6B hoods/housings



描述 Description	标示Marking	型号 Type	订货号 Part Number
用于2个模块 for 2 modules	A-B	HF6B-NUA	09140060303
用于2个模块 for 2 modules	a-b	HF6B-NLA	09140060313

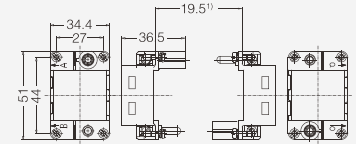

10B 活动框架 适用所有10B外壳 / 10B frame, size 10B hoods/housings



描述 Description	标示Marking	型号 Type	订货号 Part Number
用于3个模块 for 3 modules	A-C	HF10B-NUA	09140100303
用于3个模块 for 3 modules	a-c	HF10B-NLA	09140100313

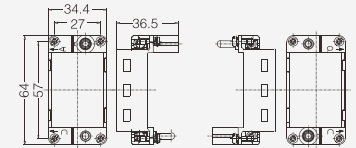

16B 活动框架 适用所有16B外壳 / 16B frame, size 16B hoods/housings



描述 Description	标示Marking	型号 Type	订货号 Part Number
用于4个模块 for 4 modules	A-D	HF16B-NUA	09140160303
用于4个模块 for 4 modules	a-d	HF16B-NLA	09140160313

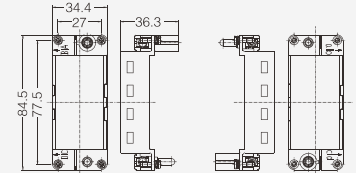

24B 活动框架 适用所有24B外壳 / 24B frame, size 24B hoods/housings



描述 Description	标示Marking	型号 Type	订货号 Part Number
用于6个模块 for 6 modules	A-F	HF24B-NUA	09140240303
用于6个模块 for 6 modules	a-f	HF24B-NLA	09140240313

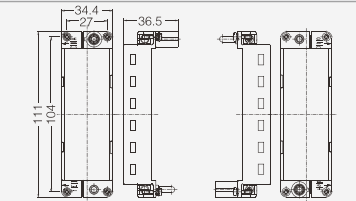

空置模块 / Filling module



描述 Description	型号 Type	订货号 Part Number
用于填充固定框架内剩余的模块空间	HM-000	09140009950

**模块拆装示意图 Modules Dismounting Instructions**

装配示意图 Assembly instructions

拆卸过程反之 Disassembly process is on the contrary.



装配前松开滑动边框

Loosen sliding border before assembly

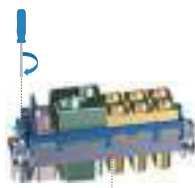

装配好模块后, 闭合滑动边框, 锁上螺丝

After finished assembly, close sliding border, lock screw



H2MK-001 轴向压接型模块 Axial Module 1000V 200A

插芯 Inserts



可与框架及其他所有模块产品组合使用  
Combination with hinged frame and other modules possible.

技术参数 Technical Characteristics

规范	Specifications	
规范	Specifications	DIN EN 60 664
		DIN EN 61 984
插芯	Inserts	
接插件针数	Number Of Contacts	1
依据 EN 61 984 的电气数据	Electrical Data Acc. To EN 61 984	
-额定电流	-Rated Current	200A
-额定电压	-Rated Voltage	1000V
-额定脉冲电压	-Rated Impulse Voltage	8kV
-污染程度	-Pollution Degree	3
依据UL/CSA额定电压	Rated Voltage Acc.to UI CSA	600V
绝缘电阻	Insulation Resistance	$\geq 10^{10} \Omega$
材料	Material	聚碳酸酯 Polycarbonate
工作温度范围	Limiting Temperatures	-40°C...+125°C
依据UL 94 的阻燃等级	Flammability Acc. To UI94	V0
可拔插次数	Mechanical Working Life-mating Cycles	$\geq 500$
插针	Contacts	
材料	Material	铜合金 Copper Alloy
表面处理	Surface	镀银 Hard-silver Plated
接触电阻	Contact Resistance	0.2m $\Omega$
电缆绞线依据IEC 60 228-5	To IEC 60 228 Class 5	
轴向螺栓连接	Axial Screw Terminal	
- mm <sup>2</sup>	-mm <sup>2</sup>	25-70mm <sup>2</sup>
- AWG	-AWG	2-0
- 内六角扳手	-Hexagonal Driver	SW 5
- 剥线长度	-Stripping length	16mm
- 拧紧力矩	-Tightening Torque	
- mm <sup>2</sup>	- mm <sup>2</sup>	25 35 50 70
- Nm	- Nm	8 8 9 10

电流负载能力 Current Carrying Capacity

电流负载能力所受的限制主要来自包含接插针的接插体可承受的最大温度  
测试和控制过程依据 DIN EN 60512-5  
The current carrying is limited by maximum temperature of materials for inserts and contacts including terminals.  
Measuring and testing techniques according to DIN EN 60512-5

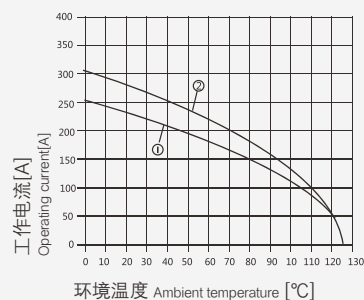

- ① 24B外壳带3个模块，导线截面：50mm<sup>2</sup>
- ② 24B外壳带3个模块，导线截面：70mm<sup>2</sup>
- ① 24 B hoods/housings with 3 modules, wire gauge:50mm<sup>2</sup>
- ② 24 B hoods/housings with 3 modules, wire gauge:70mm<sup>2</sup>

轴向螺栓连接 Axial Screw Terminal

插芯 Inserts	型号 Type	订货号 Part Number
公 Male	H2MK-001.1-M(25-40mm <sup>2</sup> )	09140012663
	H2MK-001.2-M(40-70mm <sup>2</sup> )	09140012662
母 Female	H2MK-001.1-F(25-40mm <sup>2</sup> )	09140012763
	H2MK-001.2-F(40-70mm <sup>2</sup> )	09140012762

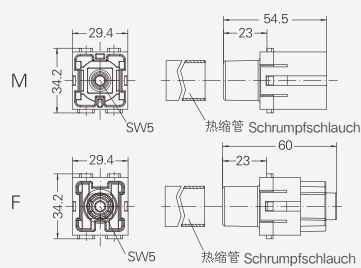

附件 Accessories

工具 Tools

内六角扳手 Hexagonal driver	描述 Description	型号 Type	订货号 Part Number
	用于轴向夹紧螺栓 带T型把手 For Axial Setscrew With Grip	SW-5x150	09990000364



Global District Limited

H2MK-001 冷压型模块 Crimp Module 1000V 200A

插芯 Inserts



可与框架及其他所有模块产品组合使用

Combination with hinged frame and other modules possible.

技术参数 Technical Characteristics

规范	Specifications	
规范	Specifications	DIN EN 60 664
		DIN EN 61 984
插芯	Inserts	
接插件针数	Number Of Contacts	1
依据 EN 61 984 的电气数据	Electrical Data Acc. To EN 61 984	
-额定电流	-Rated Current	200A
-额定电压	-Rated Voltage	1000V
-额定脉冲电压	-Rated Impulse Voltage	8kV
-污染程度	-Pollution Degree	3
绝缘电阻	Insulation Resistance	$\geq 10^{10} \Omega$
材料	Material	聚碳酸酯 Polycarbonate
工作温度范围	Limiting Temperatures	-40°C...+125°C
依据UL 94的阻燃等级	Flammability Acc. To UI94	V0
可拔插次数	Mechanical Working Life-mating Cycles	$\geq 500$
插针	Contacts	
材料	Material	铜合金 Copper Alloy
表面处理	Surface	镀银 Hard-silver Plated
接触电阻	Contact Resistance	$\leq 0.3m\Omega$
冷压连接	Crimp Terminal	
- mm <sup>2</sup>	- mm <sup>2</sup>	25-70mm <sup>2</sup>
剥线长度	Stripping length	22.5mm
最大电缆直径	Max. insulation diameter	18mm

电流负载能力 Current Carrying Capacity

电流负载能力所受的限制主要来自包含插针的接插体可承受的最大温度

测试和控制过程依据 DIN EN 60512-5

The current carrying is limited by maximum temperature of materials for Inserts and contacts including terminals.

Measuring and testing techniques according to DIN EN 60512-5

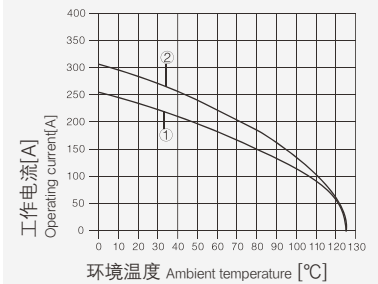

① 24B外壳带3个模块，导线截面：50mm<sup>2</sup>

② 24B外壳带3个模块，导线截面：70mm<sup>2</sup>

① 24 B hoods/housings with 3 modules, wire gauge:50mm<sup>2</sup>

② 24 B hoods/housings with 3 modules, wire gauge:70mm<sup>2</sup>

冷压连接 Crimp Terminal



插芯 Inserts	型号 Type	订货号 Part Number
公 Male	H2MK-001-MC	09140013001
母 Female	H2MK-001-FC	09140013101

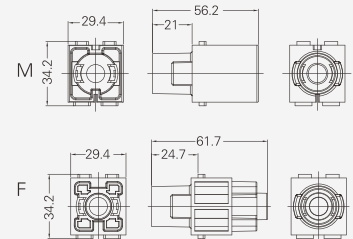

附件 Accessories

200A 冷压针 Crimp contacts

接触电阻  $\leq 0.3 m\Omega$   
Contact resistance  $\leq 0.3 m\Omega$   
镀银 silver plated



公 Male	订货号 Part Number	母 Female	订货号 Part Number
CHSM200-25	09110006120	CHSF200-25	09110006220
CHSM200-35	09110006121	CHSF200-35	09110006221
CHSM200-50	09110006122	CHSF200-50	09110006222
CHSM200-70	09110006123	CHSF200-70	09110006223

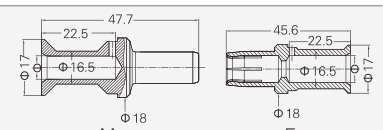

导线截面 Wire gauge	φ	剥线长度 Stripping length
25 mm <sup>2</sup>	7	22.5 mm
35 mm <sup>2</sup>	8.2	22.5 mm
50 mm <sup>2</sup>	10	22.5 mm
70 mm <sup>2</sup>	11.5	22.5 mm

电镀锌线依据 IEC 60 228-5  
for stranded wire according to IEC 60 228 Class 5

工具 Tools

液压钳  
Manual hydraulic clamp



压接线径 Wire gauge	型号 Type	订货号 Part Number
10-240mm <sup>2</sup>	TL05	09990000385



HMK-001 冷压型模块 Crimp Module 830V 100A

插芯 Inserts



可与框架及其他所有模块产品组合使用  
Combination with hinged frame and other modules possible.

技术参数 Technical Characteristics

规范	Specifications	
规范	Specifications	DIN EN 60 664
		DIN EN 61 984
插芯	Inserts	
接插件针数	Number Of Contacts	1
依据 EN 61 984的电气数据	Electrical Data Acc. To EN 61 984	
-额定电流	-Rated Current	100A
-额定电压	-Rated Voltage	830V
-额定脉冲电压	-Rated Impulse Voltage	8kV
-污染程度	-Pollution Degree	3
绝缘电阻	Insulation Resistance	$\geq 10^{10}\Omega$
材料	Material	聚碳酸酯 Polycarbonate
工作温度范围	Limiting Temperatures	-40°C...+125°C
依据UL 94的阻燃等级	Flammability Acc. To UI94	V0
可拔插次数	Mechanical Working Life-mating Cycles	$\geq 500$
最大电缆直径	Max. insulation diameter	13mm
插针	Contacts	
材料	Material	铜合金 Copper Alloy
表面处理	Surface	镀银 Hard-silver Plated
接触电阻	Contact Resistance	$\leq 0.3m\Omega$
冷压连接	Crimp Terminal	
- mm <sup>2</sup>	- mm <sup>2</sup>	10-35mm <sup>2</sup>

冷压连接 Crimp Terminal



插芯 Inserts	型号 Type	订货号 Part Number
公 Male	HMK-001-MC	09140013003
母 Female	HMK-001-FC	09140013103

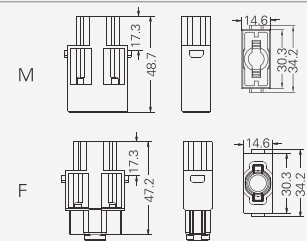

附件 Accessories

100A 冷压针 Crimp contacts

接触电阻  $\leq 0.3 m\Omega$   
Contact resistance  $\leq 0.3 m\Omega$   
镀银 silver plated



公 Male	订货号 Part Number	母 Female	订货号 Part Number
CKSM-10	09110006114	CKSF-10G	09110006214
CKSM-16	09110006116	CKSF-16G	09110006216
CKSM-25	09110006125	CKSF-25G	09110006225
CKSM-35	09110006135	CKSF-35G	09110006235

线规 Wire gauge(mm<sup>2</sup>)

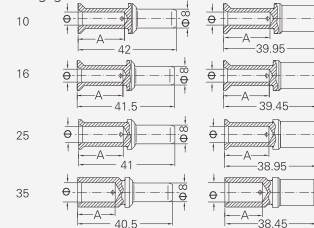

导线截面 Wire gauge	Φ	剥线长度(A) Stripping length
10 mm <sup>2</sup>	4.3	19 mm
16 mm <sup>2</sup>	5.5	19 mm
25 mm <sup>2</sup>	7	19 mm
35 mm <sup>2</sup>	8.2	16 mm

电绞线依据 IEC 60 228-5  
for stranded wire according to IEC 60 228 Class 5

工具 Tools



液压钳 Manual hydraulic clamp	压接线规 Wire gauge 10-240mm <sup>2</sup>	型号 Type TL05	订货号 Part Number 09990000385
-------------------------------	--	-----------------	--------------------------------

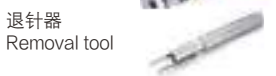

退针器 Removal tool	适用类型 For 100A 冷压针 Crimp contacts	型号 Type TL11	订货号 Part Number 09990000383
---------------------	-------------------------------------	-----------------	--------------------------------





Global District Limited

H2MK-002 轴向压接型模块 Axial Module 1000V 100A

插芯 Inserts



可与框架及其他所有模块产品组合使用  
Combination with hinged frame and other modules possible.

技术参数 Technical Characteristics

规范	Specifications	
规范	Specifications	DIN EN 60 664
		DIN EN 61 984
插芯	Inserts	
接插件针数	Number Of Contacts	2
依据 EN 61 984 的电气数据	Electrical Data Acc. To EN 61 984	
- 额定电流	- Rated Current	100A
- 额定电压	- Rated Voltage	1000V
- 额定脉冲电压	- Rated Impulse Voltage	8kV
- 污染程度	- Pollution Degree	3
依据 UL 的额定电压	Rated Voltage Acc. to UL	600V
绝缘电阻	Insulation Resistance	$\geq 10^{10} \Omega$
材料	Material	聚碳酸酯 Polycarbonate
工作温度范围	Limiting Temperatures	-40°C...+125°C
依据 UL 94 的阻燃等级	Flammability Acc. To UL94	V0
可拔插次数	Mechanical Working Life-mating Cycles	$\geq 500$
插针	Contacts	
材料	Material	铜合金 Copper Alloy
表面处理	Surface	镀银 Hard-silver Plated
接触电阻	Contact Resistance	0.3mΩ
电缆绞线依据 IEC 60 228-5	To IEC 60 228 Class 5	
轴向螺栓连接	Axial Screw Terminal	
- mm <sup>2</sup>	- mm <sup>2</sup>	10-38mm <sup>2</sup>
- AWG	- AWG	6-2
- 内六角扳手	- Hexagonal Driver	SW 4
- 剥线长度	- Stripping length	13mm
- 拧紧力矩	- Tightening Torque	
- mm <sup>2</sup>	- mm <sup>2</sup>	10 16 25 35
- Nm	- Nm	6 6 7 8

电流负载能力 Current Carrying Capacity

电流负载能力所受的限制主要来自包含接插针的接插体可承受的最大温度  
测试和控制过程依据 DIN EN 60512-5  
The current carrying is limited by maximum temperature of materials for Inserts and contacts including terminals.  
Measuring and testing techniques according to DIN EN 60512-5

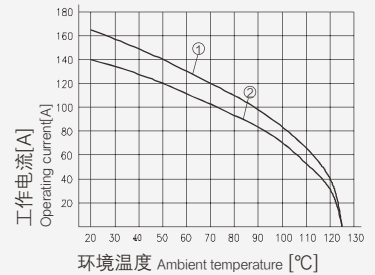

- ① 24B外壳带3个模块，导线截面：35mm<sup>2</sup>
- ② 24B外壳带3个模块，导线截面：25mm<sup>2</sup>
- ① 24 B hoods/housings with 3 modules, wire gauge:35mm<sup>2</sup>
- ② 24 B hoods/housings with 3 modules, wire gauge:25mm<sup>2</sup>

轴向螺栓连接 Axial Screw Terminal

插芯 Inserts	型号 Type	订货号 Part Number
公 Male	H2MK-002.1-M(10-25mm <sup>2</sup> )	09140022653
	H2MK-002.2-M(16-35mm <sup>2</sup> )	09140022651
	H2MK-002.1-M(38mm <sup>2</sup> )	09140022650
母 Female	H2MK-002.1-F(10-25mm <sup>2</sup> )	09140022753
	H2MK-002.2-F(16-35mm <sup>2</sup> )	09140022751
	H2MK-002.1-F(38mm <sup>2</sup> )	09140022750

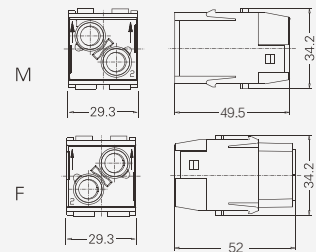

附件 Accessories

电缆终端 Cable shoe 16mm<sup>2</sup>



描述 Description	型号 Type	订货号 Part Number
用于PE扩展 For PE extension	PE-E16	09140009912

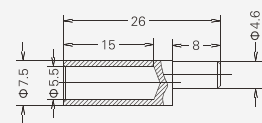

工具 Tools

内六角扳手  
Hexagonal driver



描述 Description	型号 Type	订货号 Part Number
用于轴向夹紧螺栓 带T型把手 For Axial Setscrew With Grip	SW-4x100	09990000363

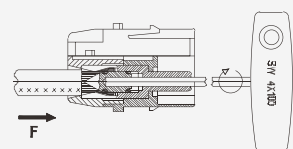



H2MK-002 冷压型模块 Crimp Module 1000V 100A

插芯 Inserts



可与框架及其他所有模块产品组合使用  
Combination with hinged frame and other modules possible.

技术参数 Technical Characteristics

规范	Specifications	
规范	Specifications	DIN EN 60 664
		DIN EN 61 984
插芯	Inserts	
接插件针数	Number Of Contacts	2
依据 EN 61 984 的电气数据	Electrical Data Acc. To EN 61 984	
-额定电流	-Rated Current	100A
-额定电压	-Rated Voltage	1000V
-额定脉冲电压	-Rated Impulse Voltage	8kV
-污染程度	-Pollution Degree	3
绝缘电阻	Insulation Resistance	$\geq 10^{10}\Omega$
材料	Material	聚碳酸酯 Polycarbonate
工作温度范围	Limiting Temperatures	-40°C...+125°C
依据UL 94的阻燃等级	Flammability Acc. To UI94	V0
可拔插次数	Mechanical Working Life-mating Cycles	$\geq 500$
插针	Contacts	
材料	Material	铜合金 Copper Alloy
表面处理	Surface	镀银 Hard-silver Plated
接触电阻	Contact Resistance	$\leq 0.3m\Omega$
冷压连接	Crimp Terminal	
- mm <sup>2</sup>	- mm <sup>2</sup>	10-35mm <sup>2</sup>
最大电缆直径	Max. insulation diameter	14mm

电流负载能力 Current Carrying Capacity

电流负载能力所受的限制主要来自包含接插针的接插体可承受的最大温度  
测试和控制过程依据 DIN EN 60512-5  
The current carrying is limited by maximum temperature of materials for inserts and contacts including terminals.  
Measuring and testing techniques according to DIN EN 60512-5

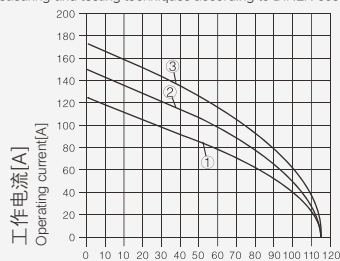

- 环境温度 Ambient temperature [°C]
- ① 24B外壳带3个模块, 导线截面: 16mm<sup>2</sup>
  - ② 24B外壳带3个模块, 导线截面: 25mm<sup>2</sup>
  - ③ 24B外壳带3个模块, 导线截面: 35mm<sup>2</sup>
- ① 24 B hoods/housings with 3 modules, wire gauge:16mm<sup>2</sup>  
② 24 B hoods/housings with 3 modules, wire gauge:25mm<sup>2</sup>  
③ 24 B hoods/housings with 3 modules, wire gauge:35mm<sup>2</sup>

冷压连接 Crimp Terminal



插芯 Inserts	型号 Type	订货号 Part Number
公 Male	H2MK-002-MC	09140023051
母 Female	H2MK-002-FC	09140023151

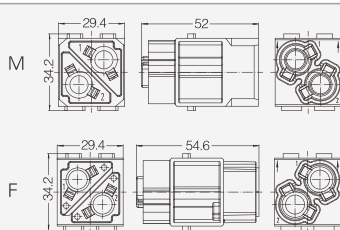

附件 Accessories

100A 冷压针 Crimp contacts

接触电阻  $\leq 0.3 m\Omega$   
Contact resistance  $\leq 0.3 m\Omega$   
镀银 silver plated



公 Male	订货号 Part Number	母 Female	订货号 Part Number
CKSM-10	09110006114	CKSF-10G	09110006214
CKSM-16	09110006116	CKSF-16G	09110006216
CKSM-25	09110006125	CKSF-25G	09110006225
CKSM-35	09110006135	CKSF-35G	09110006235

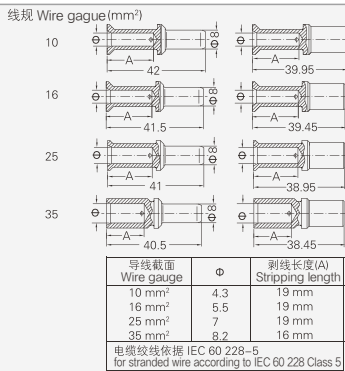

工具 Tools



压接线径 Wire gauge	型号 Type	订货号 Part Number
10-240mm <sup>2</sup>	TL05	09990000385
适用类型 For	型号 Type	订货号 Part Number
100A 冷压针 Crimp contacts	TL07	09990000383



**HMK70-002 轴向压接型模块 Axial Module 1000V 70A**

**插芯 Inserts**



可与框架及其他所有模块产品组合使用  
Combination with hinged frame and other modules possible.

**技术参数 Technical Characteristics**

规范	Specifications	
规范	Specifications	DIN EN 60 664
		DIN EN 61 984
插芯	Inserts	
接插件针数	Number Of Contacts	2
依据 EN 61 984 的电气数据	Electrical Data Acc. To EN 61 984	
-额定电流	-Rated Current	70A
-额定电压	-Rated Voltage	1000V
-额定脉冲电压	-Rated Impulse Voltage	8kV
-污染程度	-Pollution Degree	3
依据UL的额定电压	Rated Voltage Acc.to UL	600V
绝缘电阻	Insulation Resistance	≥ 10 <sup>10</sup> Ω
材料	Material	聚碳酸酯 Polycarbonate
工作温度范围	Limiting Temperatures	-40°C...+125°C
依据UL 94的阻燃等级	Flammability Acc. To UL94	V0
可拔插次数	Mechanical Working Life-mating Cycles	≥500
插针	Contacts	
材料	Material	铜合金 Copper Alloy
表面处理	Surface	镀银 Hard-silver Plated
接触电阻	Contact Resistance	0.5m Ω
电缆绞线依据IEC 60 228-5	To IEC 60 228 Class 5	
轴向螺栓连接	Axial Screw Terminal	
- mm <sup>2</sup>	-mm <sup>2</sup>	6-22mm <sup>2</sup>
- AWG	-AWG	8-4
- 内六角扳手	-Hexagonal Driver	SW 2.5
- 剥线长度	-Stripping length	
- mm <sup>2</sup>	- mm <sup>2</sup>	6 10 16 22
- mm	- mm	11 <sup>+1</sup> 11 <sup>+1</sup> 11 <sup>+1</sup> 12.5 <sup>+1</sup>
- 拧紧力矩	-Tightening Torque	
- mm <sup>2</sup>	- mm <sup>2</sup>	6 10 16 22
- Nm	- Nm	2 3 4 5

**电流负载能力 Current Carrying Capacity**

电流负载能力所受的限制主要来自包含接插针的接插体可承受的最大温度  
测试和控制过程依据 DIN EN 60512-5  
The current carrying is limited by maximum temperature of materials for Inserts and contacts including terminals.  
Measuring and testing techniques according to DIN EN 60512-5

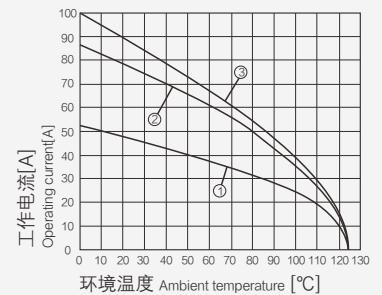

- ① 24B外壳带6个模块，导线截面：6mm<sup>2</sup>
- ② 24B外壳带6个模块，导线截面：16mm<sup>2</sup>
- ③ 24B外壳带6个模块，导线截面：22mm<sup>2</sup>
- ① 24 B hoods/housings with 6 modules, wire gauge:6mm<sup>2</sup>
- ② 24 B hoods/housings with 6 modules, wire gauge:16mm<sup>2</sup>
- ③ 24 B hoods/housings with 6 modules, wire gauge:22mm<sup>2</sup>

**轴向螺栓连接 Axial Screw Terminal**



插芯 Inserts	型号 Type	订货号 Part Number
公 Male	HMK70-002.1-M(6-16mm <sup>2</sup> )	09140022646
	HMK70-002.2-M(14-22mm <sup>2</sup> )	09140022647
母 Female	HMK70-002.1-F(6-16mm <sup>2</sup> )	09140022741
	HMK70-002.2-F(14-22mm <sup>2</sup> )	09140022742

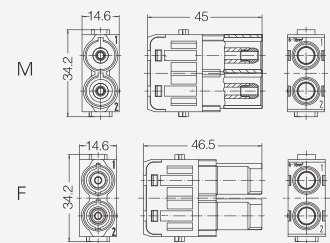

**附件 Accessories**

**工具 Tools**

内六角扳手  
Hexagonal driver



描述 Description	型号 Type	订货号 Part Number
用于轴向夹紧螺栓 带T型把手 For Axial Setscrew With Grip	SW-2.5x100	0999000313



HMK70-002 冷压型模块 Crimp Module 1000V 70A

插芯 Inserts



可与框架及其他所有模块产品组合使用  
Combination with hinged frame and other modules possible.

技术参数 Technical Characteristics

规范	Specifications	
规范	Specifications	DIN EN 60 664 DIN EN 61 984
插芯	Inserts	
接插件针数	Number Of Contacts	2
依据 EN 61 984的电气数据	Electrical Data Acc. To EN 61 984	
-额定电流	-Rated Current	70A
-额定电压	-Rated Voltage	1000V
-额定脉冲电压	-Rated Impulse Voltage	8kV
-污染程度	-Pollution Degree	3
绝缘电阻	Insulation Resistance	$\geq 10^{10} \Omega$
材料	Material	聚碳酸酯 Polycarbonate
工作温度范围	Limiting Temperatures	-40°C...+125°C
依据UL 94的阻燃等级	Flammability Acc. To UI94	V0
可拔插次数	Mechanical Working Life-mating Cycles	$\geq 500$
插针	Contacts	
材料	Material	铜合金 Copper Alloy
表面处理	Surface	镀银 Hard-silver Plated
接触电阻	Contact Resistance	$\leq 0.5m\Omega$
冷压连接	Crimp Terminal	
- mm <sup>2</sup>	- mm <sup>2</sup>	10-25mm <sup>2</sup>
剥线长度	Stripping length	15.5mm
最大电缆直径	Max. insulation diameter	11mm

冷压连接 Crimp Terminal



插芯 Inserts	型号 Type	订货号 Part Number
公 Male	HMK70-002-MC	09140022761
母 Female	HMK70-002-FC	09140022762

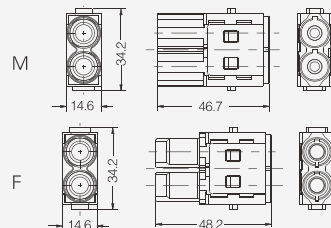

附件 Accessories

70A 冷压针 Crimp contacts

接触电阻  $\leq 0.5 m\Omega$   
Contact resistance  $\leq 0.5 m\Omega$   
镀银 silver plated



公 Male	订货号 Part Number	母 Female	订货号 Part Number
CKSM70-10	09320007104	CKSF70-10	09320007204
CKSM70-16	09320007105	CKSF70-16	09320007205
CKSM70-25	09320007106	CKSF70-25	09320007206

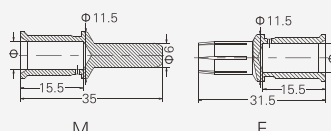

导线截面 Wire gauge	φ	剥线长度 Stripping length
10 mm <sup>2</sup>	4.3	15.5 mm
16mm <sup>2</sup>	5.5	15.5 mm
25 mm <sup>2</sup>	7	15.5 mm

电缆绞线依据 IEC 60 228-5  
for stranded wire according to IEC 60 228 Class 5

工具 Tools

液压钳  
Manual hydraulic clamp



压接线径 Wire gauge	型号 Type	订货号 Part Number
10-240mm <sup>2</sup>	TL05	09990000385

**Global District Limited**
**HMK-002 轴向压接型模块 Axial Module 1000V 40A**
**插芯 Inserts**

可与框架及其他所有模块产品组合使用

Combination with hinged frame and other modules possible.

**技术参数 Technical Characteristics**

规范	Specifications	
规范	Specifications	DIN EN 60 664
		DIN EN 61 984
插芯	Inserts	
接插件针数	Number Of Contacts	2
依据 EN 61 984 的电气数据	Electrical Data Acc. To EN 61 984	
-额定电流	-Rated Current	40A
-额定电压	-Rated Voltage	1000V
-额定脉冲电压	-Rated Impulse Voltage	8kV
-污染程度	-Pollution Degree	3
依据UL的额定电压	Rated Voltage Acc.to UI	600V
绝缘电阻	Insulation Resistance	$\geq 10^{10} \Omega$
材料	Material	聚碳酸酯 Polycarbonate
工作温度范围	Limiting Temperatures	-40°C...+125°C
依据UL 94的阻燃等级	Flammability Acc. To UI94	V0
可拔插次数	Mechanical Working Life-mating Cycles	$\geq 500$
插针	Contacts	
材料	Material	铜合金 Copper Alloy
表面处理	Surface	镀银 Hard-silver Plated
接触电阻	Contact Resistance	0.5m $\Omega$
电缆绞线依据IEC 60 228-5	To IEC 60 228 Class 5	
轴向螺栓连接	Axial Screw Terminal	
- mm <sup>2</sup>	-mm <sup>2</sup>	2.5-10mm <sup>2</sup>
- AWG	-AWG	14-8
- 内六角扳手	-Hexagonal Driver	SW 2
- 剥线长度	-Stripping length	
- mm <sup>2</sup>	- mm <sup>2</sup>	2.5 4 6 10
- mm	- mm	5 <sup>+1</sup> 5 <sup>+1</sup> 8 <sup>+1</sup> 11 <sup>+1</sup>
- 拧紧力矩	-Tightening Torque	
- mm <sup>2</sup>	- mm <sup>2</sup>	2.5 4 6 10
- Nm	- Nm	1.5 1.5 2 2

**电流负载能力 Current Carrying Capacity**

电流负载能力所受的限制主要来自包含接插针的接插体可承受的最大温度

测试和控制过程依据 DIN EN 60512-5

The current carrying is limited by maximum temperature of materials for Inserts and contacts including terminals.

Measuring and testing techniques according to DIN EN 60512-5

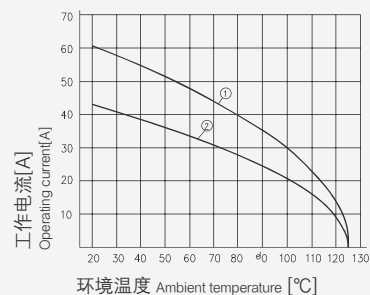

 ① 24B外壳带6个模块, 导线截面: 10mm<sup>2</sup>

 ② 24B外壳带6个模块, 导线截面: 6mm<sup>2</sup>

 ① 24 B hoods/housings with 6 modules, wire gauge:10mm<sup>2</sup>

 ② 24 B hoods/housings with 6 modules, wire gauge:6mm<sup>2</sup>
**轴向螺栓连接 Axial Screw Terminal**

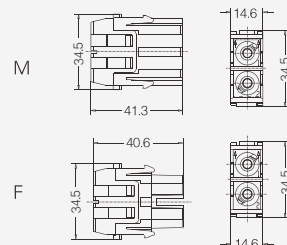
插芯 Inserts	型号 Type	订货号 Part Number
公 Male	HMK-002.1-M(2.5-8mm <sup>2</sup> )	09140022601
	HMK-002.2-M(6-10mm <sup>2</sup> )	09140022602
母 Female	HMK-002.1-F(2.5-8mm <sup>2</sup> )	09140022701
	HMK-002.2-F(6-10mm <sup>2</sup> )	09140022702

**附件 Accessories**
**工具 Tools**

 内六角扳手  
Hexagonal driver

描述 Description

 用于轴向夹紧螺栓  
带T型把手  
For Axial Setscrew  
With Grip

型号 Type

SW-2x40

订货号 Part Number

09990000313

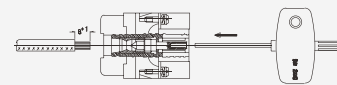



HMK-002 冷压型模块 Crimp Module 1000V 40A

插芯 Inserts



可与框架及其他所有模块产品组合使用  
Combination with hinged frame and other modules possible.

技术参数 Technical Characteristics

规范	Specifications	
规范	Specifications	DIN EN 60 664
		DIN EN 61 984
插芯	Inserts	
接插件针数	Number Of Contacts	2
依据 EN 61 984 的电气数据	Electrical Data Acc. To EN 61 984	
-额定电流	-Rated Current	40A
-额定电压	-Rated Voltage	1000V
-额定脉冲电压	-Rated Impulse Voltage	8kV
-污染程度	-Pollution Degree	3
绝缘电阻	Insulation Resistance	$\geq 10^{10}\Omega$
材料	Material	聚碳酸酯 Polycarbonate
工作温度范围	Limiting Temperatures	-40°C...+125°C
依据UL 94 的阻燃等级	Flammability Acc. To UI94	V0
可拔插次数	Mechanical Working Life-mating Cycles	$\geq 500$
插针	Contacts	
材料	Material	铜合金 Copper Alloy
表面处理	Surface	镀银 Hard-silver Plated
接触电阻	Contact Resistance	$\leq 0.3m\Omega$
冷压连接	Crimp Terminal	
- mm <sup>2</sup>	- mm <sup>2</sup>	1.5-10mm <sup>2</sup>
-AWG	-AWG	16-8

电流负载能力 Current Carrying Capacity

电流负载能力所受的限制主要来自包含接插针的接插体可承受的最大温度  
测试和控制过程依据 DIN EN 60512-5  
The current carrying is limited by maximum temperature of materials for Inserts and contacts including terminals.  
Measuring and testing techniques according to DIN EN 60512-5

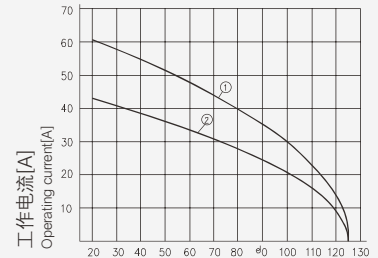

- ① 24B外壳带6个模块，导线截面：10mm<sup>2</sup>
- ② 24B外壳带6个模块，导线截面：6mm<sup>2</sup>
- ① 24 B hoods/housings with 6 modules, wire gauge:10mm<sup>2</sup>
- ② 24 B hoods/housings with 6 modules, wire gauge:6mm<sup>2</sup>

冷压连接 Crimp Terminal



插芯 Inserts	型号 Type	订货号 Part Number
公 Male	HMK-002-MC	09140023002
母 Female	HMK-002-FC	09140023102

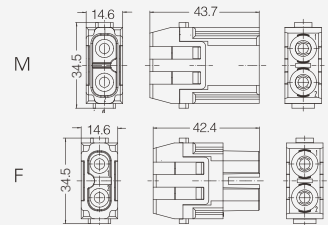

附件 Accessories

40A 冷压针 Crimp contacts

接触电阻  $\leq 0.3 m\Omega$   
Contact resistance  $\leq 0.3 m\Omega$   
镀银 silver plated



公 Male	订货号 Part Number	母 Female	订货号 Part Number
CCSM-1.5	09320006104	CCSF-1.5	09320006204
CCSM-2.5	09320006105	CCSF-2.5	09320006205
CCSM-4.0	09320006107	CCSF-4.0	09320006207
CCSM-6.0	09320006108	CCSF-6.0	09320006208
CCSM-10.0	09320006109	CCSF-10.0	09320006209

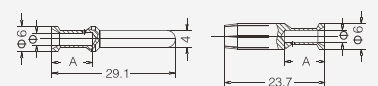

导线截面 Wire gauge	Φ	剥线长度 Stripping length
1.5 mm <sup>2</sup> AWG 16	1.75	9 mm
2.5 mm <sup>2</sup> AWG 14	2.25	9 mm
4 mm <sup>2</sup> AWG 12	2.85	9.6 mm
6 mm <sup>2</sup> AWG 10	3.5	9.6 mm
10 mm <sup>2</sup> AWG 8	4.3	15 mm

剥线长度 A=15 mm 用于电缆  $\geq 5$  mm  
剥线长度 A=18 mm 用于电缆  $\geq 6.4$  mm  
Stripping length A = 15 mm for cables  $\geq 5$  mm  
Stripping length A = 18 mm for cables  $\geq 6.4$  mm

工具 Tools

冷压钳  
Manual hydraulic clamp



压接线径 Wire gauge	型号 Type	订货号 Part Number
1.5-6mm <sup>2</sup>	TL02-0G	09990000110
4/6/10mm <sup>2</sup>	TL02-3G	09990000303

退针器  
Removal tool



适用类型 For	型号 Type	订货号 Part Number
40A 冷压针 Crimp contacts	TL06	09990000305



**Global District Limited**

**HMK-003 轴向压接型模块 Axial Module 690V 40A**

**插芯 Inserts**



可与框架及其他所有模块产品组合使用  
Combination with hinged frame and other modules possible.

**技术参数 Technical Characteristics**

规范	Specifications	
规范	Specifications	DIN EN 60 664
		DIN EN 61 984
插芯	Inserts	
接插件针数	Number Of Contacts	3
依据 EN 61 984 的电气数据	Electrical Data Acc. To EN 61 984	
- 额定电流	- Rated Current	40A
- 额定电压	- Rated Voltage	690V
- 额定脉冲电压	- Rated Impulse Voltage	8kV
- 污染程度	- Pollution Degree	3
依据 UL 的额定电压	Rated Voltage Acc.to UI	600V
绝缘电阻	Insulation Resistance	$\geq 10^{10} \Omega$
材料	Material	聚碳酸酯 Polycarbonate
工作温度范围	Limiting Temperatures	-40°C...+125°C
依据 UL 94 的阻燃等级	Flammability Acc. To UI94	V0
可拔插次数	Mechanical Working Life-mating Cycles	$\geq 500$
插针	Contacts	
材料	Material	铜合金 Copper Alloy
表面处理	Surface	镀银 Hard-silver Plated
接触电阻	Contact Resistance	0.3m $\Omega$
电缆绞线依据 IEC 60 228-5	To IEC 60 228 Class 5	
轴向螺栓连接	Axial Screw Terminal	
- mm <sup>2</sup>	- mm <sup>2</sup>	2.5-10mm <sup>2</sup>
- AWG	- AWG	14-8
- 内六角扳手	- Hexagonal Driver	SW 2
- 剥线长度	- Stripping length	
- mm <sup>2</sup>	- mm <sup>2</sup>	2.5 4 6 10
- mm	- mm	5 <sup>+1</sup> 5 <sup>+1</sup> 8 <sup>+1</sup> 11 <sup>+1</sup>
- 拧紧力矩	- Tightening Torque	
- mm <sup>2</sup>	- mm <sup>2</sup>	2.5 4 6 10
- Nm	- Nm	1.5 1.5 2 2

**电流负载能力 Current Carrying Capacity**

电流负载能力所受的限制主要来自包含接插针的接插体可承受的最大温度  
测试和控制过程依据 DIN EN 60512-5  
The current carrying is limited by maximum temperature of materials for Inserts and contacts including terminals.  
Measuring and testing techniques according to DIN EN 60512-5

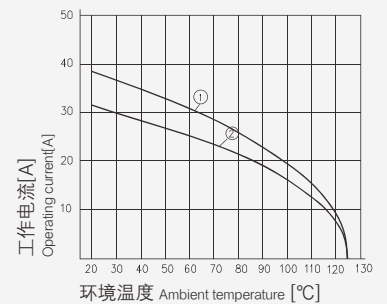

- ① 24B外壳带6个模块，导线截面：6mm<sup>2</sup>
- ② 24B外壳带6个模块，导线截面：4mm<sup>2</sup>
- ① 24 B hoods/housings with 6 modules, wire gauge:6mm<sup>2</sup>
- ② 24 B hoods/housings with 6 modules, wire gauge:4mm<sup>2</sup>

**轴向螺栓连接 Axial Screw Terminal**



插芯 Inserts	型号 Type	订货号 Part Number
公 Male	HMK-003.1-M(2.5-8mm <sup>2</sup> )	09140032601
	HMK-003.2-M(6-10mm <sup>2</sup> )	09140032602
母 Female	HMK-003.1-F(2.5-8mm <sup>2</sup> )	09140032701
	HMK-003.2-F(6-10mm <sup>2</sup> )	09140032702

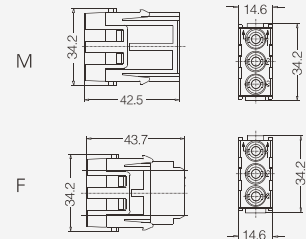

**附件 Accessories**

**工具 Tools**

内六角扳手  
Hexagonal driver



描述 Description	型号 Type	订货号 Part Number
用于轴向夹紧螺栓 带T型把手 For Axial Setscrew With Grip	SW-2x40	09990000313

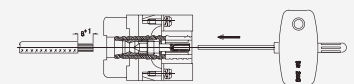



HMK-003 冷压型模块 Crimp Module 400/690V 40A

插芯 Inserts



可与框架及其他所有模块产品组合使用  
Combination with hinged frame and other modules possible.

技术参数 Technical Characteristics

规范	Specifications	
规范	Specifications	DIN EN 60 664 DIN EN 61 984
插芯	Inserts	
接插件针数	Number Of Contacts	3
依据 EN 61 984 的电气数据	Electrical Data Acc. To EN 61 984	
-额定电流	-Rated Current	40A
-额定电压	-Rated Voltage	500V
-额定脉冲电压	-Rated Impulse Voltage	6kV
-污染程度	-Pollution Degree	3
依据UL/CSA的额定电压	Rated Voltage Acc. to UL/CSA	600V
依据UL/CSA的额定电流	Rated Current Acc. to UL/CSA	32A
绝缘电阻	Insulation Resistance	$\geq 10^{10} \Omega$
材料	Material	聚碳酸酯 Polycarbonate
工作温度范围	Limiting Temperatures	-40°C...+125°C
依据UL 94的阻燃等级	Flammability Acc. To UI94	V0
可拔插次数	Mechanical Working Life-mating Cycles	$\geq 500$
插针	Contacts	
材料	Material	铜合金 Copper Alloy
表面处理	Surface	镀银 Hard-silver Plated
接触电阻	Contact Resistance	$\leq 0.3m\Omega$
冷压连接	Crimp Terminal	
- mm <sup>2</sup>	- mm <sup>2</sup>	1.5-10mm <sup>2</sup>
-AWG	-AWG	16-8

电流负载能力 Current Carrying Capacity

电流负载能力所受的限制主要来自包含接插针的接插体可承受的最大温度  
测试和控制过程依据 DIN EN 60512-5  
The current carrying is limited by maximum temperature of materials for Inserts and contacts including terminals.  
Measuring and testing techniques according to DIN EN 60512-5

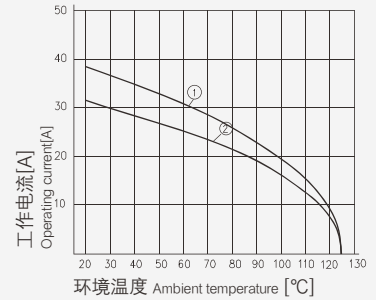

- ① 24B外壳带6个模块，导线截面：6mm<sup>2</sup>
- ② 24B外壳带6个模块，导线截面：4mm<sup>2</sup>
- ① 24 B hoods/housings with 6 modules, wire gauge:6mm<sup>2</sup>
- ② 24 B hoods/housings with 6 modules, wire gauge:4mm<sup>2</sup>

冷压连接 Crimp Terminal



插芯 Inserts	型号 Type	订货号 Part Number
公 Male	HMK-003-MC	09140033003
母 Female	HMK-003-FC	09140033103

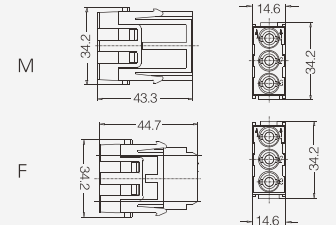

附件 Accessories

40A 冷压针 Crimp contacts

接触电阻  $\leq 0.3 m\Omega$   
Contact resistance  $\leq 0.3 m\Omega$   
镀银 silver plated



公 Male	订货号 Part Number	母 Female	订货号 Part Number
CCSM-1.5	09320006104	CCSF-1.5	09320006204
CCSM-2.5	09320006105	CCSF-2.5	09320006205
CCSM-4.0	09320006107	CCSF-4.0	09320006207
CCSM-6.0	09320006108	CCSF-6.0	09320006208
CCSM-10.0	09320006109	CCSF-10.0	09320006209

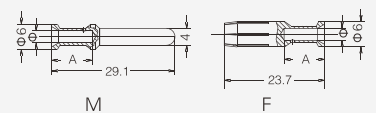

导线截面 Wire gauge	Φ	剥线长度 Stripping length
1.5 mm <sup>2</sup> AWG 16	1.75	9 mm
2.5mm <sup>2</sup> AWG 14	2.25	9 mm
4 mm <sup>2</sup> AWG 12	2.85	9.6 mm
6 mm <sup>2</sup> AWG 10	3.5	9.6 mm
10 mm <sup>2</sup> AWG 8	4.3	15 mm

剥线长度 A=15 mm 用于电缆  $\geq 5$  mm  
剥线长度 A=18 mm 用于电缆  $\geq 6.4$  mm  
Stripping length A = 15 mm for cables  $\geq 5$  mm  
Stripping length A = 18 mm for cables  $\geq 6.4$  mm

工具 Tools



压接线经 Wire gauge	型号 Type	订货号 Part Number
1.5-6mm <sup>2</sup>	TL02-0G	09990000110
4/6/10mm <sup>2</sup>	TL02-3G	09990000303



适用类型 For	型号 Type	订货号 Part Number
40A 冷压针 Crimp contacts	TL06	09990000305





Global District Limited

HMK-003/4 冷压型模块 Crimp Module 830/830V 40/10A

插芯 Inserts



可与框架及其他所有模块产品组合使用  
Combination with hinged frame and other modules possible.

技术参数 Technical Characteristics

规范	Specifications	DIN EN 60 664
规范	Specifications	DIN EN 61 984
插芯	Inserts	
接插件针数	Number Of Contacts	3/4
依据 EN 61 984 的电气数据	Electrical Data Acc. To EN 61 984	
电力区	Power Contacts	
-额定电流	-Rated Current	40A
-额定电压	-Rated Voltage	830V
-额定脉冲电压	-Rated Impulse Voltage	8kV
-污染程度	-Pollution Degree	3
信号区	Signal Contacts	
-额定电流	-Rated Current	10A
-额定电压	-Rated Voltage	830V
-额定脉冲电压	-Rated Impulse Voltage	8kV
-污染程度	-Pollution Degree	3
依据UL的额定电压	Rated Voltage Acc.to UI	600V
绝缘电阻	Insulation Resistance	$\geq 10^{10} \Omega$
材料	Material	聚碳酸酯 Polycarbonate
工作温度范围	Limiting Temperatures	-40°C...+125°C
依据UL 94的阻燃等级	Flammability Acc. To UI94	V0
可拔插次数	Mechanical Working Life-mating Cycles	$\geq 500$
插针	Contacts	
材料	Material	铜合金 Copper Alloy
表面处理	Surface	镀银 Hard-silver Plated 镀金 Hard-gold Plated
接触电阻	Contact Resistance	
-电力区	Power Contacts	$\leq 0.3m\Omega$
-信号区	Signal Contacts	$\leq 3m\Omega$
冷压连接	Crimp terminal	
- mm <sup>2</sup>	mm <sup>2</sup>	
-电力区	Power Contacts	1.5-6mm <sup>2</sup>
-信号区	Signal Contacts	0.14-2.5mm <sup>2</sup>
- AWG	AWG	
-电力区	Power Contacts	16-10
-信号区	Signal Contacts	26-14
最大电缆直径	Max. insulation diameter	
-电力区	Power Contacts	5mm

电流负载能力 Current Carrying Capacity

电流负载能力所受的限制主要来自包含接插针的接插体可承受的最大温度  
测试和控制过程依据 DIN EN 60512-5  
The current carrying is limited by maximum temperature of materials for Inserts and contacts including terminals.  
Measuring and testing techniques according to DIN EN 60512-5

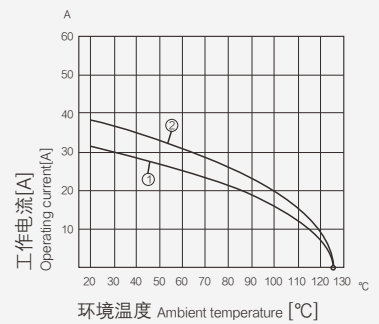

- ① 24B外壳带6个模块，导线截面：4mm<sup>2</sup>
- ② 24B外壳带6个模块，导线截面：6mm<sup>2</sup>
- ① 24 B hoods/housings with 6 modules, wire gauge:4mm<sup>2</sup>
- ② 24 B hoods/housings with 6 modules, wire gauge:6mm<sup>2</sup>

冷压连接 Crimp Terminal



插芯 Inserts	型号 Type	订货号 Part Number
公 Male	HMK-003/4-MC	09140073001
母 Female	HMK-003/4-FC	09140073101

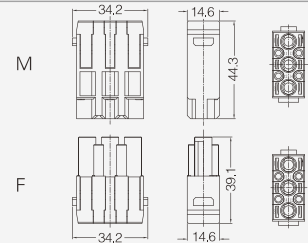

附件 Accessories

40A/10A 冷压针 Crimp contacts

接触电阻  $\leq 0.3 m\Omega$   
Contact resistance  $\leq 0.3 m\Omega$   
镀银 silver plated



公 Male	订货号 Part Number	母 Female	订货号 Part Number
CCSM-1.5	09320006104	CCSF-1.5	09320006204
CCSM-2.5	09320006105	CCSF-2.5	09320006205
CCSM-4.0	09320006107	CCSF-4.0	09320006207
CCSM-6.0	09320006108	CCSF-6.0	09320006208
CCSM-10.0	09320006109	CCSF-10.0	09320006209

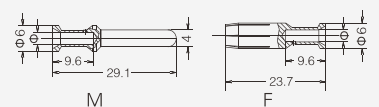

线规 Wire gauge	Φ	剥线长度 Stripping length
1.5 mm <sup>2</sup>	AWG 16	1.75 9 mm
2.5mm <sup>2</sup>	AWG 14	2.25 9 mm
4 mm <sup>2</sup>	AWG 12	2.85 9.6 mm
6 mm <sup>2</sup>	AWG 10	3.5 9.6 mm



Global District Limited

HMK-004 冷压型模块 Crimp Module 830V 40A

插芯 Inserts



可与框架及其他所有模块产品组合使用

Combination with hinged frame and other modules possible.

技术参数 Technical Characteristics

规范	Specifications	
规范	Specifications	DIN EN 60 664
		DIN EN 61 984
插芯	Inserts	
接插件针数	Number Of Contacts	4
依据 EN 61 984 的电气数据	Electrical Data Acc. To EN 61 984	
-额定电流	-Rated Current	40A
-额定电压	-Rated Voltage	830V
-额定脉冲电压	-Rated Impulse Voltage	8kV
-污染程度	-Pollution Degree	3
依据UL的额定电压	Rated Voltage Acc. to UL	600V
绝缘电阻	Insulation Resistance	$\geq 10^{10} \Omega$
材料	Material	聚碳酸酯 Polycarbonate
工作温度范围	Limiting Temperatures	-40°C...+125°C
依据UL 94的阻燃等级	Flammability Acc. To UI94	V0
可拔插次数	Mechanical Working Life-mating Cycles	$\geq 500$
插针	Contacts	
材料	Material	铜合金 Copper Alloy
表面处理	Surface	镀银 Hard-silver Plated
接触电阻	Contact Resistance	$\leq 0.3m\Omega$
冷压连接	Crimp Terminal	
- mm <sup>2</sup>	- mm <sup>2</sup>	1.5-6mm <sup>2</sup>
-AWG	-AWG	16-10

电流负载能力 Current Carrying Capacity

电流负载能力所受的限制主要来自包含接插针的接插体可承受的最大温度

测试和控制过程依据 DIN EN 60512-5

The current carrying is limited by maximum temperature of materials for Inserts and contacts including terminals. Measuring and testing techniques according to DIN EN 60512-5

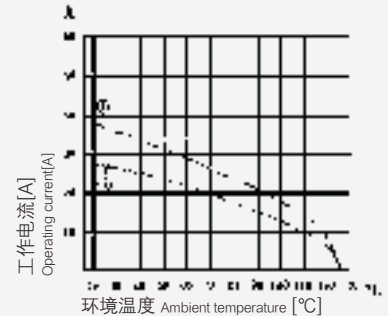

- ① 24B外壳带6个模块，导线截面：4mm<sup>2</sup>
- ② 24B外壳带6个模块，导线截面：6mm<sup>2</sup>
- ① 24 B hoods/housings with 6 modules, wire gauge:4mm<sup>2</sup>
- ② 24 B hoods/housings with 6 modules, wire gauge:6mm<sup>2</sup>

冷压连接 Crimp Terminal

	插芯 Inserts	型号 Type	订货号 Part Number
	公 Male	HMK-004-MC	09140043041
	母 Female	HMK-004-FC	09140043141

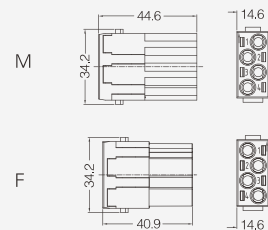

附件 Accessories

40A 冷压针 Crimp contacts

接触电阻 Contact resistance  $\leq 0.3m\Omega$   
镀银 Silver plated



公 Male	订货号 Part Number	母 Female	订货号 Part Number
CCSM-1.5	09320006104	CCSF-1.5	09320006204
CCSM-2.5	09320006105	CCSF-2.5	09320006205
CCSM-4.0	09320006107	CCSF-4.0	09320006207
CCSM-6.0	09320006108	CCSF-6.0	09320006208

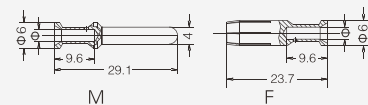

线规 Wire gauge	Φ	剥线长度 Stripping length
1.5 mm <sup>2</sup> AWG 16	1.75	9 mm
2.5 mm <sup>2</sup> AWG 14	2.25	9 mm
4 mm <sup>2</sup> AWG 12	2.85	9.6 mm
6 mm <sup>2</sup> AWG 10	3.5	9.6 mm

工具 Tools

冷压钳 Manual hydraulic clamp	压接线径 Wire gauge 1.5-6mm <sup>2</sup>	型号 Type TL02-0G	订货号 Part Number 09990000110
-------------------------------	---	--------------------	--------------------------------



退针器 Removal tool	适用类型 For 40A 冷压针 Crimp contacts	型号 Type TL06	订货号 Part Number 09990000305
---------------------	------------------------------------	-----------------	--------------------------------





Global District Limited

HME-005 弹片型模块 Cage-clamp Module 400V 16A

## 插芯 Inserts



可与框架及其他所有模块产品组合使用

Combination with hinged frame and other modules possible.

## 技术参数 Technical Characteristics

规范	Specifications	
规范	Specifications	DIN EN 60 664
		DIN EN 61 984
插芯	Inserts	
接插件针数	Number Of Contacts	5
依据 EN 61 984 的电气数据	Electrical Data Acc. To EN 61 984	
- 工作电流	- Rated Current	16A
- 工作电压	- Rated Voltage	400V
- 额定脉冲电压	- Rated Impulse Voltage	6kV
- 污染程度	- Pollution Degree	3
依据 UL 的额定电压	Rated Voltage Acc. to UL	600V
绝缘电阻	Insulation Resistance	$\geq 10^{10} \Omega$
材料	Material	聚碳酸酯 Polycarbonate
工作温度范围	Limiting Temperatures	-40°C...+125°C
依据 UL 94 的阻燃等级	Flammability Acc. to UL94	V0
可拔插次数	Mechanical Working Life-mating Cycles	$\geq 500$
插针	Contacts	
材料	Material	铜合金 Copper Alloy
表面处理	Surface	镀银 Hard-silver Plated
接触电阻	Contact Resistance	$\leq 3m\Omega$
弹片连接	Cage Clamp Terminal	
- mm <sup>2</sup>	- mm <sup>2</sup>	0.14-2.5mm <sup>2</sup>
- AWG	- AWG	26-14

## 电流负载能力 Current Carrying Capacity

电流负载能力所受的限制主要来自包含插针的接插体可承受的最大温度

测试和控制过程依据 DIN EN 60512-5

The current carrying is limited by maximum temperature of materials for inserts and contacts including terminals.

Measuring and testing techniques according to DIN EN 60512-5

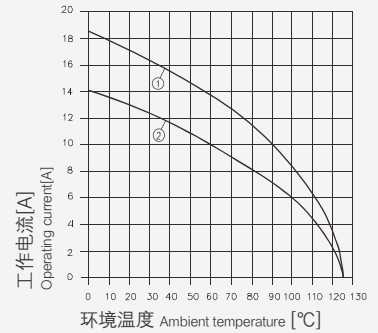
① 24 B外壳带6个模块, 导线截面:2.5mm<sup>2</sup>② 24 B外壳带6个模块, 导线截面:1.5mm<sup>2</sup>① 24 B hoods/housings with 6 modules, wire gauge:2.5mm<sup>2</sup>② 24 B hoods/housings with 6 modules, wire gauge:1.5mm<sup>2</sup>

## 冷压连接 Crimp Terminal



插芯 Inserts	型号 Type	订货号 Part Number
公 Male	HME-005-MS	09140052616
母 Female	HME-005-FS	09140052716

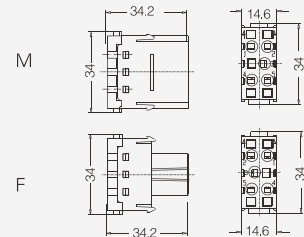



HME-006 冷压型模块 Crimp Module 500V 16A

插芯 Inserts



可与框架及其他所有模块产品组合使用  
Combination with hinged frame and other modules possible.

技术参数 Technical Characteristics

规范	Specifications	
规范	Specifications	DIN EN 60 664 DIN EN 61 984
插芯	Inserts	
接插件针数	Number Of Contacts	6
依据 EN 61 984 的电气数据	Electrical Data Acc. To EN 61 984	
-工作电流	-Rated Current	16A
-工作电压	-Rated Voltage	500V
-额定脉冲电压	-Rated Impulse Voltage	6kV
-污染程度	-Pollution Degree	3
依据UL/CSA的额定电压	Rated Voltage Acc. to UL/CSA	600V
绝缘电阻	Insulation Resistance	$\geq 10^{10} \Omega$
材料	Material	聚碳酸酯 Polycarbonate
工作温度范围	Limiting Temperatures	-40°C...+125°C
依据UL 94的阻燃等级	Flammability Acc. to UL94	V0
可拔插次数	Mechanical Working Life-mating Cycles	$\geq 500$
插针	Contacts	
材料	Material	铜合金 Copper Alloy
表面处理	Surface	镀银 Hard-silver Plated 镀金 Hard-gold Plated
接触电阻	Contact Resistance	$\leq 1m\Omega$
冷压连接	Cage Clamp Terminal	
- mm <sup>2</sup>	- mm <sup>2</sup>	0.14-4mm <sup>2</sup>
-AWG	-AWG	26-12

电流负载能力 Current Carrying Capacity

电流负载能力所受的限制主要来自包含接插针的接插体可承受的最大温度  
测试和控制过程依据 DIN EN 60512-5  
The current carrying is limited by maximum temperature of materials for Inserts and contacts including terminals.  
Measuring and testing techniques according to DIN EN 60512-5

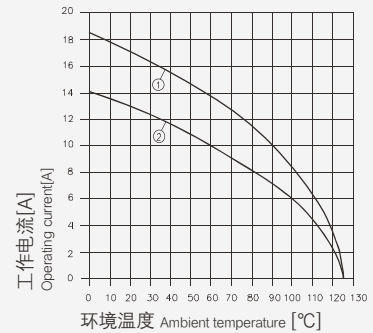

- ① 24 B外壳带6个模块，导线截面:2.5mm<sup>2</sup>
- ② 24 B外壳带6个模块，导线截面:1.5mm<sup>2</sup>
- ① 24 B hoods/housings with 6 modules, wire gauge:2.5mm<sup>2</sup>
- ② 24 B hoods/housings with 6 modules, wire gauge:1.5mm<sup>2</sup>

冷压连接 Crimp Terminal



插芯 Inserts	型号 Type	订货号 Part Number
公 Male	HME-006-MC	09140063001
母 Female	HME-006-FC	09140063101

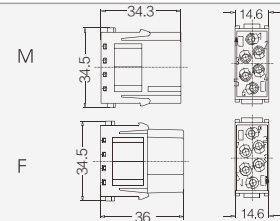

附件 Accessories

16A 冷压针 Crimp contacts

接触电阻 Contact resistance $\leq 1m\Omega$	公 Male	订货号 Part Number	母 Female	订货号 Part Number
镀银 Silver plated	CESM-0.37	09330006127	CESF-0.37	09330006227
	CESM-0.5	09330006121	CESF-0.5	09330006220
	CESM-0.75	09330006114	CESF-0.75	09330006214
	CESM-1.0	09330006105	CESF-1.0	09330006205
	CESM-1.5	09330006104	CESF-1.5	09330006204
	CESM-2.5	09330006102	CESF-2.5	09330006202
	CESM-3.0	09330006106	CESF-3.0	09330006206
	CESM-4.0	09330006107	CESF-4.0	09330006207
镀金 Gold plated	CEGM-0.37	09330006117	CEGF-0.37	09330006217
	CEGM-0.5	09330006122	CEGF-0.5	09330006222
	CEGM-0.75	09330006115	CEGF-0.75	09330006215
	CEGM-1.0	09330006118	CEGF-1.0	09330006218
	CEGM-1.5	09330006116	CEGF-1.5	09330006216
	CEGM-2.5	09330006123	CEGF-2.5	09330006223
	CEGM-4.0	09330006119	CEGF-4.0	09330006221

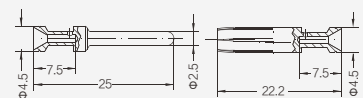

标识 Identification	线规 Wire gauge	剥线长度 Stripping length
no groove	0.14-0.37mm <sup>2</sup>	AWG 26-22
no groove	0.5mm <sup>2</sup>	AWG 20
1 groove	0.75mm <sup>2</sup>	AWG 18
1 groove	1mm <sup>2</sup>	AWG 18
2 groove	1.5mm <sup>2</sup>	AWG 16
3 groove	2.5mm <sup>2</sup>	AWG 14
wide groove	3mm <sup>2</sup>	AWG 12
no groove	4mm <sup>2</sup>	AWG 12

工具 Tools

冷压钳 Crimping tool	压接线径 Wire gauge	型号 Type	订货号 Part Number
	0.5-4mm <sup>2</sup>	TL02G	09990000021
退针器 Removal tool	压接线径: 0.14-0.37mm <sup>2</sup> 请选择TL02冷压钳 Wire gauge: 0.14-0.37mm <sup>2</sup> please select TL02 Crimping tool	适用类型 For	型号 Type
	16A 冷压针 Crimp contacts	TL01	09990000059



**HVME-006 防护型模块 Protected Module 830V 16A**

**插芯 Inserts**



可与框架及其他所有模块产品组合使用  
Combination with hinged frame and other modules possible.

**技术参数 Technical Characteristics**

规范	Specifications	
规范	Specifications	DIN EN 60 664
		DIN EN 61 984
插芯	Inserts	
接插件针数	Number Of Contacts	6
依据 EN 61 984 的电气数据	Electrical Data Acc. To EN 61 984	
- 工作电流	- Rated Current	16A
- 工作电压	- Rated Voltage	830V
- 额定脉冲电压	- Rated Impulse Voltage	8kV
- 污染程度	- Pollution Degree	3
依据 UL/CSA 的额定电压	Rated Voltage Acc. to UL/CSA	600V
绝缘电阻	Insulation Resistance	≥ 10 <sup>10</sup> Ω
材料	Material	聚碳酸酯 Polycarbonate
工作温度范围	Limiting Temperatures	-40°C...+125°C
依据 UL 94 的阻燃等级	Flammability Acc. to UL94	V0
可拔插次数	Mechanical Working Life-mating Cycles	≥ 500
插针	Contacts	
材料	Material	铜合金 Copper Alloy
表面处理	Surface	镀银 Hard-silver Plated 镀金 Hard-gold Plated
接触电阻	Contact Resistance	≤ 1mΩ
冷压连接	Cage Clamp Terminal	
- mm <sup>2</sup>	- mm <sup>2</sup>	0.14-4mm <sup>2</sup>
- AWG	- AWG	26-12

**电流负载能力 Current Carrying Capacity**

电流负载能力所受的限制主要来自包含接插针的接插体可承受的最大温度  
测试和控制过程依据 DIN EN 60512-5  
The current carrying is limited by maximum temperature of materials for inserts and contacts including terminals.  
Measuring and testing techniques according to DIN EN 60512-5

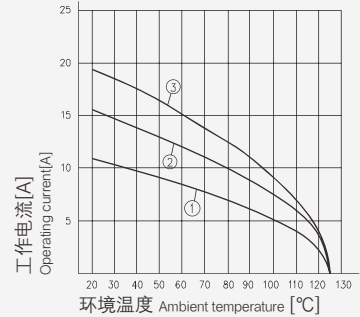

**冷压连接 Crimp Terminal**



插芯 Inserts	型号 Type	订货号 Part Number
公 Male	HVME-006-MC	09140063041
母 Female	HVME-006-FC	09140063141

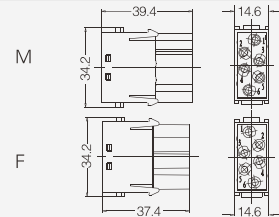

**附件 Accessories**

**16A 冷压针 Crimp contacts**

接触电阻 Contact resistance ≤ 1mΩ  
镀银 Silver plated



镀金 Gold plated



公 Male	订货号 Part Number	母 Female	订货号 Part Number
CESM-0.37	09330006127	CESF-0.37	09330006227
CESM-0.5	09330006121	CESF-0.5	09330006220
CESM-0.75	09330006114	CESF-0.75	09330006214
CESM-1.0	09330006105	CESF-1.0	09330006205
CESM-1.5	09330006104	CESF-1.5	09330006204
CESM-2.5	09330006102	CESF-2.5	09330006202
CESM-3.0	09330006106	CESF-3.0	09330006206
CESM-4.0	09330006107	CESF-4.0	09330006207
CEGM-0.37	09330006117	CEGF-0.37	09330006217
CEGM-0.5	09330006122	CEGF-0.5	09330006222
CEGM-0.75	09330006115	CEGF-0.75	09330006215
CEGM-1.0	09330006118	CEGF-1.0	09330006218
CEGM-1.5	09330006116	CEGF-1.5	09330006216
CEGM-2.5	09330006123	CEGF-2.5	09330006223
CEGM-4.0	09330006119	CEGF-4.0	09330006221

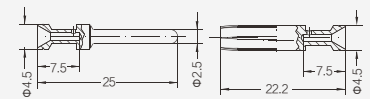

标示 Identification	线规 Wire gauge	剥线长度 Stripping length
no groove	014-0.37mm <sup>2</sup> AWG 26-22	7.5mm
no groove	0.5mm <sup>2</sup> AWG 20	7.5mm
1 groove	0.75mm <sup>2</sup> AWG 18	7.5mm
1 groove	1mm <sup>2</sup> AWG 18	7.5mm
2 groove	1.5mm <sup>2</sup> AWG 16	7.5mm
3 groove	2.5mm <sup>2</sup> AWG 14	7.5mm
wide groove	3mm <sup>2</sup> AWG 12	7.5mm
no groove	4mm <sup>2</sup> AWG 12	7.5mm

**工具 Tools**

冷压钳  
Crimping tool



压接线径 Wire gauge 型号 Type 订货号 Part Number  
0.5-4mm<sup>2</sup> TL02G 09990000021

退针器  
Removal tool



压接线径: 0.14-0.37mm<sup>2</sup>请选择TL02冷压钳  
Wire gauge: 0.14-0.37mm<sup>2</sup> please select TL02 Crimping tool  
适用类型 For 型号 Type 订货号 Part Number  
16A 冷压针 Crimp contacts TL01 09990000059



HMEE-008 冷压型模块 Crimp Module 400V 16A

插芯 Inserts



可与框架及其他所有模块产品组合使用  
Combination with hinged frame and other modules possible.

技术参数 Technical Characteristics

规范	Specifications	
规范	Specifications	DIN EN 60 664 DIN EN 61 984
插芯	Inserts	
接插件针数	Number Of Contacts	8
依据 EN 61 984 的电气数据	Electrical Data Acc. To EN 61 984	
-工作电流	-Rated Current	16A
-工作电压	-Rated Voltage	400V
-额定脉冲电压	-Rated Impulse Voltage	6kV
-污染程度	-Pollution Degree	3
依据UL/CSA的额定电压	Rated Voltage Acc. to UL/CSA	600V
绝缘电阻	Insulation Resistance	$\geq 10^{10} \Omega$
材料	Material	聚碳酸酯 Polycarbonate
工作温度范围	Limiting Temperatures	-40°C...+125°C
依据UL 94的阻燃等级	Flammability Acc. to UL94	V0
可拔插次数	Mechanical Working Life-mating Cycles	$\geq 500$
插针	Contacts	
材料	Material	铜合金 Copper Alloy
表面处理	Surface	镀银 Hard-silver Plated 镀金 Hard-gold Plated
接触电阻	Contact Resistance	$\leq 1m\Omega$
冷压连接	Cage Clamp Terminal	
- mm <sup>2</sup>	- mm <sup>2</sup>	0.14-4mm <sup>2</sup>
-AWG	-AWG	26-12

电流负载能力 Current Carrying Capacity

电流负载能力所受的限制主要来自包含接插针的接插体可承受的最大温度  
测试和控制过程依据 DIN EN 60512-5  
The current carrying is limited by maximum temperature of materials for Inserts and contacts including terminals.  
Measuring and testing techniques according to DIN EN 60512-5

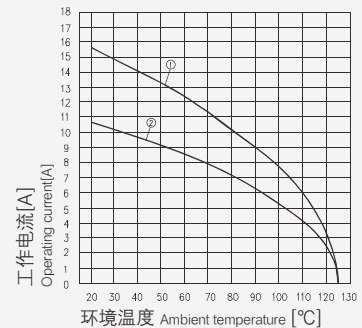

- ① 24 B外壳带6个模块, 导线截面:2.5mm<sup>2</sup>
- ② 24 B外壳带6个模块, 导线截面:1.5mm<sup>2</sup>
- ① 24 B hoods/housings with 6 modules, wire gauge:2.5mm<sup>2</sup>
- ② 24 B hoods/housings with 6 modules, wire gauge:1.5mm<sup>2</sup>

冷压连接 Crimp Terminal



插芯 Inserts	型号 Type	订货号 Part Number
公 Male	HMEE-008-MC	09140083001
母 Female	HMEE-008-FC	09140083101

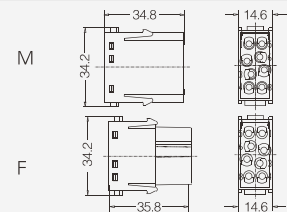

附件 Accessories

16A 冷压针 Crimp contacts

接触电阻 Contact resistance $\leq 1m\Omega$ 镀银 Silver plated	公 Male	订货号 Part Number	母 Female	订货号 Part Number
	CESM-0.37	09330006127	CESF-0.37	09330006227
	CESM-0.5	09330006121	CESF-0.5	09330006220
	CESM-0.75	09330006114	CESF-0.75	09330006214
	CESM-1.0	09330006105	CESF-1.0	09330006205
	CESM-1.5	09330006104	CESF-1.5	09330006204
	CESM-2.5	09330006102	CESF-2.5	09330006202
	CESM-3.0	09330006106	CESF-3.0	09330006206
	CESM-4.0	09330006107	CESF-4.0	09330006207
	镀金 Gold plated	公 Male	订货号 Part Number	母 Female
CEGM-0.37		09330006117	CEGF-0.37	09330006217
CEGM-0.5		09330006122	CEGF-0.5	09330006222
CEGM-0.75		09330006115	CEGF-0.75	09330006215
CEGM-1.0		09330006118	CEGF-1.0	09330006218
CEGM-1.5		09330006116	CEGF-1.5	09330006216
CEGM-2.5		09330006123	CEGF-2.5	09330006223
CEGM-4.0		09330006119	CEGF-4.0	09330006221

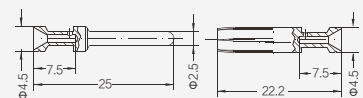

标示 Identification	线规 Wire gauge	剥线长度 Stripping length	
no groove	0.14-0.37mm <sup>2</sup>	AWG 26-22	7.5mm
no groove	0.5mm <sup>2</sup>	AWG 20	7.5mm
1 groove	0.75mm <sup>2</sup>	AWG 18	7.5mm
1 groove	1mm <sup>2</sup>	AWG 18	7.5mm
2 groove	1.5mm <sup>2</sup>	AWG 16	7.5mm
3 groove	2.5mm <sup>2</sup>	AWG 14	7.5mm
wide groove	3mm <sup>2</sup>	AWG 12	7.5mm
no groove	4mm <sup>2</sup>	AWG 12	7.5mm

工具 Tools

冷压钳 Crimping tool	压接线径 Wire gauge	型号 Type	订货号 Part Number
	0.5-4mm <sup>2</sup>	TL02G	09990000021
	压接线径: 0.14-0.37mm <sup>2</sup> 请选择TL02冷压钳 Wire gauge: 0.14-0.37mm <sup>2</sup> please select TL02 Crimping tool		
退针器 Removal tool	适用类型 For	型号 Type	订货号 Part Number
	16A 冷压针 Crimp contacts	TL01	09990000059



H2MEE-020 冷压型模块 Crimp Module 500V 16A

插芯 Inserts



可与框架及其他所有模块产品组合使用  
Combination with hinged frame and other modules possible.

技术参数 Technical Characteristics

规范	Specifications	
规范	Specifications	DIN EN 60 664
		DIN EN 61 984
插芯	Inserts	
接插件针数	Number Of Contacts	20
依据 EN 61 984 的电气数据	Electrical Data Acc. To EN 61 984	
-工作电流	-Rated Current	16A
-工作电压	-Rated Voltage	500V
-额定脉冲电压	-Rated Impulse Voltage	6kV
-污染程度	-Pollution Degree	3
依据UL/CSA的额定电压	Rated Voltage Acc. to UL/CSA	600V
绝缘电阻	Insulation Resistance	≥ 10 <sup>10</sup> Ω
材料	Material	聚碳酸酯 Polycarbonate
工作温度范围	Limiting Temperatures	-40°C...+125°C
依据UL 94的阻燃等级	Flammability Acc. to UL94	V0
可拔插次数	Mechanical Working Life-mating Cycles	≥ 500
插针	Contacts	
材料	Material	铜合金 Copper Alloy
表面处理	Surface	镀银 Hard-silver Plated 镀金 Hard-gold Plated
接触电阻	Contact Resistance	≤ 1m Ω
冷压连接	Cage Clamp Terminal	
- mm <sup>2</sup>	- mm <sup>2</sup>	0.14-4mm <sup>2</sup>
-AWG	-AWG	26-12

电流负载能力 Current Carrying Capacity

电流负载能力所受的限制主要来自包含接插针的接插体可承受的最大温度  
测试和控制过程依据 DIN EN 60512-5  
The current carrying is limited by maximum temperature of materials for inserts and contacts including terminals.  
Measuring and testing techniques according to DIN EN 60512-5

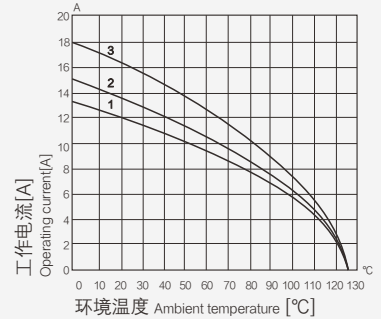

- ① 24 B外壳带3个模块, 导线截面:1.5mm<sup>2</sup>
- ② 24 B外壳带3个模块, 导线截面:2.5mm<sup>2</sup>
- ③ 24 B外壳带3个模块, 导线截面:4.0mm<sup>2</sup>
- ① 24 B hoods/housings with 3 modules, wire gauge:1.5mm<sup>2</sup>
- ② 24 B hoods/housings with 3 modules, wire gauge:2.5mm<sup>2</sup>
- ③ 24 B hoods/housings with 3 modules, wire gauge:4.0mm<sup>2</sup>

冷压连接 Crimp Terminal



插芯 Inserts	型号 Type	订货号 Part Number
公 Male	H2MEE-020-MC	09140203001
母 Female	H2MEE-020-FC	09140203101

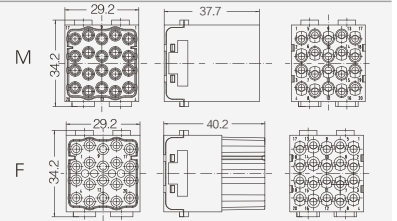

附件 Accessories

16A 冷压针 Crimp contacts

接触电阻 Contact resistance ≤ 1m Ω  
镀银 Silver plated



镀金 Gold plated



公 Male	订货号 Part Number	母 Female	订货号 Part Number
CESM-0.37	09330006127	CESF-0.37	09330006227
CESM-0.5	09330006121	CESF-0.5	09330006220
CESM-0.75	09330006114	CESF-0.75	09330006214
CESM-1.0	09330006105	CESF-1.0	09330006205
CESM-1.5	09330006104	CESF-1.5	09330006204
CESM-2.5	09330006102	CESF-2.5	09330006202
CESM-3.0	09330006106	CESF-3.0	09330006206
CESM-4.0	09330006107	CESF-4.0	09330006207
CEGM-0.37	09330006117	CEGF-0.37	09330006217
CEGM-0.5	09330006122	CEGF-0.5	09330006222
CEGM-0.75	09330006115	CEGF-0.75	09330006215
CEGM-1.0	09330006118	CEGF-1.0	09330006218
CEGM-1.5	09330006116	CEGF-1.5	09330006216
CEGM-2.5	09330006123	CEGF-2.5	09330006223
CEGM-4.0	09330006119	CEGF-4.0	09330006221

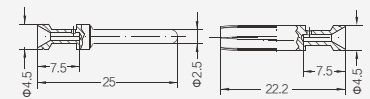

标示 Identification	线规 Wire gauge	剥线长度 Stripping length
no groove	014-0.37mm <sup>2</sup>	AWG 26-22
no groove	0.5mm <sup>2</sup>	AWG 20
1 groove	0.75mm <sup>2</sup>	AWG 18
1 groove	1.1mm <sup>2</sup>	AWG 18
2 groove	1.5mm <sup>2</sup>	AWG 16
3 groove	2.5mm <sup>2</sup>	AWG 14
wide groove	3mm <sup>2</sup>	AWG 12
no groove	4mm <sup>2</sup>	AWG 12

工具 Tools

冷压钳  
Crimping tool



压接线径 Wire gauge 0.5-4mm<sup>2</sup> 型号 Type TL02G 订货号 Part Number 09990000021

退针器  
Removal tool



压接线径: 0.14-0.37mm<sup>2</sup>请选择TL02冷压钳  
Wire gauge: 0.14-0.37mm<sup>2</sup> please select TL02 Crimping tool  
适用类型 For 16A 冷压针 Crimp contacts 型号 Type TL01 订货号 Part Number 09990000059



HMD-012 冷压型模块 Crimp Module 250V 10A

插芯 Inserts



可与框架及其他所有模块产品组合使用  
Combination with hinged frame and other modules possible.

技术参数 Technical Characteristics

规范	Specifications	
规范	Specifications	DIN EN 60 664 DIN EN 61 984
插芯	Inserts	
接插件针数	Number Of Contacts	12
依据 EN 61 984 的电气数据	Electrical Data Acc. To EN 61 984	
-工作电流	-Rated Current	10A
-工作电压	-Rated Voltage	250V
-额定脉冲电压	-Rated Impulse Voltage	4kV
-污染程度	-Pollution Degree	3
依据UL/CSA的额定电压	Rated Voltage Acc. to UL/CSA	600V
绝缘电阻	Insulation Resistance	$\geq 10^{10} \Omega$
材料	Material	聚碳酸酯 Polycarbonate
工作温度范围	Limiting Temperatures	-40°C...+125°C
依据UL 94的阻燃等级	Flammability Acc. to UL94	V0
可拔插次数	Mechanical Working Life-mating Cycles	$\geq 500$
插针	Contacts	
材料	Material	铜合金 Copper Alloy
表面处理	Surface	镀银 Hard-silver Plated 镀金 Hard-gold Plated
接触电阻	Contact Resistance	$\leq 3m\Omega$
冷压连接	Cage Clamp Terminal	
- mm <sup>2</sup>	- mm <sup>2</sup>	0.14-2.5mm <sup>2</sup>
-AWG	-AWG	26-14

电流负载能力 Current Carrying Capacity

电流负载能力所受的限制主要来自包含接插针的接插体可承受的最大温度  
测试和控制过程依据 DIN EN 60512-5  
The current carrying is limited by maximum temperature of materials for Inserts and contacts including terminals.  
Measuring and testing techniques according to DIN EN 60512-5

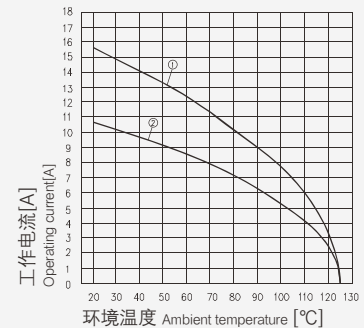

- ① 24 B外壳带6个模块，导线截面:2.5mm<sup>2</sup>
- ② 24 B外壳带6个模块，导线截面:1.5mm<sup>2</sup>
- ① 24 B hoods/housings with 6 modules, wire gauge:2.5mm<sup>2</sup>
- ② 24 B hoods/housings with 6 modules, wire gauge:1.5mm<sup>2</sup>

冷压连接 Crimp Terminal



插芯 Inserts	型号 Type	订货号 Part Number
公 Male	HMD-012-MC	09140123001
母 Female	HMD-012-FC	09140123101

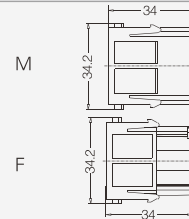

附件 Accessories

10A 冷压针 Crimp contacts

接触电阻 Contact resistance $\leq 3m\Omega$	公 Male	订货号 Part Number	母 Female	订货号 Part Number
镀银 Silver plated	CDSM-0.37	09150006104	CDSF-0.37	09150006204
	CDSM-0.5	09150006103	CDSF-0.5	09150006203
	CDSM-0.75	09150006105	CDSF-0.75	09150006205
	CDSM-1.0	09150006102	CDSF-1.0	09150006202
	CDSM-1.5	09150006101	CDSF-1.5	09150006201
	CDSM-2.5	09150006106	CDSF-2.5	09150006206
镀金 Gold plated	CDGM-0.37	09150006124	CDGF-0.37	09150006224
	CDGM-0.5	09150006123	CDGF-0.5	09150006223
	CDGM-0.75	09150006125	CDGF-0.75	09150006225
	CDGM-1.0	09150006122	CDGF-1.0	09150006222
	CDGM-1.5	09150006121	CDGF-1.5	09150006221
	CDGM-2.5	09150006126	CDGF-2.5	09150006226

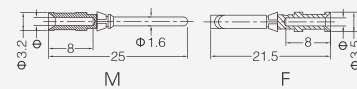

线规 Wire gauge	$\Phi$	剥线长度 Stripping length
0.14-0.37 mm <sup>2</sup>	AWG 26-22	0.9 8 mm
0.5 mm <sup>2</sup>	AWG 20	1.1 8 mm
0.75 mm <sup>2</sup>	AWG 18	1.3 8 mm
1 mm <sup>2</sup>	AWG 18	1.45 8 mm
1.5 mm <sup>2</sup>	AWG 16	1.75 8 mm
2.5 mm <sup>2</sup>	AWG 14	2.25 6 mm

工具 Tools

冷压钳 Crimping tool	压接线经 Wire gauge 0.14-4mm <sup>2</sup>	型号 Type TL02G	订货号 Part Number 09990000021
退针器 Removal tool	适用类型 For 10A 冷压针 Crimp contacts	型号 Type TL00	订货号 Part Number 09990000059







**HMDD-017 冷压型模块 Crimp Module 160V 10A**

**插芯 Inserts**



可与框架及其他所有模块产品组合使用  
Combination with hinged frame and other modules possible.

**技术参数 Technical Characteristics**

规范	Specifications	
规范	Specifications	DIN EN 60 664
		DIN EN 61 984
插芯	Inserts	
接插件针数	Number Of Contacts	17
依据 EN 61 984 的电气数据	Electrical Data Acc. To EN 61 984	
-工作电流	-Rated Current	10A
-工作电压	-Rated Voltage	160V
-额定脉冲电压	-Rated Impulse Voltage	2.5kV
-污染程度	-Pollution Degree	3
依据UL/CSA的额定电压	Rated Voltage Acc. to UL/CSA	250V
绝缘电阻	Insulation Resistance	$\geq 10^{10} \Omega$
材料	Material	聚碳酸酯 Polycarbonate
工作温度范围	Limiting Temperatures	-40°C...+125°C
依据UL 94的阻燃等级	Flammability Acc. to UL94	V0
可拔插次数	Mechanical Working Life-mating Cycles	$\geq 500$
插针	Contacts	
材料	Material	铜合金 Copper Alloy
表面处理	Surface	镀银 Hard-silver Plated 镀金 Hard-gold Plated
接触电阻	Contact Resistance	$\leq 3m\Omega$
冷压连接	Cage Clamp Terminal	
- mm <sup>2</sup>	- mm <sup>2</sup>	0.14-2.5mm <sup>2</sup>
-AWG	-AWG	26-14

**电流负载能力 Current Carrying Capacity**

电流负载能力所受的限制主要来自包含接插针的接插体可承受的最大温度  
测试和控制过程依据 DIN EN 60512-5  
The current carrying is limited by maximum temperature of materials for inserts and contacts including terminals.  
Measuring and testing techniques according to DIN EN 60512-5

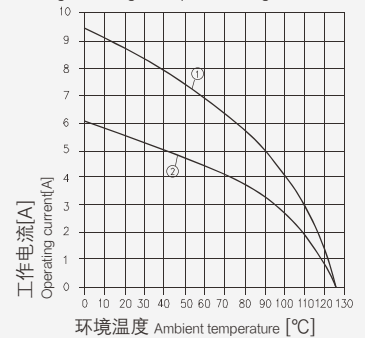

- ① 24 B外壳带6个模块, 导线截面:1.5mm<sup>2</sup>
- ② 24 B外壳带6个模块, 导线截面:1.0mm<sup>2</sup>
- ① 24 B hoods/housings with 6 modules, wire gauge:1.5mm<sup>2</sup>
- ② 24 B hoods/housings with 6 modules, wire gauge:1.0mm<sup>2</sup>

**冷压连接 Crimp Terminal**



插芯 Inserts	型号 Type	订货号 Part Number
公 Male	HMDD-017-MC	09140173001
母 Female	HMDD-017-FC	09140173101

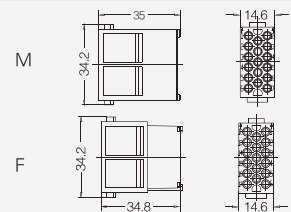

**附件 Accessories**

**10A 冷压针 Crimp contacts**

接触电阻 Contact resistance $\leq 3m\Omega$	公 Male	订货号 Part Number	母 Female	订货号 Part Number
镀银 Silver plated	CDSM-0.37	09150006104	CDSF-0.37	09150006204
	CDSM-0.5	09150006103	CDSF-0.5	09150006203
	CDSM-0.75	09150006105	CDSF-0.75	09150006205
	CDSM-1.0	09150006102	CDSF-1.0	09150006202
	CDSM-1.5	09150006101	CDSF-1.5	09150006201
	CDSM-2.5	09150006106	CDSF-2.5	09150006206
镀金 Gold plated	CDGM-0.37	09150006124	CDGF-0.37	09150006224
	CDGM-0.5	09150006123	CDGF-0.5	09150006223
	CDGM-0.75	09150006125	CDGF-0.75	09150006225
	CDGM-1.0	09150006122	CDGF-1.0	09150006222
	CDGM-1.5	09150006121	CDGF-1.5	09150006221
	CDGM-2.5	09150006126	CDGF-2.5	09150006226

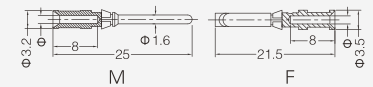

线规 Wire gauge	$\Phi$	剥线长度 Stripping length
0.14-0.37 mm <sup>2</sup>	AWG 26-22	0.9
0.5 mm <sup>2</sup>	AWG 20	1.1
0.75 mm <sup>2</sup>	AWG 18	1.3
1 mm <sup>2</sup>	AWG 18	1.45
1.5 mm <sup>2</sup>	AWG 16	1.75
2.5 mm <sup>2</sup>	AWG 14	2.25

**工具 Tools**

冷压钳 Crimping tool	压接线经 Wire gauge	型号 Type	订货号 Part Number
	0.14-4mm <sup>2</sup>	TL02G	09990000021
退针器 Removal tool	适用类型 For	型号 Type	订货号 Part Number
	10A 冷压针 Crimp contacts	TL00	09990000059



HMDS-009 D-Sub模块 Module 50V 5A

插芯 Inserts



可与框架及其他所有模块产品组合使用  
Combination with hinged frame and other modules possible.

技术参数 Technical Characteristics

规范	Specifications	
规范	Specifications	DIN EN 60 664 DIN EN 61 984
插芯	Inserts	
接插件针数	Number Of Contacts	9
依据 EN 61 984 的电气数据	Electrical Data Acc. To EN 61 984	
-工作电流	-Rated Current	5A
-工作电压	-Rated Voltage	50V
-额定脉冲电压	-Rated Impulse Voltage	0.8kV
-污染程度	-Pollution Degree	3
绝缘电阻	Insulation Resistance	$\geq 10^{10} \Omega$
材料	Material	聚碳酸酯 Polycarbonate
工作温度范围	Limiting Temperatures	-40°C...+125°C
依据UL 94 的阻燃等级	Flammability Acc. to UL94	V0
可拔插次数	Mechanical Working Life-mating Cycles	$\geq 500$
插针	Contacts	
材料	Material	铜合金 Copper Alloy
表面处理	Surface	镀银 Hard-silver Plated 镀金 Hard-gold Plated
接触电阻	Contact Resistance	$\leq 3m\Omega$
冷压连接	Cage Clamp Terminal	
- mm <sup>2</sup>	- mm <sup>2</sup>	0.09-0.82mm <sup>2</sup>
-AWG	-AWG	28-18

冷压连接 Crimp Terminal



插芯 Inserts	型号 Type	订货号 Part Number
公 Male	HMDS-009-MC	09140093001
母 Female	HMDS-009-FC	09140093101

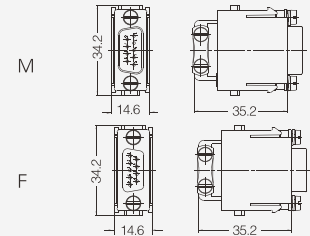

附件 Accessories

5A 冷压针 Crimp contacts

接触电阻 Contact resistance  $\leq 3m\Omega$   
镀银 Silver plated



公 Male	订货号 Part Number	母 Female	订货号 Part Number
CSSM-0.25	6103000010	CSSF-0.25	6103000012
CSSM-0.33	6103000018	CSSF-0.33	6103000020
CSSM-0.52	6103000028	CSSF-0.52	6103000030
CSSM-0.82	6103000040	CSSF-0.82	6103000042

镀金 Gold plated



CSGM-0.25	6103000078	CSGF-0.25	6103000080
CSGM-0.33	6103000094	CSGF-0.33	6103000096
CSGM-0.52	6103000073	CSGF-0.52	6103000074
CSGM-0.82	6103000082	CSGF-0.82	6103000084

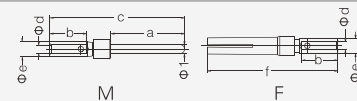

a	b	c	d	e	f
8.23	4.2	14.0	1.35	1.75	13.6
8.10	4.0	14.8	1.12	1.66	14.4
8.10	4.0	14.8	0.90	1.66	14.4
8.10	4.0	14.8	0.64	1.66	14.4

线规 Wire gauge	剥线长度 Stripping length	
0.09-0.21 mm <sup>2</sup>	AWG 28-24	5 mm
0.13-0.33 mm <sup>2</sup>	AWG 26-22	5 mm
0.33-0.52 mm <sup>2</sup>	AWG 22-20	5 mm
0.33-0.82 mm <sup>2</sup>	AWG 22-18	5 mm

工具 Tools

冷压钳  
Crimping tool



压接线经 Wire gauge	型号 Type	订货号 Part Number
0.09-0.82mm <sup>2</sup>	TL03	0999000001

退针器  
Removal tool



适用类型 For	型号 Type	订货号 Part Number
5A 冷压针 Crimp contacts	TL08	09990000368



**Global District Limited**

**HMDS-025 高密度型模块 50V 4A**

**插芯 Inserts**



可与框架及其他所有模块产品组合使用  
Combination with hinged frame and other modules possible.

**技术参数 Technical Characteristics**

规范	Specifications	
规范	Specifications	DIN EN 60 664 DIN EN 61 984
插芯	Inserts	
接插件针数	Number Of Contacts	25
依据 EN 61 984 的电气数据	Electrical Data Acc. To EN 61 984	
-工作电流	-Rated Current	4A
-工作电压	-Rated Voltage	50V
-额定脉冲电压	-Rated Impulse Voltage	0.8kV
-污染程度	-Pollution Degree	3
绝缘电阻	Insulation Resistance	$\geq 10^{10} \Omega$
材料	Material	聚碳酸酯 Polycarbonate
工作温度范围	Limiting Temperatures	-40°C...+125°C
依据UL 94的阻燃等级	Flammability Acc. to UL94	V0
可拔插次数	Mechanical Working Life-mating Cycles	$\geq 500$
插针	Contacts	
材料	Material	铜合金 Copper Alloy
表面处理	Surface	镀银 Hard-silver Plated 镀金 Hard-gold Plated
接触电阻	Contact Resistance	
冷压连接	Cage Clamp Terminal	$\leq 3m\Omega$
- mm <sup>2</sup>	- mm <sup>2</sup>	0.09-0.52mm <sup>2</sup>
-AWG	-AWG	28-20

**电流负载能力 Current Carrying Capacity**

电流负载能力所受的限制主要来自包含插针的接插体可承受的最大温度  
测试和控制过程依据 DIN EN 60512-5  
The current carrying is limited by maximum temperature of materials for Inserts and contacts including terminals.  
Measuring and testing techniques according to DIN EN 60512-5

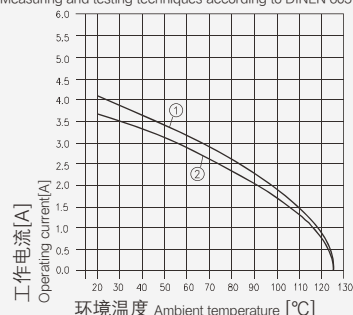

**冷压连接 Crimp Terminal**



插芯 Inserts	型号 Type	订货号 Part Number
公 Male	HMDS-025-MC	09140253001
母 Female	HMDS-025-FC	09140253101

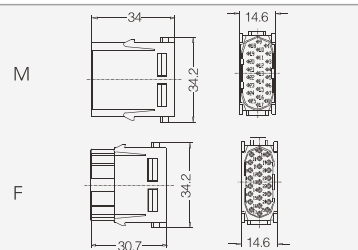

**附件 Accessories**

**5A**

接触电阻 Contact resistance  $\leq 3m\Omega$   
镀银 Silver plated



公 Male	订货号 Part Number	母 Female	订货号 Part Number
CSSM-0.25	61030000010	CSSF-0.25	61030000012
CSSM-0.33	61030000018	CSSF-0.33	61030000020
CSSM-0.52	61030000028	CSSF-0.52	61030000030
CSSM-0.82	61030000040	CSSF-0.82	61030000042

镀金 Gold plated



CSGM-0.25	61030000078	CSGF-0.25	61030000080
CSGM-0.33	61030000094	CSGF-0.33	61030000096
CSGM-0.52	61030000073	CSGF-0.52	61030000074
CSGM-0.82	61030000082	CSGF-0.82	61030000084

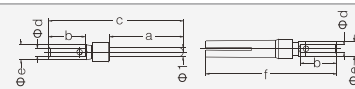

a	b	c	d	e	f
8.23	4.2	14.0	1.35	1.75	13.6
8.10	4.0	14.8	1.12	1.66	14.4
8.10	4.0	14.8	0.90	1.66	14.4
8.10	4.0	14.8	0.64	1.66	14.4

线规 Wire gauge	剥线长度 Stripping length
0.09-0.21 mm <sup>2</sup>	AWG 28-24 5 mm
0.13-0.33 mm <sup>2</sup>	AWG 26-22 5 mm
0.33-0.52 mm <sup>2</sup>	AWG 22-20 5 mm
0.33-0.82 mm <sup>2</sup>	AWG 22-18 5 mm

**工具 Tools**

冷压钳 Crimping tool



压接线经 Wire gauge	型号 Type	订货号 Part Number
0.09-0.82mm <sup>2</sup>	TL03	0999000001

退针器 Removal tool



适用类型 For	型号 Type	订货号 Part Number
5A 冷压针 Crimp contacts	TL08	09990000368



H2MDD-042冷压型模块 Crimp module 150V 10A

插芯 Inserts



可与框架及其他所有模块产品组合使用  
Combination with hinged frame and other modules possible.

技术参数 Technical Characteristics

规范	Specifications	
规范	Specifications	DIN EN 60 664
		DIN EN 61 984
插芯	Inserts	
接插件针数	Number of contacts	42
依据 EN 61 984 的电气数据	Electrical data acc. to EN 61 984	
-额定电流	-Rated current	10A
-额定电压	-Rated voltage	150V
-额定脉冲电压	-Rated impulse voltage	2.5kV
-污染程度	-Pollution degree	3
依据UL的额定电压	Rated voltage acc. to UL	250V
绝缘电阻	Insulation resistance	≥10 <sup>10</sup> Ω
材料	Material	聚碳酸酯
工作温度范围	Limiting temperatures	-40°C...+125°C
依据UL 94 的阻燃等级	Flammability acc. to UL 94	V0
可拔插次数	Mechanical working life	≥500
插针	- mating cycles	
材料	Material	铜合金
表面处理	Surface	镀银
		镀金
接触电阻	Contact resistance	
冷压连接	Crimp terminal	≤3mΩ
-mm <sup>2</sup>	-mm <sup>2</sup>	0.14-2.5mm <sup>2</sup>
-AWG	-AWG	26-14

冷压连接 冷压针需另外订购 Crimp terminal

插芯 Inserts	型号 Type	订货号 Part Number
公 Male	H2MDD-042-MC	129 042 010 0001
母 Female	H2MDD-042-FC	129 042 020 0001

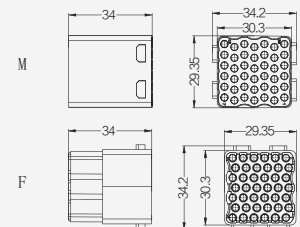

附件 Accessories

10A 冷压针 Crimp contacts

接触电阻 Contact resistance ≤3mΩ	公 Male	订货号 Part Number	母 Female	订货号 Part Number
镀银 Silver plated	CDSM-0.37	09150006104	CDSF-0.37	09150006204
	CDSM-0.5	09150006103	CDSF-0.5	09150006203
	CDSM-0.75	09150006105	CDSF-0.75	09150006205
	CDSM-1.0	09150006102	CDSF-1.0	09150006202
	CDSM-1.5	09150006101	CDSF-1.5	09150006201
	CDSM-2.5	09150006106	CDSF-2.5	09150006206
镀金 Gold plated	CDGM-0.37	09150006124	CDGF-0.37	09150006224
	CDGM-0.5	09150006123	CDGF-0.5	09150006223
	CDGM-0.75	09150006125	CDGF-0.75	09150006225
	CDGM-1.0	09150006122	CDGF-1.0	09150006222
	CDGM-1.5	09150006121	CDGF-1.5	09150006221
	CDGM-2.5	09150006126	CDGF-2.5	09150006226

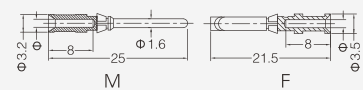

线规 Wire gauge	Φ	剥线长度 Stripping length
0.14-0.37 mm <sup>2</sup>	AWG 26-22	0.9
0.5 mm <sup>2</sup>	AWG 20	1.1
0.75 mm <sup>2</sup>	AWG 18	1.3
1 mm <sup>2</sup>	AWG 18	1.45
1.5 mm <sup>2</sup>	AWG 16	1.75
2.5 mm <sup>2</sup>	AWG 14	2.25

工具 Tools

冷压钳 Crimping tool	压接线经 Wire gauge	型号 Type	订货号 Part Number
	0.14-4mm <sup>2</sup>	TL02G	09990000021
退针器 Removal tool	适用类型 For	型号 Type	订货号 Part Number
	10A 冷压针 Crimp contacts	TL00	09990000059



Global District Limited

HM-RJ45 模块 Module 50V 5A

## 插芯 Inserts



可与框架及其他所有模块产品组合使用

Combination with hinged frame and other modules possible.

## 技术参数 Technical Characteristics

规范	Specifications	
规范	Specifications	DIN EN 60 664
		DIN EN 61 984
插芯	Inserts	
接插件针数	Number of contacts	8
依据 EN 61 984 的电气数据	Electrical data acc. to EN 61 984	
- 额定电流	- Rated current	1A
- 额定电压	- Rated voltage	50V
- 额定脉冲电压	- Rated impulse voltage	0.8kV
- 污染程度	- Pollution degree	3
依据 UL 的额定电压	Rated voltage acc. to UL	< 30 V
传输特性	Transmission features	Category 6 / Class E up to 500 MHz; acc. to ISO/IEC 11 801:2002 and EN 50 173-1
传输速率	Transmission rate	10/100/1000 Mbit/s
绝缘电阻	Insulation resistance	$\geq 10^{10} \Omega$
材料	Material	聚碳酸酯 polycarbonate
工作温度范围	Limiting temperatures	-40°C...+85°C
依据 UL 94 的阻燃等级	Flammability acc. to UL 94	V0
可拔插次数	Mechanical working life	
	- mating cycle	$\geq 500$

插芯 用于接缆线 Inserts for patch cable



插芯 Inserts	型号 Type	订货号 Part Number
公 Male	HM-RJ45-M	09140014623
母 Female	HM-RJ45-F	09140014721

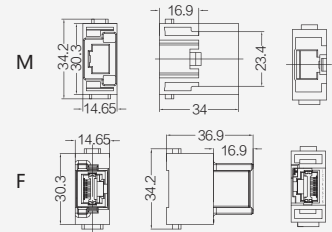

适配器 Adapter



描述 Inserts	型号 Type	订货号 Part Number
与公插芯搭配 go with male insert	HM-RJ45-APT	09140009966
仅用于标准电缆接线 for standard cable		

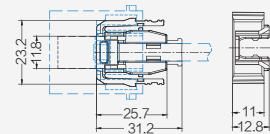



HMP-002 气动模块 Pneumatic Module

插芯 Inserts



可与框架及其他所有模块产品组合使用  
Combination with hinged frame and other modules possible.

技术参数 Technical Characteristics

规范	Specifications	
规范	Specifications	DIN EN 60 664 DIN EN 61 984
插芯	Inserts	
接插件针数	Number Of Contacts	2
材料	Material	聚碳酸酯 Polycarbonate
工作温度范围	Limiting Temperatures	-40°C...+80°C
依据UL 94的阻燃等级	Flammability Acc. To UI94	V0
可拔插次数	Mechknical Working Life-mating Cycles	≥500
插针	Contacts	
材料	Material	聚甲醛 Delrin Acetal
颜色	Colour	黑色 black
软管连接	Tube Termination-	
-内径	Internal Diameter (id)	6.0mm/1/4"
工作压力	Working Pressure	最大( Up To) 8 Bar/116 Psi
密封圈	Sealing	
-材料	-Material	丁晴橡胶 Buna-n
闭锁阀	Shut Off Valve	
-材料	-Material	聚丙烯 Polypropylen

气动模块 Pneumatic Module



描述 Description	型号 Type	订货号 Part Number
	HMP-002	09140024501

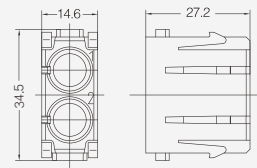

附件 Accessories

针 用于软管内径(ID) For Tubeinternal Diameter(ID)



描述 Description	类别 Category	ID	型号 Type	订货号 Part Number
无锁止 Without Shut Off	公 Male	6.0mm	PCM-6.0	09140006174
无锁止 Without Shut Off	母 Female	6.0mm	PCF-6.0	09140006274

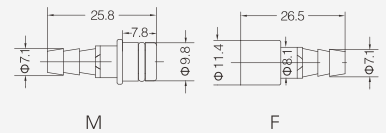

针 用于软管内径(ID) For Tubeinternal Diameter(ID)



描述 Description	类别 Category	ID	型号 Type	订货号 Part Number
带锁止 With Shut Off	母 Female	6.0mm	PCFS-6.0	09140006279

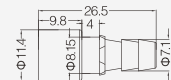



HMP-003 气动模块 Pneumatic Module

插芯 Inserts



可与框架及其他所有模块产品组合使用  
Combination with hinged frame and other modules possible.

技术参数 Technical Characteristics

规范	Specifications	
规范	Specifications	DIN EN 60 664 DIN EN 61 984
插芯	Inserts	
接插件针数	Number Of Contacts	3
材料	Material	聚碳酸酯 Polycarbonate
工作温度范围	Limiting Temperatures	-40°C...+80°C
依据UL 94的阻燃等级	Flammability Acc. To UI94	V0
可拔插次数	Mechknical Working Life-mating Cycles	≥500
插针	Contacts	
材料	Material	聚甲醛 Delrin Acetal
颜色	Colour	黑色black
软管连接	Tube Termination	
-内径	- Internal Diameter (id)	1.6mm/1/16 " 3mm 4mm/1/8 "
工作压力	Working Pressure	最大(Up To) 8 Bar/116 Psi
密封圈	Sealing	
-材料	-Material	丁晴橡胶 Buna-n
闭锁阀	Shut Off Valve	
-材料	-Material	聚丙烯 Polypropylen

气动模块 Pneumatic Module



描述 Description	型号 Type	订货号 Part Number
	HMP-003	09140034501

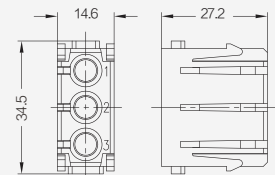

附件 Accessories

针 用于软管内径(ID) For Tubeinternal Diameter(ID)



描述 Description	类别 Category	ID	型号 Type	订货号 Part Number
无锁止 Without Shut Off	公 Male	1.6mm	PCM-1.6	09140006151
		3.0mm	PCM-3.0	09140006251
		4.0mm	PCM-4.0	09140006152
无锁止 Without Shut Off	母 Female	1.6mm	PCF-1.6	09140006252
		3.0mm	PCF-3.0	09140006153
		4.0mm	PCF-4.0	09140006253

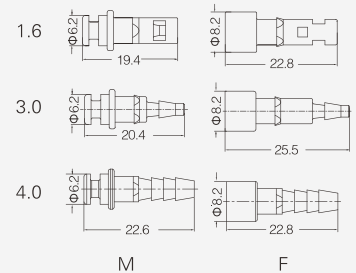

针 用于软管内径(ID) For Tubeinternal Diameter(ID)



描述 Description	类别 Category	ID	型号 Type	订货号 Part Number
带锁止 With Shut Off	母 Female	1.6mm	PCFS-1.6	09140006256
		3.0mm	PCFS-3.0	09140006257
		4.0mm	PCFS-4.0	09140006258

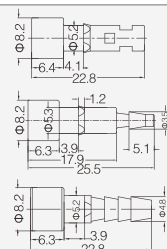



Q-Coax电磁屏蔽模块 Electromagnetic screening Module

技术参数 Technical Characteristics

规范	Specifications	
规范	Specifications	DIN EN 60 664 DIN EN 61 984
插芯	Inserts	
接插件针数	Number of contacts	1.2
绝缘电阻	Insulation resistance	$\geq 10^{10} \Omega$
材料	Material	聚碳酸酯 Polycarbonate
工作温度范围	Limiting temperatures	-40°C...+80°C
依据UL 94的阻燃等级	Flammability acc. to UL 94	V0
可拔插次数		$\geq 500$
Q-Coax针	Q-Coax contacts	
针数	Number of contacts	
-Q-Coax	- Q-Coax	4+屏蔽
-高密度Q-Coax	- High Density Q-Coax	8+屏蔽
依据 EN 61 984的电气数据	Electrical data acc. to EN 61 984	
-Q-Coax	- Q-Coax	10A 50V 0.8kV 3
-高密度Q-Coax	- High Density Q-Coax	5A 50V 0.8kV 3
额定电流	Rated current	10/5A
额定电压	Rated voltage	50V
额定脉冲电压	Rated impulse voltage	0.8kV
污染程度	Pollution degree	3
材料	Material	
-绝缘体	- Insulator	聚碳酸酯
-外导体	- Outer conductor	锌合金
接触电阻	Contact resistance	$\leq 4m \Omega$
工作温度范围	Limiting temperatures	-40°C...+80°C
依据UL94的阻燃等级	Flammability acc. to UL 94	V0
外导体表面	Outer surface finish	镍
电缆直径	Cable diameter	3-9.5mm
D-Sub冷压针 ( 5A )	D-Sub crimp contacts(5A)	
材料	Material	铜合金
表面处理	Surface	镀金
接触电阻	Contact resistance	$\leq 3m \Omega$
冷压连接	Crimp terminal	
-mm <sup>2</sup>	-mm <sup>2</sup>	0.09-0.52mm <sup>2</sup>
-AWG	-AWG	28-20
D型针 ( 10A )	D contacts(10A)	
材料	Material	银合金
表面处理	Surface	镀金
接触电阻	Contact resistance	$\leq 3m \Omega$
冷压连接	Crimp terminal	
-mm <sup>2</sup>	-mm <sup>2</sup>	0.14-2.5mm <sup>2</sup>
-AWG	-AWG	26-14

特征 Features

模块化结构

插入外壳不会造成屏蔽中断

屏蔽传导与外壳电势无关

仅当装入Q-Coax模块,Q-Coax针的插入才具极性

便于传输极灵敏信号(总线信号)

Shielding bus separate from housing potential

Perfect for transmission of sensitive signals

The four pole Q-Coax contact is suitable for

Ethernet Cat. 5e and PROFIBUS when diagonally

wiring of the data pairs.





## Q-Coax 插体使用说明 Assembly instructions

1. 剥除电缆护皮和屏蔽层
2. 将线压接到D型冷压针上
3. 将压好线的D型针插入到绝缘芯子内，直到卡紧为止。
4. 将已经安装好的芯子顺着卡位槽的方向装入到带屏蔽功能的金属外壳内。
5. 用电缆卡箍把屏蔽电缆固定起来(小卡箍3-6mm，大卡箍6-9.5mm)
6. 检查电缆线。
7. 合上金属外壳的盖子，并将其插入到相应腹腔的Q-Coax芯体内。

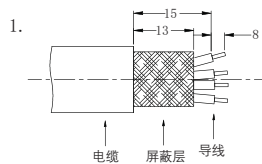

1. Strip cable acc. to drawing 1 and fold the shielding over the cable.
2. Crimp Dcontacts onto the wires.
3. Insert D contacts into corresponding cavities of insulator until they are snapped in.
4. Fit the insert including the cable into the opened shielded bushing.  
The coding pin of the shielded bushing has to meet the groove of the insulator.
5. Clamp the tilt over the shielding onto the cable by means of the special clamp (small opening for cablediameter of 3 – 6 mm, large opening for cable diameter of 6 – 9.5 mm).
6. Check the wiring.
7. Close the shielded bushing with the cover and insert it into the corresponding cavity of the Quintax Module as usual.

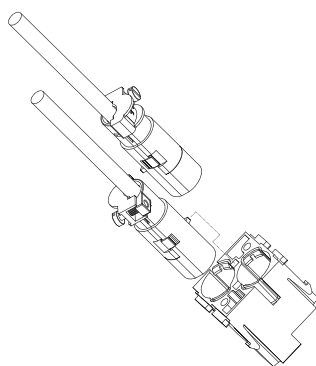

Step 1

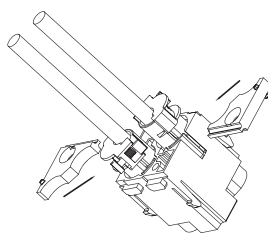

Step 2

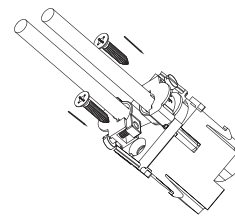

Step 3

## H2M-002-M/F 安装说明

第一步：将已装好Coax的芯子装入H2M-002-M/F的插体内。装入过程中，须将Coax插芯外壳上的“三角定位键”对准H2M-002-M/F插体上的“定位槽”，依此导向装入。听到“咔哒”一声，即装配到位，也就是卡勾卡住Coax的台阶面。

第二步：将适配器APT-H2MQ一对，依箭头方向，横向装入H2M-002-M/F与Coax芯子的固定台阶面。如图2

第三步：将适配器固定螺丝锁上，至此H2M-002-M/F模块的安装完成。

第四步：将安装好的H2M-002-M/F模块安装于模块框架上，

## Installation instruction of H2M-002-M/F

Step 1: slug of Coax that has been installed will be installed in the plug of H2M-002-M/F. "triangulation positioning key" on the housing of Coax mortise must be directed at the "positioning slot" on the plug of H2M-002-M/F in the installation process. In addition, assembly is completed if "click" is heard. Namely, step surface of Coax has been stuck by the card hook.

Step 2: a pair of APT-H2MQ adapter will be horizontally installed at the fixed step surface of H2M-002-M/F and Coax slug as per the arrow direction. Refer to the figure 2.

Step 3: the adapter will be fixed with the screw lock, which means that H2M-002-M/F module has been installed.



Global District Limited

Q-Coax 电磁屏蔽模块 Electromagnetic shielding module

装配说明详见P9-32 Assembly instructions see



可与框架及其他所有模块产品组合使用  
Combination with hinged frame and other modules possible.

冷压连接 Hoods, side entry



插芯 Insert	型号 Type	订货号 Part Number
公 Male	H2M-002-M	0914 002 3001
母 Female	H2M-002-F	0914 002 3101

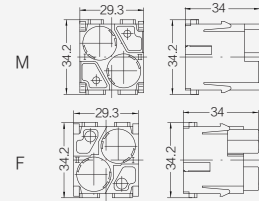

Q-Coax 金属适配器 metal adapter



描述 Description	型号 Type	订货号 Part Number
	APT-H2MQ	0914 000 9915

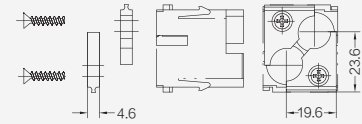

Q-Coax 4针 4+shielding

电缆直径3mm-9.5mm  
Cable diameter 3mm-9.5mm



插芯 Insert	型号 Type	订货号 Part Number
公 Male	EMC-004-MC	0915 004 3013
母 Female	EMC-004-FC	0915 004 3113

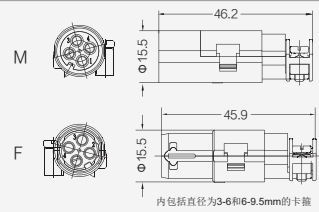

10A 冷压针需另外订购 Crimp contacts 10A Order crimp contacts separately

Q-Coax 8针 8+shielding

电缆直径3mm-9.5mm  
Cable diameter 3mm-9.5mm



插芯 Insert	型号 Type	订货号 Part Number
公 Male	EMC-008-MC	0915 008 3013
母 Female	EMC-008-FC	0915 008 3113

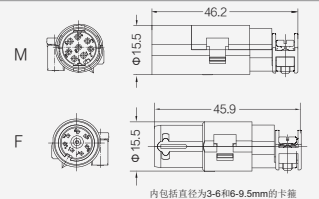

5A 冷压针需另外订购 Crimp contacts 5A Order crimp contacts separately

附件 Accessories

5A 冷压针 Crimp contacts

接触电阻 Contact resistance  $\leq 3m\Omega$   
镀金 Gold plated



公 Male	订货号 Part Number	母 Female	订货号 Part Number
CSGM-0.25	61030000078	CSGF-0.25	61030000080
CSGM-0.33	61030000094	CSGF-0.33	61030000096
CSGM-0.52	61030000073	CSGF-0.52	61030000074
CSGM-0.82	61030000082	CSGF-0.82	61030000084

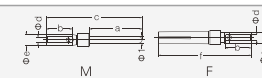

a	b	c	d	e	f
8.23	4.2	14.0	1.35	1.75	13.6
8.10	4.0	14.8	1.12	1.66	14.4
8.10	4.0	14.8	0.86	1.66	14.4
8.10	4.0	14.8	0.84	1.66	14.4

线规 Wire gauge	剥线长度 Stripping length
0.09-0.21 mm <sup>2</sup> AWG 28-24	5 mm
0.13-0.33 mm <sup>2</sup> AWG 26-22	5 mm
0.33-0.52 mm <sup>2</sup> AWG 22-20	5 mm
0.33-0.82 mm <sup>2</sup> AWG 22-18	5 mm

10A 冷压针 Crimp contacts

接触电阻 Contact resistance  $\leq 3m\Omega$   
镀金 Gold plated



公 Male	订货号 Part Number	母 Female	订货号 Part Number
CDGM-0.37	09150006124	CDGF-0.37	09150006224
CDGM-0.5	09150006123	CDGF-0.5	09150006223
CDGM-0.75	09150006125	CDGF-0.75	09150006225
CDGM-1.0	09150006122	CDGF-1.0	09150006222
CDGM-1.5	09150006121	CDGF-1.5	09150006221
CDGM-2.5	09150006126	CDGF-2.5	09150006226

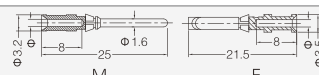

线规 Wire gauge	φ	剥线长度 Stripping length
0.14-0.37 mm <sup>2</sup> AWG 26-22	0.9	8 mm
0.5 mm <sup>2</sup> AWG 20	1.1	8 mm
0.75 mm <sup>2</sup> AWG 18	1.3	8 mm
1 mm <sup>2</sup> AWG 18	1.45	8 mm
1.5 mm <sup>2</sup> AWG 16	1.75	8 mm
2.5 mm <sup>2</sup> AWG 14	2.25	8 mm



**Global District Limited**

**Q-Coax 电磁屏蔽模块 Electromagnetic screening**

装配说明详见P10-63 Assembly instructions see P10-63.

外壳尺寸：匹配带密封圈 3A 外壳，详情请参考第10-64~10-70页。

Hoods/Housings : : size 3A with sealing, please find the details on page 10-64~10-70.

冷压连接 Crimp terminal



插芯 Inserts	型号 Type	订货号 Part Number
公 Male	H3A-001-M	0915 003 3001
母 Female	H3A-001-F	0915 003 3101

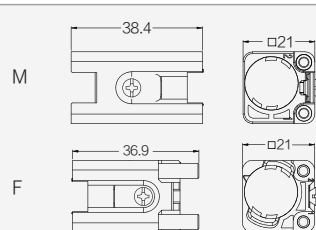

Q-Coax 4针 Q-Coax 4 + shielding

电缆直径3mm-9.5mm  
Cable diameter 3mm-9.5mm



插芯 Inserts	型号 Type	订货号 Part Number
公 Male	EMC-004-MC	0915 004 3013
母 Female	EMC-004-FC	0915 004 3113

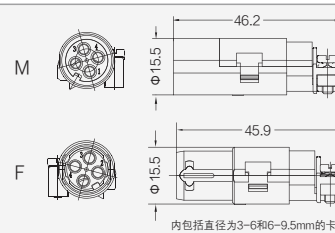

10A 冷压针需另外订购 Crimp contacts 10A Order crimp contacts separately

Q-Coax 8针 Q-Coax 8 + shielding

电缆直径3mm-9.5mm  
Cable diameter 3mm-9.5mm



插芯 Inserts	型号 Type	订货号 Part Number
公 Male	EMC-008-MC	0915 008 3013
母 Female	EMC-008-FC	0915 008 3113

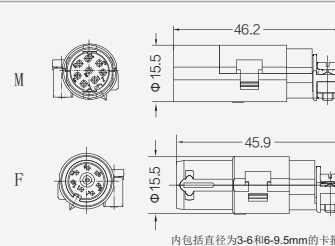

5A 冷压针需另外订购 Crimp contacts 5A Order crimp contacts separately

**附件 Accessories**

5A

镀金 Gold plated



公 Male	订货号 Part Number	母 Female	订货号 Part Number
CSGM-0.25	61030000078	CSGF-0.25	61030000080
CSGM-0.33	61030000094	CSGF-0.33	61030000096
CSGM-0.52	61030000073	CSGF-0.52	61030000074
CSGM-0.82	61030000082	CSGF-0.82	61030000084

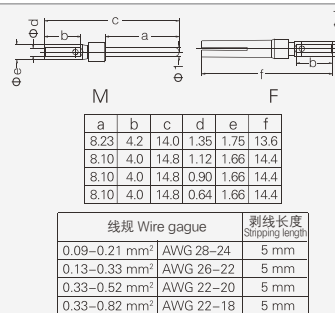

10A 冷压针 Crimp contacts

接触电阻 Contact resistance ≤3mΩ  
镀金 Gold plated



公 Male	订货号 Part Number	母 Female	订货号 Part Number
CDGM-0.37	09150006124	CDGF-0.37	09150006224
CDGM-0.5	09150006123	CDGF-0.5	09150006223
CDGM-0.75	09150006125	CDGF-0.75	09150006225
CDGM-1.0	09150006122	CDGF-1.0	09150006222
CDGM-1.5	09150006121	CDGF-1.5	09150006221
CDGM-2.5	09150006126	CDGF-2.5	09150006226

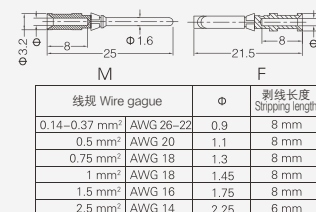



Coax 电磁屏蔽模块 Coax Electromagnetic screening module

技术参数 Technical Characteristics

规范	Specifications	
规范	Specifications	DIN EN 60 664
		DIN EN 61 984
插芯	Inserts	1,2
接插件针数	Number of contacts	≥10 10 Ω
绝缘电阻	Insulation resistance	聚碳酸酯
材料	Material	-40°C...+85°C
工作温度范围	Limiting temperatures	V0
阻燃等级	Flammability acc. to UL 94	≥500
可拔插次数	Mechanical working life(mating cycles)	
Coax针	Coax contacts	
针数	Number of contacts	1+屏蔽
依据 EN 61 984的电气数据	Electrical data acc. to EN 61 984	
-D型Coax针	- D Coax	10A 50V 0.8kV 3
-E型Coax针	- E Coax	16A 50V 0.8kV 3
额定电流	Rated current	10/16A
额定电压	Rated voltage	50V
额定脉冲电压	Rated impulse voltage	0.8kV
污染程度	Pollution degree	3
阻抗	Impedance	
-D型Coax针	- D Coax	75 Ω
-E型Coax针	- E Coax	50 Ω
材料	Material	
-绝缘体	- Insulator	聚碳酸酯
-外导体	- Outer conductor	锌合金
接触电阻	Contact resistance	≤4m Ω
工作温度范围	Limiting temperatures	-40°C...+85°C
依据UL94的阻燃等级	Flammability acc. to UL 94	V0
外导体表面	Outer surface finish	镍
电缆直径	Cable diameter	3-9.5mm
D型针(10A)	D Coax contacts (10A)	
材料	Material	铜合金
表面处理	Surface	镀金
接触电阻	Contact resistance	≤3m Ω
冷压连接	Crimp terminal	
-mm <sup>2</sup>	-mm <sup>2</sup>	0.14-2.5mm <sup>2</sup>
-AWG	-AWG	26-14
E型针 ( 16A )	E Coax contacts	
材料	Material	铜合金
表面处理	Surface	镀金
接触电阻	Contact resistance	≤1m Ω
冷压连接	Crimp terminal	
-mm <sup>2</sup>	-mm <sup>2</sup>	0.14-4mm <sup>2</sup>
-AWG	-AWG	26-12

特征 Features

模块化结构 Shielding bus separate from housing potential

插入外壳不会造成屏蔽中断 Perfect for transmission of sensitive signals

屏蔽传导与外壳电势无关 The four pole Q-Coax contact is suitable for

仅当装入Q-Coax模块,Q-Coax针的插入才具极性 Ethernet Cat. 5e and PROFIBUS when diagonally

便于传输极灵敏信号(总线信号) wiring of the data pairs.

传输性能 Transmission characteristics

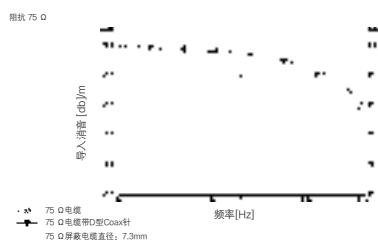

阻抗 50 Ω

E型针带 ETCS S21电缆(4 mm <sup>2</sup> )	27
MHz	
回波损耗 [db]	35,4
导入消音 [db]	0,017

E型针带 RG 213 电缆(2.5 mm <sup>2</sup> )	200	500	1,0	1,2	1,5	2,0	2,5
	MHz	MHz	GHz	GHz	GHz	GHz	GHz
回波损耗 [db]	23,8	21,1	>18,7	>17,7	>16,4	>14,1	>12,0
导入消音 [db]	0,07	0,11	0,17	0,2	<0,23	<0,53	< 2,0



# Global District Limited

## Coax 电磁屏蔽模块 Coax Electromagnetic screening module

装配说明详见P9-32 Assembly instructions see



可与框架及其他所有模块产品组合使用

Combination with hinged frame and other modules possible.

冷压连接 Hoods, side entry



插芯 Insert	型号 Type	订货号 Part Number
公 Male	H2M-002-M	0914 002 3001
母 Female	H2M-002-F	0914 002 3101

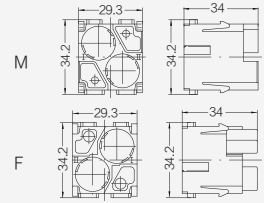

Q-Coax 金属适配器 metal adapter



描述 Description	型号 Type	订货号 Part Number
	APT-H2MQ	0914 000 9915

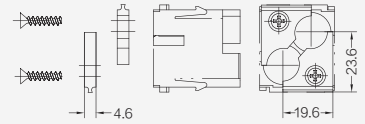

D型Coax D Coax 1 + shielding

阻抗 75Ω Impedance 75Ω  
电缆直径3mm-9.5mm  
Cable diameter 3mm-9.5mm



插芯 Insert	型号 Type	订货号 Part Number
公 Male	EMC-001-MC	0915 001 3013
母 Female	EMC-001-FC	0915 001 3113

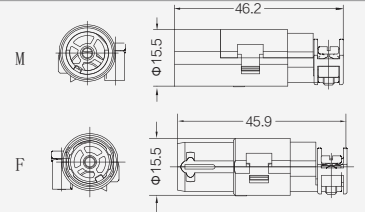

10A 冷压针需另外订购 Crimp contacts 10A Order crimp contacts separately

E型Coax E Coax 1 + shielding

阻抗 50Ω Crimp contacts 16A  
电缆直径3mm-9.5mm  
Cable diameter 3mm-9.5mm



插芯 Insert	型号 Type	订货号 Part Number
公 Male	EMC-001-MC/E	0915 001 3023
母 Female	EMC-001-FC/E	0915 001 3123

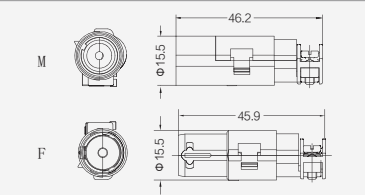

16A 冷压针需另外订购 Crimp contacts 16A Order crimp contacts separately

### 附件 Accessories

10A 冷压针 Crimp contacts

接触电阻 Contact resistance  $\leq 3m\Omega$   
镀金 Gold plated



公 Male	订货号 Part Number	母 Female	订货号 Part Number
CDGM-0.37	09150006124	CDGF-0.37	09150006224
CDGM-0.5	09150006123	CDGF-0.5	09150006223
CDGM-0.75	09150006125	CDGF-0.75	09150006225
CDGM-1.0	09150006122	CDGF-1.0	09150006222
CDGM-1.5	09150006121	CDGF-1.5	09150006221
CDGM-2.5	09150006126	CDGF-2.5	09150006226

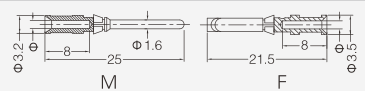

线规 Wire gauge	Φ	剥线长度 Stripping length
0.14-0.37 mm <sup>2</sup>	AWG 26-22	7.5mm
0.5 mm <sup>2</sup>	AWG 20	8 mm
0.75 mm <sup>2</sup>	AWG 18	8 mm
1 mm <sup>2</sup>	AWG 18	8 mm
1.5 mm <sup>2</sup>	AWG 16	8 mm
2.5 mm <sup>2</sup>	AWG 14	6 mm

16A 冷压针 Crimp contacts

接触电阻 Contact resistance  $\leq 1m\Omega$   
镀金 Gold plated



公 Male	订货号 Part Number	母 Female	订货号 Part Number
CEGM-0.37	09330006117	CEGF-0.37	09330006217
CEGM-0.5	09330006122	CEGF-0.5	09330006222
CEGM-0.75	09330006115	CEGF-0.75	09330006215
CEGM-1.0	09330006118	CEGF-1.0	09330006218
CEGM-1.5	09330006116	CEGF-1.5	09330006216
CEGM-2.5	09330006123	CEGF-2.5	09330006223
CEGM-4.0	09330006119	CEGF-4.0	09330006221

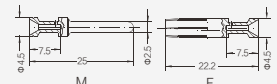

标示 Identification	线规 Wire gauge	剥线长度 Stripping length	
no groove	014-0.37mm <sup>2</sup>	AWG 26-22	7.5mm
no groove	0.5mm <sup>2</sup>	AWG 20	7.5mm
1 groove	0.75mm <sup>2</sup>	AWG 18	7.5mm
1 groove	1mm <sup>2</sup>	AWG 18	7.5mm
2 groove	1.5mm <sup>2</sup>	AWG 16	7.5mm
3 groove	2.5mm <sup>2</sup>	AWG 14	7.5mm
wide groove	3mm <sup>2</sup>	AWG 12	7.5mm
no groove	4mm <sup>2</sup>	AWG 12	7.5mm



Coax 电磁屏蔽模块 Coax Electromagnetic screening module

装配说明详见P10-63 Assembly instructions see P10-63. 外壳尺寸：匹配带密封圈 3A 外壳，详情请参考第10-64~10-70页。  
Hoods/Housings : : size 3A with sealing, please find the details on page 10-64~10-70.

冷压连接 Crimp terminal



插芯 Inserts	型号 Type	订货号 Part Number
公 Male	H3A-001-M	0915 003 3001
母 Female	H3A-001-F	0915 003 3101

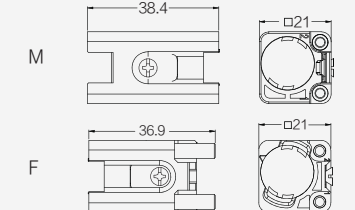

D型Coax 1针 D Coax 1 + shielding

阻抗 75Ω Impedance 75Ω  
电缆直径3mm-9.5mm  
Cable diameter 3mm-9.5mm

插芯 Inserts	型号 Type	订货号 Part Number
公 Male	EMC-001-MC	0915 001 3013
母 Female	EMC-001-FC	0915 001 3113

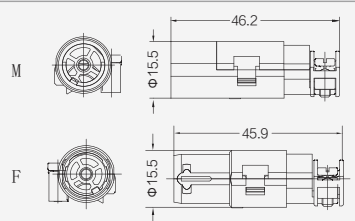

10A 冷压针需另外订购 Crimp contacts 10A Order crimp contacts separately

E型Coax 1针 E Coax 1 + shielding

阻抗 50Ω Impedance 50Ω  
电缆直径3mm-9.5mm  
Cable diameter 3mm-9.5mm

插芯 Inserts	型号 Type	订货号 Part Number
公 Male	EMC-001-MC/E	0915 001 3023
母 Female	EMC-001-FC/E	0915 001 3123

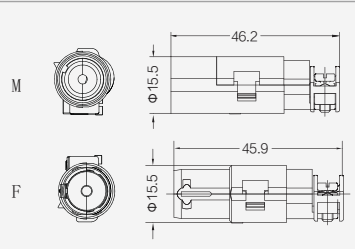

16A 冷压针需另外订购 Crimp contacts 16A Order crimp contacts separately

附件 Accessories

10A 冷压针 Crimp contacts

接触电阻 Contact resistance ≤ 3mΩ  
镀金 Gold plated



公 Male	订货号 Part Number	母 Female	订货号 Part Number
CDGM-0.37	09150006124	CDGF-0.37	09150006224
CDGM-0.5	09150006123	CDGF-0.5	09150006223
CDGM-0.75	09150006125	CDGF-0.75	09150006225
CDGM-1.0	09150006122	CDGF-1.0	09150006222
CDGM-1.5	09150006121	CDGF-1.5	09150006221
CDGM-2.5	09150006126	CDGF-2.5	09150006226

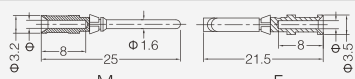

线规 Wire gauge		Φ	剥线长度 Stripping length
0.14-0.37 mm <sup>2</sup>	AWG 26-22	0.9	8 mm
0.5 mm <sup>2</sup>	AWG 20	1.1	8 mm
0.75 mm <sup>2</sup>	AWG 18	1.3	8 mm
1 mm <sup>2</sup>	AWG 18	1.45	8 mm
1.5 mm <sup>2</sup>	AWG 16	1.75	8 mm
2.5 mm <sup>2</sup>	AWG 14	2.25	6 mm

16A 冷压针 Crimp contacts

接触电阻 Contact resistance ≤ 1mΩ  
镀金 Gold plated



公 Male	订货号 Part Number	母 Female	订货号 Part Number
CEGM-0.37	09330006117	CEGF-0.37	09330006217
CEGM-0.5	09330006122	CEGF-0.5	09330006222
CEGM-0.75	09330006115	CEGF-0.75	09330006215
CEGM-1.0	09330006118	CEGF-1.0	09330006218
CEGM-1.5	09330006116	CEGF-1.5	09330006216
CEGM-2.5	09330006123	CEGF-2.5	09330006223
CEGM-4.0	09330006119	CEGF-4.0	09330006221

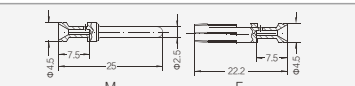

标示 Identification	线规 Wire gauge	剥线长度 Stripping length	
no groove	0.14-0.37mm <sup>2</sup>	AWG 26-22	7.5mm
no groove	0.5mm <sup>2</sup>	AWG 20	7.5mm
1 groove	0.75mm <sup>2</sup>	AWG 18	7.5mm
1 groove	1.1mm <sup>2</sup>	AWG 18	7.5mm
2 groove	1.5mm <sup>2</sup>	AWG 16	7.5mm
3 groove	2.5mm <sup>2</sup>	AWG 14	7.5mm
wide groove	3mm <sup>2</sup>	AWG 12	7.5mm
no groove	4mm <sup>2</sup>	AWG 12	7.5mm

**HQ-002/0 紧凑小体积型插芯 / Compact Series**
**技术参数 Technical Characteristics**

规范	Specifications	
规范	Specifications	DIN EN 60 664
		DIN EN 61 984
插芯	Inserts	
依据 EN 61 984的额定电压	Electrical Data Acc. To EN 61 984	
接插件针数	Number Of Contacts	2+PE
额定电流	Rated Current	40A
额定电压	Rated Voltage	400V
额定脉冲电压	Rated Impulse Voltage	6kV
污染程度	Pollution Degree	3
依据UL/CSA额定电压	Rated Voltage Acc.to UI CSA	400V
绝缘电阻	Insulation Resistance	$\geq 10^{10} \Omega$
材料	Material	聚碳酸酯 Polycarbonate
工作温度范围	Limiting Temperatures	-40°C...+125°C
依据UL94阻燃等级	Flammability Acc. To UL94	V0
可拔插次数	Mechanical Working Life-mating Cycles	$\geq 500$
插针	Contacts	
材料	Material	铜合金 Copper Alloy
表面处理	Surface	镀银 Hard-Silver Plated
接触电阻	Contact Resistance	$\leq 1m \Omega$
轴向螺栓连接	Axial Screw Termination	
mm <sup>2</sup>	mm <sup>2</sup>	2.5-10mm <sup>2</sup>
AWG	AWG	14-8
拧紧力矩	Tightening Torque	1.8Nm
剥线长度	Stripping Length	8mm <sup>±1</sup>
外壳	Hoods/housings	
塑料外壳	Plastic Hoods/housings	
-材料	-material	聚碳酸酯 Polycarbonate
-依据UL94的阻燃等级	-flammability Acc. To UL 94	V0
-连锁状态下依据DIN EN60 529的防护等级	-degree Of Protection Acc. To DIN EN60 529 For Coupled Connector	IP67
金属外壳	Hoods/housings, Metal	
-材料	-material	锌合金 Zinc Die-cast
-连锁状态下依据DIN EN60 529的防护等级	-degree Of Protection Acc. To DIN EN60 529 For Coupled Connector	IP44
		IP67(实现螺栓密封) is achieved with seal screw

**电流负载能力 Current Carrying Capacity**

电流负载能力所受的限制主要来自包含接插针的接插体可承受的最大温度

THQ current carrying is limited by maximum temperature of materials for Inserts and contacts including terminals.

测试和控制过程依据 Measuring and testing techniques according to DIN EN 60512-5

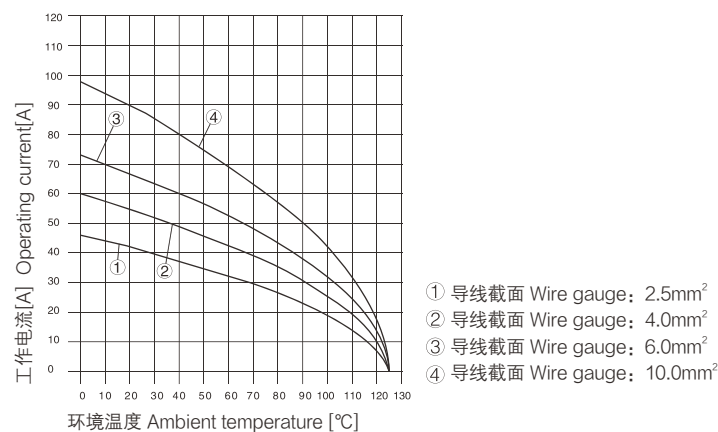



HQ-002/0 紧凑小体积型插芯 Compact Series 400V 40A 2+

插芯 Inserts

外壳尺寸：匹配3A外壳,详情请参考11-05~11-11页

Hoods/Housings : size 3A,detail please find the page P11-05~P11-11

轴向螺栓连接 Axial Screw Terminal



插芯 Inserts	型号 Type	订货号 Part Number
公 Male	HQ-002.1-M(2.5-6.0mm <sup>2</sup> )	09120022653
	HQ-002.2-M(4-10mm <sup>2</sup> )	09120022651
母 Female	HQ-002.1-F(2.5-6.0mm <sup>2</sup> )	09120022753
	HQ-002.2-F(4-10mm <sup>2</sup> )	09120022751

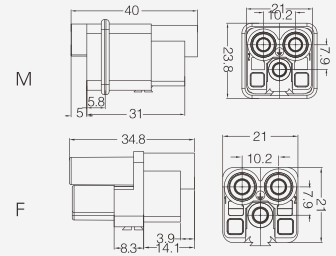

附件 Accessories

工具 Tools

内六角扳手  
Hexagonal driver



描述 Description	型号 Type	订货号 Part Number
用于轴向夹紧螺栓 带T型把手 For Axial Setscrew With Grip	SW-2x40	09990000363

编码元件 Coding Element



描述 Description	型号 Type	订货号 Part Number
编码、防呆 Coding、Pokayoke	CODE-Q2	09120009922





**HQV-002/0 紧凑小体积型插芯 / Compact Series**
**技术参数 Technical Characteristics**

规范	Specifications	
规范	Specifications	DIN EN 60 664
		DIN EN 61 984
插芯	Inserts	
依据 EN 61 984的额定电压	Electrical Data Acc. To EN 61 984	
接插件针数	Number Of Contacts	2+PE
额定电流	Rated Current	40A
额定电压	Rated Voltage	830V
额定脉冲电压	Rated Impulse Voltage	6kV
污染程度	Pollution Degree	3
依据UL/CSA额定电压	Rated Voltage Acc.to UI CSA	600V
绝缘电阻	Insulation Resistance	$\geq 10^{10} \Omega$
材料	Material	聚碳酸酯 Polycarbonate
工作温度范围	Limiting Temperatures	-40°C...+125°C
依据UL94阻燃等级	Flammability Acc. To UL94	V0
可拔插次数	Mechanical Working Life-mating Cycles	$\geq 500$
插针	Contacts	
材料	Material	铜合金 Copper Alloy
表面处理	Surface	镀银 Hard-Silver Plated
接触电阻	Contact Resistance	$\leq 1m\Omega$
轴向螺栓连接	Axial Screw Termination	
mm <sup>2</sup>	mm <sup>2</sup>	2.5-10mm <sup>2</sup>
AWG	AWG	14-8
拧紧力矩	Tightening Torque	1.8Nm
剥线长度	Stripping Length	8mm <sup>1</sup>
外壳	Hoods/housings	
塑料外壳	Plastic Hoods/housings	
-材料	-material	聚碳酸酯 Polycarbonate
-依据UL94的阻燃等级	-flammability Acc. To UL 94	V0
-连锁状态下依据DIN EN60 529的防护等级	-degree Of Protection Acc. To DIN EN60 529 For Coupled Connector	IP67
金属外壳	Hoods/housings, Metal	
-材料	-material	锌合金 Zinc Die-cast
-连锁状态下依据DIN EN60 529的防护等级	-degree Of Protection Acc. To DIN EN60 529 For Coupled Connector	IP44
		IP67(实现螺栓密封) is achieved with seal screw

**电流负载能力 Current Carrying Capacity**

电流负载能力所受的限制主要来自包含接插针的接插体可承受的最大温度

THQ current carrying is limited by maximum temperature of materials for Inserts and contacts including terminals.

测试和控制过程依据 Measuring and testing techniques according to DIN EN 60512-5

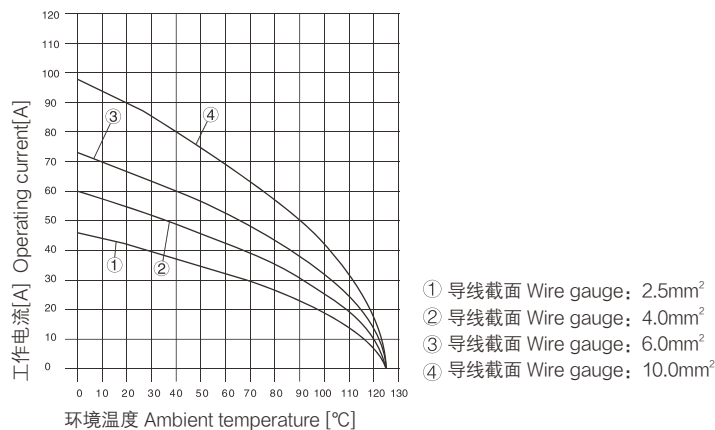



HQV-002/0 紧凑小体积型插芯 Compact Series 830V 40A 2+⊕

插芯 Inserts

外壳尺寸：匹配3A外壳,详情请参考11-05~11-11页

Hoods/Housings : size 3A,detail please find the page P11-05~P11-11

轴向螺栓连接 Axial Screw Terminal



插芯 Inserts	型号 Type	订货号 Part Number
公 Male	HQV-002.1-M(2.5-6.0mm <sup>2</sup> )	09120022654
	HQV-002.2-M(4-10mm <sup>2</sup> )	09120022652
母 Female	HQV-002.1-F(2.5-6.0mm <sup>2</sup> )	09120022754
	HQV-002.2-F(4-10mm <sup>2</sup> )	09120022752

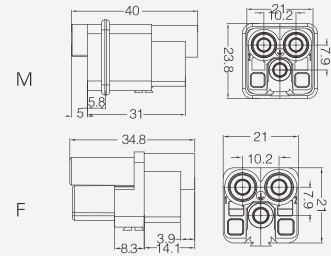

附件 Accessories

工具 Tools

内六角扳手  
Hexagonal driver



描述 Description	型号 Type	订货号 Part Number
用于轴向夹紧螺栓 带T型把手 For Axial Setscrew With Grip	SW-2x40	09990000363

编码元件 Coding Element



描述 Description	型号 Type	订货号 Part Number
编码、防呆 Coding、Pokayoke	CODE-Q2	09120009922

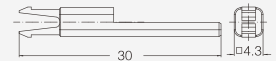

**HQ-005/0 紧凑小体积型插芯 / Compact Series**
**技术参数 Technical Characteristics**

规范	Specifications	
规范	Specifications	DIN EN 60 664 DIN EN 61 984
插芯	Inserts	
依据 EN 61 984的额定电压	Electrical Data Acc. To EN 61 984	
接插件针数	Number Of Contacts	5+PE
额定电流	Rated Current	16A
相对地额定电压	Rated voltage conductor-ground	230V
相间额定电压	Rated voltage conductor-conductor	400V
额定脉冲电压	Rated Impulse Voltage	4kV
污染程度	Pollution Degree	3
当污染等级2时的参数	Pollution Degree 2 Also	16A 320/500V 4kV 2
依据UL/CSA额定电压	Rated Voltage Acc.to UI CSA	600V
绝缘电阻	Insulation Resistance	$\geq 10^{10} \Omega$
材料	Material	聚碳酸酯 Polycarbonate
工作温度范围	Limiting Temperatures	-40°C...+125°C
依据UL94阻燃等级	Flammability Acc. To UL94	V0
可拔插次数	Mechanical Working Life-mating Cycles	$\geq 500$
插针	Contacts	
材料	Material	铜合金 Copper Alloy
表面处理	Surface	镀银 Hard-Silver Plated 镀金 Hard-gold Plated
接触电阻	Contact Resistance	$\leq 1m\Omega$
冷压连接	Crimp Terminal	
-mm <sup>2</sup>	-mm <sup>2</sup>	0.14-2.5mm <sup>2</sup>
-AWG	-AWG	26-14
PE螺钉连接	PE Screw Terminal	
-mm <sup>2</sup>	-mm <sup>2</sup>	2.5mm <sup>2</sup>
-AWG	-AWG	14
外壳	Hoods/housings	
塑料外壳	Plastic Hoods/housings	
-材料	-material	聚碳酸酯 Polycarbonate
-依据UL94的阻燃等级	-flammability Acc. To UL 94	V0
-连锁状态下依据DIN EN60 529的防护等级	-degree Of Protection Acc. To DIN EN60 529 For Coupled Connector	IP67
金属外壳	Hoods/housings, Metal	
-材料	-material	锌合金 Zinc Die-cast
-连锁状态下依据DIN EN60 529的防护等级	-degree Of Protection Acc. To DIN EN60 529 For Coupled Connector	IP44 IP67(实现螺栓密封) is achieved with seal screw

**电流负载能力 Current Carrying Capacity**

电流负载能力所受的限制主要来自包含接插针的接插体可承受的最大温度

THQ current carrying is limited by maximum temperature of materials for Inserts and contacts including terminals.

测试和控制过程依据 Measuring and testing techniques according to DIN EN 60512-5

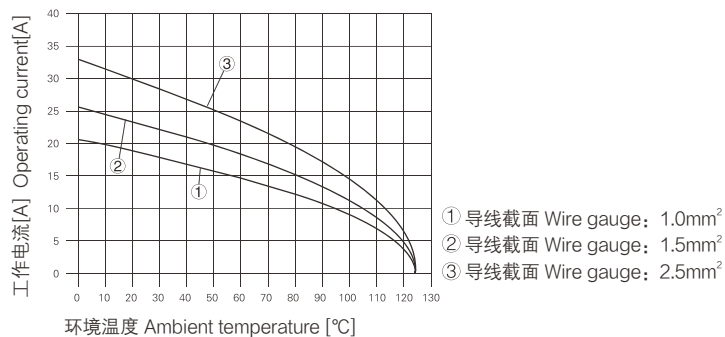



HQ-005/0 紧凑小体积型插芯 Compact Series 230/400V 16A 5+⊕

插芯 Inserts

外壳尺寸：匹配3A外壳,详情请参考11-05~11-11页

Hoods/Housings : size 3A,detail please find the page P11-05~P11-11

冷压连接 Crimp terminal



插芯 Inserts	型号 Type	订货号 Part Number
公 Male	HQ-005/0-MC	09120053001
母 Female	HQ-005/0-FC	09120053101

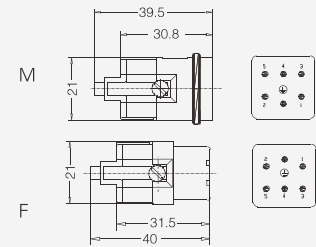

附件 Accessories

16A 冷压针 Crimp contacts

接触电阻 Contact resistance  $\leq 1m\Omega$   
镀银 Silver plated



公 Male	订货号 Part Number	母 Female	订货号 Part Number
CESM-0.37	09330006127	CESF-0.37	09330006227
CESM-0.5	09330006121	CESF-0.5	09330006220
CESM-0.75	09330006114	CESF-0.75	09330006214
CESM-1.0	09330006105	CESF-1.0	09330006205
CESM-1.5	09330006104	CESF-1.5	09330006204
CESM-2.5	09330006102	CESF-2.5	09330006202

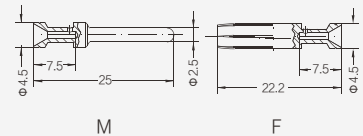

镀金 Gold plated



公 Male	订货号 Part Number	母 Female	订货号 Part Number
CEGM-0.37	09330006117	CEGF-0.37	09330006217
CEGM-0.5	09330006122	CEGF-0.5	09330006222
CEGM-0.75	09330006115	CEGF-0.75	09330006215
CEGM-1.0	09330006118	CEGF-1.0	09330006218
CEGM-1.5	09330006116	CEGF-1.5	09330006216
CEGM-2.5	09330006123	CEGF-2.5	09330006223

标示 Identification	线规 Wire gauge	剥线长度 Stripping length
no groove	0.14-0.37mm <sup>2</sup> AWG 26-22	7.5mm
no groove	0.5mm <sup>2</sup> AWG 20	7.5mm
1 groove	0.75mm <sup>2</sup> AWG 18	7.5mm
1 groove	1mm <sup>2</sup> AWG 18	7.5mm
2 groove	1.5mm <sup>2</sup> AWG 16	7.5mm
3 groove	2.5mm <sup>2</sup> AWG 14	7.5mm

保险延迟针 Relay contact

镀银 Silver plated



线规 Wire gauge(mm <sup>2</sup> )	型号 Type	订货号 Part Number
1	CESM-1.0R	09330006109
1.5	CESM-1.5R	09330006110
2.5	CESM-2.5R	09330006111

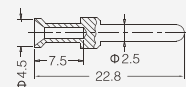

编码元件 Coding Element



描述 Description	型号 Type	订货号 Part Number
编码、防呆 Coding、Pokayoke	CODE-E	09330009954

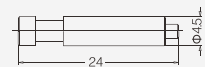

工具 Tools

冷压钳  
Crimping tool



压接线径 Wire gauge	型号 Type	订货号 Part Number
0.5-4mm <sup>2</sup>	TL02G	09990000021
压接线径: 0.14-0.37mm <sup>2</sup> 请选择TL02冷压钳 Wire gauge: 0.14-0.37mm <sup>2</sup> please select TL02 Crimping tool		

退针器  
Removal tool



适用类型 For	型号 Type	订货号 Part Number
16A 冷压针 Crimp contacts	TL01	09990000059

**HQ-007/0 紧凑小体积型插芯 / Compact Series**
**技术参数 Technical Characteristics**

规范	Specifications	
规范	Specifications	DIN EN 60 664
		DIN EN 61 984
插芯	Inserts	
依据 EN 61 984的额定电压	Electrical Data Acc. To EN 61 984	
接插件针数	Number Of Contacts	7+PE
额定电流	Rated Current	10A
额定电压	Rated Voltage	400V
额定脉冲电压	Rated Impulse Voltage	6kV
污染程度	Pollution Degree	3
当污染等级2时的参数	Pollution Degree 2 Also	10A 400/690V 6kV 2
依据UL/CSA额定电压	Rated Voltage Acc.to UI CSA	600V
绝缘电阻	Insulation Resistance	$\geq 10^{10}\Omega$
材料	Material	聚碳酸酯 Polycarbonate
工作温度范围	Limiting Temperatures	-40°C...+125°C
依据UL94阻燃等级	Flammability Acc. To UL94	V0
可接插次数	Mechanical Working Life-mating Cycles	$\geq 500$
插针	Contacts	
材料	Material	铜合金 Copper Alloy
表面处理	Surface	镀银 Hard-Silver Plated 镀金 Hard-Gold Plated
接触电阻	Contact Resistance	$\leq 3m\Omega$
冷压连接	Crimp Terminal	
-mm <sup>2</sup>	-mm <sup>2</sup>	0.14-2.5mm <sup>2</sup>
-AWG	-AWG	26-14
PE螺钉连接	PE Screw Terminal	
-mm <sup>2</sup>	-mm <sup>2</sup>	2.5mm <sup>2</sup>
-AWG	-AWG	14
外壳	Hoods/housings	
塑料外壳	Plastic Hoods/housings	
-材料	-material	聚碳酸酯 Polycarbonate
-依据UL94的阻燃等级	-flammability Acc. To UL 94	V0
-联锁状态下依据DIN EN60 529的防护等级	-degree Of Protection Acc. To DIN EN60 529 For Coupled Connector	IP67
金属外壳	Hoods/housings, Metal	
-材料	-material	锌合金 Zinc Die-cast
-联锁状态下依据DIN EN60 529的防护等级	-degree Of Protection Acc. To DIN EN60 529 For Coupled Connector	IP44 IP67(实现螺栓密封) is achieved with seal screw

**电流负载能力 Current Carrying Capacity**

电流负载能力所受的限制主要来自包含接插针的接插体可承受的最大温度

THQ current carrying is limited by maximum temperature of materials for Inserts and contacts including terminals.

测试和控制过程依据 Measuring and testing techniques according to DIN EN 60512-5

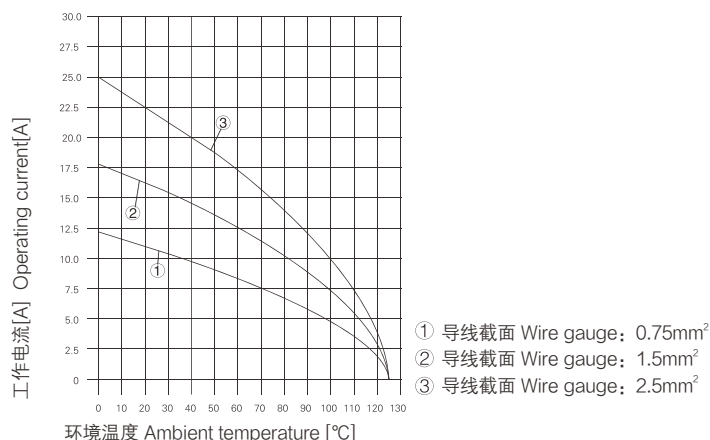

HQ-007/0 紧凑小体积型插芯 Compact Series 400V 10A 7+ ⊕

插芯 Inserts

外壳尺寸：匹配3A外壳,详情请参考11-05~11-11页

Hoods/Housings : size 3A,detail please find the page P11-05~P11-11

冷压连接 Crimp terminal



插芯 Inserts	型号 Type	订货号 Part Number
公 Male	HQ-007/0-MC	09120073001
母 Female	HQ-007/0-FC	09120073101

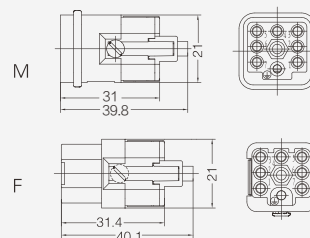

附件 Accessories

10A 冷压针 Crimp contacts

接触电阻 Contact resistance  $\leq 3m\Omega$   
镀银 Silver plated



公 Male	订货号 Part Number	母 Female	订货号 Part Number
CDSM-0.37	09150006104	CDSF-0.37	09150006204
CDSM-0.5	09150006103	CDSF-0.5	09150006203
CDSM-0.75	09150006105	CDSF-0.75	09150006205
CDSM-1.0	09150006102	CDSF-1.0	09150006202
CDSM-1.5	09150006101	CDSF-1.5	09150006201
CDSM-2.5	09150006106	CDSF-2.5	09150006206

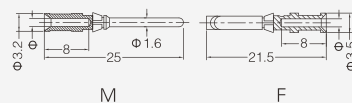

镀金 Gold plated



公 Male	订货号 Part Number	母 Female	订货号 Part Number
CDGM-0.37	09150006124	CDGF-0.37	09150006224
CDGM-0.5	09150006123	CDGF-0.5	09150006223
CDGM-0.75	09150006125	CDGF-0.75	09150006225
CDGM-1.0	09150006122	CDGF-1.0	09150006222
CDGM-1.5	09150006121	CDGF-1.5	09150006221
CDGM-2.5	09150006126	CDGF-2.5	09150006226

线规 Wire gauge	$\Phi$	剥线长度 Stripping length
0.14-0.37 mm <sup>2</sup>	AWG 26-22	0.9
0.5 mm <sup>2</sup>	AWG 20	1.1
0.75 mm <sup>2</sup>	AWG 18	1.3
1 mm <sup>2</sup>	AWG 18	1.45
1.5 mm <sup>2</sup>	AWG 16	1.75
2.5 mm <sup>2</sup>	AWG 14	2.25

编码元件 Coding Element



描述 Description	类别 Category	型号 Type	订货号 Part Number
编码、防呆	公 Male	CODE-Q7M	09120009901
Coding、Pokayoke	母 Female	CODE-Q7F	09120009902

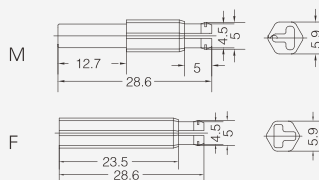

工具 Tools

冷压钳  
Crimping tool



压接线经 Wire gauge	型号 Type	订货号 Part Number
0.14-4mm <sup>2</sup>	TL02G	09990000021

退针器  
Removal tool



适用类型 For	型号 Type	订货号 Part Number
10A 冷压针 Crimp contacts	TL00	09990000059

## HQ-012/0 紧凑小体积型插芯 / Compact Series

## 技术参数 Technical Characteristics

规范	Specifications	
规范	Specifications	DIN EN 60 664
		DIN EN 61 984
插芯	Inserts	
依据 EN 61 984的额定电压	Electrical Data Acc. To EN 61 984	
接插件针数	Number Of Contacts	12+PE
额定电流	Rated Current	10A
额定电压	Rated Voltage	400V
额定脉冲电压	Rated Impulse Voltage	6kV
污染程度	Pollution Degree	3
当污染等级2时的参数	Pollution Degree 2 Also	10A 400/690V 6kV 2
依据UL/CSA额定电压	Rated Voltage Acc.to UI CSA	600V
绝缘电阻	Insulation Resistance	$\geq 10^{10}\Omega$
材料	Material	聚碳酸酯 Polycarbonate
工作温度范围	Limiting Temperatures	-40°C...+125°C
依据UL94阻燃等级	Flammability Acc. To UL94	V0
可拔插次数	Mechanical Working Life-mating Cycles	$\geq 500$
插针	Contacts	
材料	Material	铜合金 Copper Alloy
表面处理	Surface	镀银 Hard-Silver Plated 镀金 Hard-Gold Plated
接触电阻	Contact Resistance	$\leq 3m\Omega$
冷压连接	Crimp Terminal	
-mm <sup>2</sup>	-mm <sup>2</sup>	0.14-2.5mm <sup>2</sup>
-AWG	-AWG	26-14
PE螺钉连接	PE Screw Terminal	快速锁定终止 Quick Lock Termination
-mm <sup>2</sup>	-mm <sup>2</sup>	0.5-2.5mm <sup>2</sup>
-AWG	-AWG	20-14
外壳	Hoods/housings	
塑料外壳	Plastic Hoods/housings	
-材料	-material	聚碳酸酯 Polycarbonate
-依据UL94的阻燃等级	-flammability Acc. To UL 94	V0
-联锁状态下依据DIN EN60 529的防护等级	-degree Of Protection Acc. To DIN EN60 529 For Coupled Connector	IP67
金属外壳	Hoods/housings, Metal	
-材料	-material	锌合金 Zinc Die-cast
-联锁状态下依据DIN EN60 529的防护等级	-degree Of Protection Acc. To DIN EN60 529 For Coupled Connector	IP44
		IP67(实现螺栓密封) is achieved with seal screw

## 电流负载能力 Current Carrying Capacity

电流负载能力所受的限制主要来自包含接插针的接插体可承受的最大温度

THQ current carrying is limited by maximum temperature of materials for Inserts and contacts including terminals.

测试和控制过程依据 Measuring and testing techniques according to DIN EN 60512-5

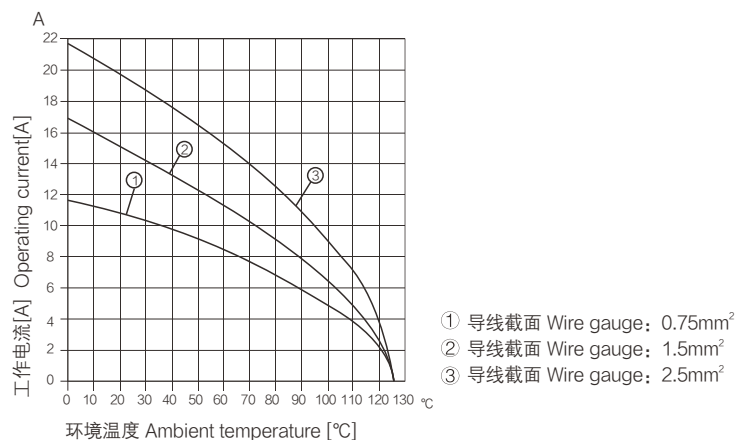

HQ-012/0 紧凑小体积型插芯 Compact Series 400V 10A 12+⊕

插芯 Inserts

外壳尺寸：匹配3A外壳,详情请参考11-05~11-11页

Hoods/Housings : size 3A,detail please find the page P11-05~P11-11

冷压连接 Crimp terminal

插芯 Inserts	型号 Type	订货号 Part Number
公 Male	HQ-012/0-MC	09120123001
母 Female	HQ-012/0-FC	09120123101

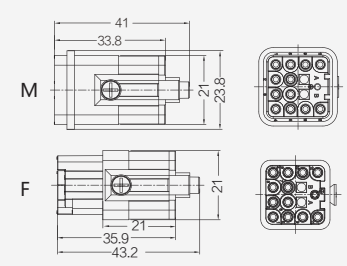
附件 Accessories

10A 冷压针 Crimp contacts

接触电阻 Contact resistance $\leq 3m\Omega$	公 Male	订货号 Part Number	母 Female	订货号 Part Number
镀银 Silver plated	CDSM-0.37	09150006104	CDSF-0.37	09150006204
	CDSM-0.5	09150006103	CDSF-0.5	09150006203
	CDSM-0.75	09150006105	CDSF-0.75	09150006205
	CDSM-1.0	09150006102	CDSF-1.0	09150006202
	CDSM-1.5	09150006101	CDSF-1.5	09150006201
	CDSM-2.5	09150006106	CDSF-2.5	09150006206

线规 Wire gauge	$\Phi$	剥线长度 Stripping length
0.14-0.37 mm <sup>2</sup>	AWG 26-22	0.9
0.5 mm <sup>2</sup>	AWG 20	1.1
0.75 mm <sup>2</sup>	AWG 18	1.3
1 mm <sup>2</sup>	AWG 18	1.45
1.5 mm <sup>2</sup>	AWG 16	1.75
2.5 mm <sup>2</sup>	AWG 14	2.25

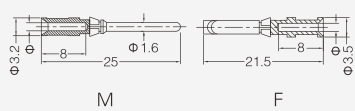
编码元件 Coding Element

描述 Description	型号 Type	订货号 Part Number
编码、防呆 Coding, Pokayoke	CODE-Q12	09120009924



工具 Tools

冷压钳 Crimping tool	压接线经 Wire gauge 0.14-4mm <sup>2</sup>	型号 Type TL02G	订货号 Part Number 09990000021
退针器 Removal tool	适用类型 For 10A 冷压针 Crimp contacts	型号 Type TL00	订货号 Part Number 09990000059





## HQ-008/0 紧凑小体积型插芯 / Compact Series

## 技术参数 Technical Characteristics

规范	Specifications	
规范	Specifications	DIN EN 60 664
		DIN EN 61 984
插芯	Inserts	
依据 EN 61 984的额定电压	Electrical Data Acc. To EN 61 984	
接插件针数	Number Of Contacts	8+PE
额定电流	Rated Current	16A
额定电压	Rated Voltage	500V
额定脉冲电压	Rated Impulse Voltage	6kV
污染程度	Pollution Degree	3
当污染等级2时的参数	Pollution Degree 2 Also	16A 400/690V 6kV 2
安装金属外壳时	Mounted Metal Hood	16A 230/400V 4kV 3
依据UL/CSA额定电压	Rated Voltage Acc.to UI CSA	600V
绝缘电阻	Insulation Resistance	$\geq 10^{10}\Omega$
材料	Material	聚碳酸酯 Polycarbonate
工作温度范围	Limiting Temperatures	-40°C...+125°C
依据UL94阻燃等级	Flammability Acc. To UL94	V0
可拔插次数	Mechanical Working Life-mating Cycles	$\geq 500$
插针	Contacts	
材料	Material	铜合金 Copper Alloy
表面处理	Surface	镀银 Hard-Silver Plated 镀金 Hard-Gold Plated
接触电阻	Contact Resistance	$\leq 1m\Omega$
冷压连接	Crimp Terminal	
-mm <sup>2</sup>	-mm <sup>2</sup>	0.14-2.5mm <sup>2</sup> (部分装备情况下可达到4mm <sup>2</sup> )
-AWG	-AWG	26-12
外壳	Hoods/housings	
塑料外壳	Plastic Hoods/housings	
-材料	-material	热塑性塑料 Hermoplastic
-联锁元件	-Locking element	聚酰胺 ( 尼龙 ) Polyamide
-外壳密封	-Hoods/Housings seal	丁晴橡胶 NBR
-工作温度范围	-Limiting temperatures	-40°C...+125°C
-依据UL94的阻燃等级	-flammability Acc. To UL 94	V0
-联锁状态下依据DIN EN60 529的防护等级	-degree Of Protection Acc. To DIN EN60 529 For Coupled Connector	IP65
金属外壳	Hoods/housings, Metal	
-材料	-material	金属 Metal
-联锁元件	-Locking element	不锈钢 Stainless Steel
-外壳密封	-Hoods/Housings seal	丁晴橡胶 NBR
-工作温度范围	-Limiting temperatures	-40°C...+125°C
-联锁状态下依据DIN EN60 529的防护等级	-degree Of Protection Acc. To DIN EN60 529 For Coupled Connector	IP65

## 电流负载能力 Current Carrying Capacity

电流负载能力所受的限制主要来自包含接插针的接插体可承受的最大温度

THQ current carrying is limited by maximum temperature of materials for Inserts and contacts including terminals.

测试和控制过程依据 Measuring and testing techniques according to DIN EN 60512-5

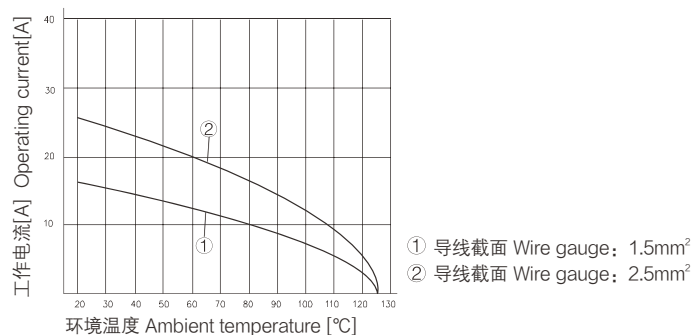

## HQ-008/0 紧凑小体积型插芯 Compact Series 500V 16A 8+⊕

## 插芯 Inserts

外壳尺寸：匹配HC外壳,详情请参考21-01~21-08页

Hoods/Housings : size HC,detail please find the page P21-01~P21-08

## 冷压连接 Crimp terminal



插芯 Inserts	型号 Type	订货号 Part Number
公 Male	HQ-008/0-MC	09120083001
母 Female	HQ-008/0-FC	09120083101

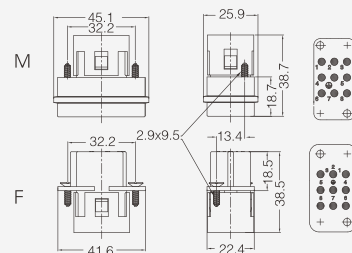

## 附件 Accessories

## 16A 冷压针 Crimp contacts

 接触电阻 Contact resistance  $\leq 1m\Omega$   
 镀银 Silver plated

公 Male	订货号 Part Number	母 Female	订货号 Part Number
CESM-0.37	09330006127	CESF-0.37	09330006227
CESM-0.5	09330006121	CESF-0.5	09330006220
CESM-0.75	09330006114	CESF-0.75	09330006214
CESM-1.0	09330006105	CESF-1.0	09330006205
CESM-1.5	09330006104	CESF-1.5	09330006204
CESM-2.5	09330006102	CESF-2.5	09330006202
CESM-3.0	09330006106	CESF-3.0	09330006206
CESM-4.0	09330006107	CESF-4.0	09330006207

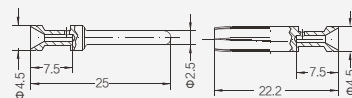

镀金 Gold plated



公 Male	订货号 Part Number	母 Female	订货号 Part Number
CEGM-0.37	09330006117	CEGF-0.37	09330006217
CEGM-0.5	09330006122	CEGF-0.5	09330006222
CEGM-0.75	09330006115	CEGF-0.75	09330006215
CEGM-1.0	09330006118	CEGF-1.0	09330006218
CEGM-1.5	09330006116	CEGF-1.5	09330006216
CEGM-2.5	09330006123	CEGF-2.5	09330006223
CEGM-4.0	09330006119	CEGF-4.0	09330006221

标示 Identification	线规 Wire gauge	剥线长度 Stripping length	
no groove	0.14-0.37mm <sup>2</sup>	AWG 26-22	7.5mm
no groove	0.5mm <sup>2</sup>	AWG 20	7.5mm
1 groove	0.75mm <sup>2</sup>	AWG 18	7.5mm
1 groove	1mm <sup>2</sup>	AWG 18	7.5mm
2 groove	1.5mm <sup>2</sup>	AWG 16	7.5mm
3 groove	2.5mm <sup>2</sup>	AWG 14	7.5mm
wide groove	3mm <sup>2</sup>	AWG 12	7.5mm
no groove	4mm <sup>2</sup>	AWG 12	7.5mm

## 保险延迟针 Relay contact

镀银 Silver plated



线规 Wire gauge(mm <sup>2</sup> )	型号 Type	订货号 Part Number
1	CESM-1.0R	09330006109
1.5	CESM-1.5R	09330006110
2.5	CESM-2.5R	09330006111

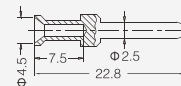

## 编码元件 Coding Element



描述 Description	型号 Type	订货号 Part Number
编码、防呆 Coding、Pokayoke	CODE-E	09330009954

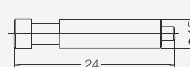

## 工具 Tools

 冷压钳  
Crimping tool

压接线径 Wire gauge	型号 Type	订货号 Part Number
0.5-4mm <sup>2</sup>	TL02G	09990000021

压接线径: 0.14-0.37mm<sup>2</sup>请选择TL02冷压钳  
 Wire gauge: 0.14-0.37mm<sup>2</sup> please select TL02 Crimping tool

 退针器  
Removal tool

适用类型 For	型号 Type	订货号 Part Number
16A 冷压针 Crimp contacts	TL01	09990000059



## HQ-017 紧凑小体积型插芯 / Compact Series

## 技术参数 Technical Characteristics

规范	Specifications	
规范	Specifications	DIN EN 60 664
		DIN EN 61 984
插芯	Inserts	
依据 EN 61 984的额定电压	Electrical Data Acc. To EN 61 984	
接插件针数	Number Of Contacts	17+PE
额定电流	Rated Current	10A
额定电压	Rated Voltage	250V
额定脉冲电压	Rated Impulse Voltage	4kV
污染程度	Pollution Degree	2
依据UL/CSA额定电压	Rated Voltage Acc.to UI CSA	250V
绝缘电阻	Insulation Resistance	$\geq 10^{10} \Omega$
材料	Material	聚碳酸酯 Polycarbonate
工作温度范围	Limiting Temperatures	-40°C...+125°C
依据UL94阻燃等级	Flammability Acc. To UL94	V0
可拔插次数	Mechanical Working Life-mating Cycles	$\geq 500$
插针	Contacts	
材料	Material	铜合金 Copper Alloy
表面处理	Surface	镀银 Hard-Silver Plated 镀金 Hard-Gold Plated
接触电阻	Contact Resistance	$\leq 3m \Omega$
冷压连接	Crimp Terminal	
-mm <sup>2</sup>	-mm <sup>2</sup>	0.14-2.5mm <sup>2</sup>
-AWG	-AWG	26-14
外壳	Hoods/housings	
塑料外壳	Plastic Hoods/housings	
-材料	-material	热塑性塑料 Hermoplastic
-联锁元件	-Locking element	聚酰胺 ( 尼龙 ) Polyamide
-外壳密封	-Hoods/Housings seal	丁晴橡胶 NBR
-工作温度范围	-Limiting temperatures	-40°C...+125°C
-依据UL94的阻燃等级	-flammability Acc. To UL 94	V0
-联锁状态下依据DIN EN60 529的防护等级	-degree Of Protection Acc. To DIN EN60 529 For Coupled Connector	IP65
金属外壳	Hoods/housings, Metal	
-材料	-material	金属 Metal
-联锁元件	-Locking element	不锈钢 Stainless Steel
-外壳密封	-Hoods/Housings seal	丁晴橡胶 NBR
-工作温度范围	-Limiting temperatures	-40°C...+125°C
-联锁状态下依据DIN EN60 529的防护等级	-degree Of Protection Acc. To DIN EN60 529 For Coupled Connector	IP65

## 电流负载能力 Current Carrying Capacity

电流负载能力所受的限制主要来自包含接插针的接插体可承受的最大温度

THQ current carrying is limited by maximum temperature of materials for Inserts and contacts including terminals.

测试和控制过程依据 Measuring and testing techniques according to DIN EN 60512-5

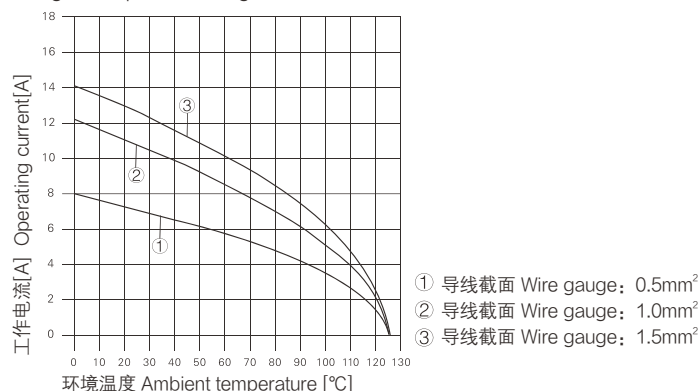

HQ-017 紧凑小体积型插芯 Compact Series 250V 10A 17+⊕

插芯 Inserts

外壳尺寸：匹配HC外壳,详情请参考21-01~21-08页  
Hoods/Housings : size HC,detail please find the page P21-01~P21-08

冷压连接 Crimp terminal



插芯 Inserts	型号 Type	订货号 Part Number
公 Male	HQ-017-MC	09120173001
母 Female	HQ-017-FC	09120173101

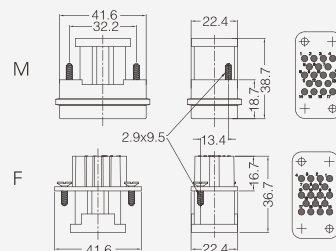

附件 Accessories

10A 冷压针 Crimp contacts

接触电阻 Contact resistance  $\leq 3m\Omega$   
镀银 Silver plated



公 Male	订货号 Part Number	母 Female	订货号 Part Number
CDSM-0.37	09150006104	CDSF-0.37	09150006204
CDSM-0.5	09150006103	CDSF-0.5	09150006203
CDSM-0.75	09150006105	CDSF-0.75	09150006205
CDSM-1.0	09150006102	CDSF-1.0	09150006202
CDSM-1.5	09150006101	CDSF-1.5	09150006201
CDSM-2.5	09150006106	CDSF-2.5	09150006206

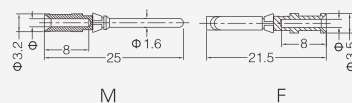

镀金 Gold plated



公 Male	订货号 Part Number	母 Female	订货号 Part Number
CDGM-0.37	09150006124	CDGF-0.37	09150006224
CDGM-0.5	09150006123	CDGF-0.5	09150006223
CDGM-0.75	09150006125	CDGF-0.75	09150006225
CDGM-1.0	09150006122	CDGF-1.0	09150006222
CDGM-1.5	09150006121	CDGF-1.5	09150006221
CDGM-2.5	09150006126	CDGF-2.5	09150006226

线规 Wire gauge	$\Phi$	剥线长度 Stripping length
0.14-0.37 mm <sup>2</sup>	AWG 26-22	0.9
0.5 mm <sup>2</sup>	AWG 20	1.1
0.75 mm <sup>2</sup>	AWG 18	1.3
1 mm <sup>2</sup>	AWG 18	1.45
1.5 mm <sup>2</sup>	AWG 16	1.75
2.5 mm <sup>2</sup>	AWG 14	2.25

工具 Tools

冷压钳  
Crimping tool



压接线经 Wire gauge	型号 Type	订货号 Part Number
0.14-4mm <sup>2</sup>	TL02G	09990000021

退针器  
Removal tool



适用类型 For	型号 Type	订货号 Part Number
10A 冷压针 Crimp contacts	TL00	09990000059

## HQ-004/2 紧凑小体积型插芯 / Compact Series

## 技术参数 Technical Characteristics

规范	Specifications	
规范	Specifications	DIN EN 60 664
		DIN EN 61 984
插芯	Inserts	
依据 EN 61 984的额定电压	Electrical Data Acc. To EN 61 984	
接插件针数	Number Of Contacts	4/2+PE
电力区	Power Side	
额定电流	Rated Current	40A
相对地额定电压	Rated Voltage Conductor-ground	400V
相间额定电压	Rated Voltage Conductor-conductor	690V
额定脉冲电压	Rated Impulse Voltage	6kV
污染程度	Pollution Degree	3
信号区	Signal Side	
额定电流	Rated Current	10A
额定电压	Rated Voltage	250V
额定脉冲电压	Rated Impulse Voltage	4kV
污染程度	Pollution Degree	3
依据UL/CSA额定电压	Rated Voltage Acc.to UI CSA	600/250V
绝缘电阻	Insulation Resistance	$\geq 10^{10} \Omega$
材料	Material	聚碳酸酯 Polycarbonate
工作温度范围	Limiting Temperatures	-40°C...+125°C
依据UL94阻燃等级	Flammability Acc. To UL94	V0
可拔插次数	Mechanical Working Life-mating Cycles	$\geq 500$
插针	Contacts	
材料	Material	铜合金 Copper Alloy
表面处理	Surface	镀银 Hard-Silver Plated 镀金 Hard-Gold Plated
接触电阻	Contact Resistance	$\leq 0.3m\Omega$
冷压连接	Crimp Terminal	
-mm <sup>2</sup>	-mm <sup>2</sup>	1.5-6mm <sup>2</sup> / 0.14-2.5mm <sup>2</sup>
-AWG	-AWG	16-10/26-14
最大绝缘直径	Max. insulation diameter	
-强电针	- Power contacts	5mm
外壳	Hoods/housings	
塑料外壳	Plastic Hoods/housings	
-材料	-material	热塑性塑料 Hermoplastic
-联锁元件	-Locking element	聚酰胺 ( 尼龙 ) Polyamide
-外壳密封	-Hoods/Housings seal	丁晴橡胶 NBR
-工作温度范围	-Limiting temperatures	-40°C...+125°C
-依据UL94的阻燃等级	-flammability Acc. To UL 94	V0
-联锁状态下依据DIN EN60 529的防护等级	-degree Of Protection Acc. To DIN EN60 529 For Coupled Connector	IP65

## 电流负载能力 Current Carrying Capacity

电流负载能力所受的限制主要来自包含接插针的接插体可承受的最大温度

THQ current carrying is limited by maximum temperature of materials for Inserts and contacts including terminals.

测试和控制过程依据 Measuring and testing techniques according to DIN EN 60512-5

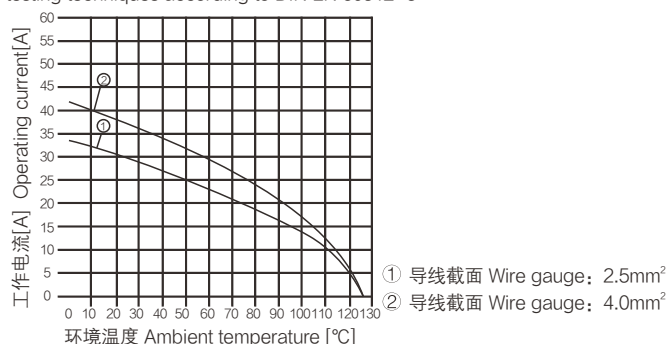

HQ-004/2 紧凑小体积型插芯 Compact Series 400/690V 40/10A 4/2+⊕

插芯 Inserts

外壳尺寸：匹配HC外壳,详情请参考21-01~21-08页  
Hoods/Housings : size HC,detail please find the page P21-01~P21-08

冷压连接 Crimp terminal



插芯 Inserts	型号 Type	订货号 Part Number
公 Male	HQ-004/2-MC	09120063041
母 Female	HQ-004/2-FC	09120063141

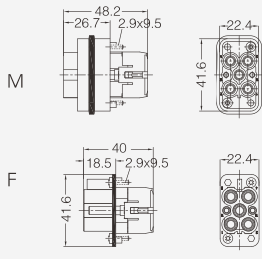

附件 Accessories

10A 冷压针 Crimp contacts

接触电阻 Contact resistance  $\leq 3m\Omega$   
镀银 Silver plated



公 Male	订货号 Part Number	母 Female	订货号 Part Number
CDSM-0.37	09150006104	CDSF-0.37	09150006204
CDSM-0.5	09150006103	CDSF-0.5	09150006203
CDSM-0.75	09150006105	CDSF-0.75	09150006205
CDSM-1.0	09150006102	CDSF-1.0	09150006202
CDSM-1.5	09150006101	CDSF-1.5	09150006201
CDSM-2.5	09150006106	CDSF-2.5	09150006206

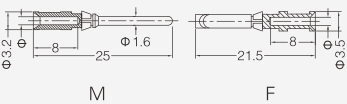

镀金 Gold plated



	订货号 Part Number	母 Female	订货号 Part Number
CDGM-0.37	09150006124	CDGF-0.37	09150006224
CDGM-0.5	09150006123	CDGF-0.5	09150006223
CDGM-0.75	09150006125	CDGF-0.75	09150006225
CDGM-1.0	09150006122	CDGF-1.0	09150006222
CDGM-1.5	09150006121	CDGF-1.5	09150006221
CDGM-2.5	09150006126	CDGF-2.5	09150006226

线规 Wire gauge	$\Phi$	剥线长度 Stripping length	
0.14-0.37 mm <sup>2</sup>	AWG 26-22	0.9	8 mm
0.5 mm <sup>2</sup>	AWG 20	1.1	8 mm
0.75 mm <sup>2</sup>	AWG 18	1.3	8 mm
1 mm <sup>2</sup>	AWG 18	1.45	8 mm
1.5 mm <sup>2</sup>	AWG 16	1.75	8 mm
2.5 mm <sup>2</sup>	AWG 14	2.25	6 mm

40A 冷压针 Crimp contacts

接触电阻  $\leq 0.3 m\Omega$   
Contact resistance  $\leq 0.3 m\Omega$   
镀银 silver plated



公 Male	订货号 Part Number	母 Female	订货号 Part Number
CCSM-1.5	09320006104	CCSF-1.5	09320006204
CCSM-2.5	09320006105	CCSF-2.5	09320006205
CCSM-4.0	09320006107	CCSF-4.0	09320006207
CCSM-6.0	09320006108	CCSF-6.0	09320006208
CCSM-10.0	09320006109	CCSF-10.0	09320006209

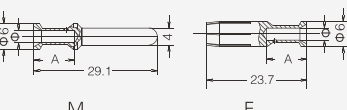

导线截面 Wire gauge	$\Phi$	剥线长度 Stripping length	
1.5 mm <sup>2</sup>	AWG 16	1.75	9 mm
2.5 mm <sup>2</sup>	AWG 14	2.25	9 mm
4 mm <sup>2</sup>	AWG 12	2.85	9.6 mm

工具 Tools

冷压钳  
Crimping tool



压接线经 Wire gauge	型号 Type	订货号 Part Number
0.14-4mm <sup>2</sup>	TL02G	09990000021
1.5-6mm <sup>2</sup>	TL02-0G	09990000110

退针器  
Removal tool



适用类型 For	型号 Type	订货号 Part Number
10A 冷压针 Crimp contacts	TL00	09990000059
40A 冷压针 Crimp contacts	TL06	09990000305



外壳部分 / Hoods & Housings Contents

规格Size	页码Page
3A外壳Hoods/Housings	P11-01~P11-11
10A外壳Hoods/Housings	P12-01~P12-02
16A外壳Hoods/Housings	P13-01~P13-02
32A外壳Hoods/Housings	P14-01~P14-02
6B外壳Hoods/Housings	P15-01~P15-10
10B外壳Hoods/Housings	P16-01~P16-13
16B外壳Hoods/Housings	P17-01~P17-21
24B外壳Hoods/Housings	P18-01~P18-22
32B外壳Hoods/Housings	P19-01~P19-06
48B外壳Hoods/Housings	P20-01~P20-02
HC外壳Hoods/Housings	P21-01~P21-08

**外壳部分 / Hoods & Housings Contents**

3A 塑料外壳 IP65 / Size 3A Plastic Hoods & Housings IP65		
材料	Material	聚碳酸酯 Polycarbonate
颜色	Colour	灰白 Light grey(RAL 7032)
联锁元件	Locking element	
-联锁方式	-Lever type	塑料弹性压合 Lever,plastic
-材料	-Material	聚酰胺 Polyamide
密封元件	Hoods & Housings seal	NBR
适用温度范围	Limiting temperatures	-40...+125°C
阻燃等级	Flammability acc. to UL 94	V0
防护等级(联锁状态,EN60529)	Degree of protection acc.to DIN EN 60 529 for coupled connector	IP65

塑料外壳 IP65 / Plastic Hoods & Housings IP65		
材料	Material	PA+20GF
颜色	Colour	深蓝色 Prussian blue
联锁元件	Locking element	
-联锁方式	-Lever type	塑料弹性压合 Lever,plastic
-材料	-Material	PA+20GF
密封元件	Hoods & Housings seal	NBR
适用温度范围	Limiting temperatures	-40...+125°C
阻燃等级	Flammability acc. to UL 94	V0
防护等级(联锁状态,EN60529)	Degree of protection acc.to DIN EN 60 529 for coupled connector	IP65

3A 金属外壳 IP65 / Size 3A Metal Hoods & Housings IP65		
材料	Material	铸锌 zinc die-cast
颜色	Colour	灰色 Grey
联锁元件	Locking element	
-联锁方式	-Lever type	金属弹性压合 Lever
-材料	-Material	金属(铁)镀锌 metal galvanized/nickel plating
密封元件	Hoods & Housings seal	NBR
适用温度范围	Limiting temperatures	-40...+125°C
阻燃等级	Flammability acc. to UL 94	V0
防护等级(联锁状态,EN60529)	Degree of protection acc.to DIN EN 60 529 for coupled connector	IP65

金属外壳 IP65 / Metal Hoods & Housings IP65		
材料	Material	铸铝合金 Aluminium die-cast,corrosion resistant
颜色	Colour	灰色 Grey
联锁元件	Locking element	
-联锁方式	-Lever type	金属弹性压合 Lever
-材料	-Material	金属(铁)镀锌 metal galvanized/nickel plating
密封元件	Hoods & Housings seal	NBR
适用温度范围	Limiting temperatures	-40...+125°C
阻燃等级	Flammability acc. to UL 94	V0
防护等级(联锁状态,EN60529)	Degree of protection acc.to DIN EN 60 529 for coupled connector	IP65

3A 高防护外壳 IP68 / Size 3A Pressure tight Hoods & Housings IP68		
表面处理	Surface	喷涂/镀铬 Epoxy power paint/Chromated
材料	Material	铸锌 zinc die-cast
颜色	Colour	黑色/灰色 Black or grey
联锁元件	Locking element	
-联锁方式	-Lever type	螺栓连接 Screw locking
-材料	-Material	不锈钢 Stainless steel
密封元件	Hoods & Housings seal	NBR
适用温度范围	Limiting temperatures	-40...+125°C
阻燃等级	Flammability acc. to UL 94	V0
防护等级(联锁状态,EN60529)	Degree of protection acc.to DIN EN 60 529 for coupled connector	IP68





外壳部分 / Hoods & Housings Contents

耐腐蚀(高环境)外壳 IP65 /		
表面处理	Surface	环氧粉末涂料 Epoxy powder
材料	Material	铸铝合金 Aluminium die-cast, corrosion resistant
颜色	Colour	RAL 9005(黑色Black)
联锁元件	Locking element	
-联锁方式	-Lever type	金属弹性压合 Lever
-材料	-Material	不锈钢 Stainless steel
密封元件	Hoods & Housings seal	NBR
适用温度范围	Limiting temperatures	-40...+125°C
阻燃等级	Flammability acc. to UL 94	V0
防护等级(联锁状态,EN60529)	Degree of protection acc.to DIN EN 60 529 for coupled connector	IP65
EMC电磁兼容外壳 / EMC Electromagnetic Compatibility Hoods & Housings IP65		
材料	Material	铸锌 zinc die-cast
颜色	Colour	
联锁元件	Locking element	
-联锁方式	-Lever type	金属(铁)弹性压合/螺栓连接 Lever/screw locking
-材料	-Material	金属(铁)镀锌 metal galvanized/nickel plating
密封元件	Hoods & Housings seal	NBR
适用温度范围	Limiting temperatures	-40...+125°C
阻燃等级	Flammability acc. to UL 94	V0
防护等级(联锁状态,EN60529)	Degree of protection acc.to DIN EN 60 529 for coupled connector	IP65
高防护外壳 IP68 / Pressure tight Hoods & Housings IP68		
材料	Material	铸铝合金 Aluminium die-cast, corrosion resistant
颜色	Colour	黑色或灰色 Black or grey
联锁元件	Locking element	
-联锁方式	-Lever type	螺栓连接 Screw locking
-材料	-Material	不锈钢 Stainless steel
密封元件	Hoods & Housings seal	NBR
适用温度范围	Limiting temperatures	-40...+125°C
阻燃等级	Flammability acc. to UL 94	V0
防护等级(联锁状态,EN60529)	Degree of protection acc.to DIN EN 60 529 for coupled connector	IP68
HC 金属外壳 IP65 / HC Metal Hoods & Housings IP65		
表面处理	Surface	喷涂/镀铬/镀镍 Epoxy power paint/Chromated/nickeling
材料	Material	铸锌 zinc die-cast
颜色	Colour	黑色/黑色/亚光镍 Black/brushed nickel
联锁元件	Locking element	
-联锁方式	-Lever type	金属弹性压合 Lever
-材料	-Material	不锈钢 Stainless steel
密封元件	Hoods & Housings seal	NBR
适用温度范围	Limiting temperatures	-40...+125°C
阻燃等级	Flammability acc. to UL 94	V0
防护等级(联锁状态,EN60529)	Degree of protection acc.to DIN EN 60 529 for coupled connector	IP65
HC 塑料外壳 IP65 / HCPlastic Hoods & Housings IP65		
材料	Material	聚碳酸酯 Polycarbonate
颜色	Colour	灰白 Light grey(RAL 7032)
联锁元件	Locking element	
-联锁方式	-Lever type	塑料弹性压合 Lever,plastic
-材料	-Material	聚酰胺 Polyamide
密封元件	Hoods & Housings seal	NBR
适用温度范围	Limiting temperatures	-40...+125°C
阻燃等级	Flammability acc. to UL 94	V0
防护等级(联锁状态,EN60529)	Degree of protection acc.to DIN EN 60 529 for coupled connector	IP65









**Global District Limited**





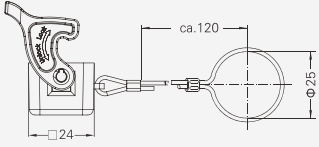

3A 塑料外壳 Plastic Hoods & Housings

防护等级 Degree of protection : IP65

防护盖 Protection covers

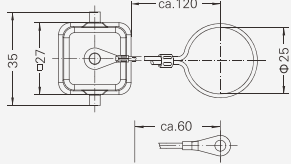
		<b>型号 Type</b> H3A-CV-1L/1M (配公芯 for male insert)	<b>订货号 Part Number</b> 09200035442	
		<b>型号 Type</b> H3A-CV-1L/1F (配母芯 for female insert)	<b>订货号 Part Number</b> 09200035441	

防护盖 Protection covers

		<b>型号 Type</b> H3A-CV-2B/1M (配公芯 for male insert)	<b>订货号 Part Number</b> 09200035448	
		<b>型号 Type</b> H3A-CV-2B/2M (配公芯 for male insert)	<b>订货号 Part Number</b> 09200035446	
		<b>型号 Type</b> H3A-CV-2B/1F (配母芯 for female insert)	<b>订货号 Part Number</b> 09200035447	
		<b>型号 Type</b> H3A-CV-2B/2F (配母芯 for female insert)	<b>订货号 Part Number</b> 09200035445	



3A 金属外壳 Metal Hoods & Housings

防护等级 Degree of protection : IP65

上壳 侧出线 Hoods, side entry



螺纹 Thread	型号 Type	订货号 Part Number
M20	H3A-SE-2B-M20	19200031640
PG11	H3A-SE-2B-PG11	09200031640

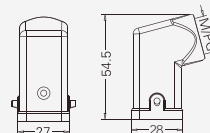

上壳 顶出线 Hoods, top entry



螺纹 Thread	型号 Type	订货号 Part Number
M20	H3A-TE-2B-M20	19200031440
PG11	H3A-TE-2B-PG11	09200031440
PG13.5	H3A-TE-2B-PG13.5	09200031441

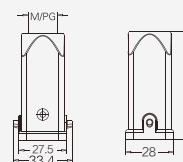

新增M25新品, 详见P11-09 (New M25 products, see P11-09)

不封底下壳 Housings, bulkhead mounting



螺纹 Thread	型号 Type	订货号 Part Number
---	H3A-BK-1L	09200030301

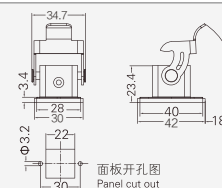

不封底下壳 Housings, bulkhead mounting



螺纹 Thread	型号 Type	订货号 Part Number
---	H3A-BK-1L-MCV/M (配公芯for male insert)	09200030305
---	H3A-BK-1L-MCV/F (配母芯for female insert)	09200030306

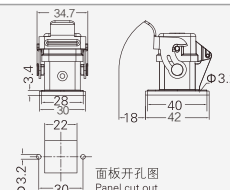

不封底下壳 Housings, bulkhead mounting



螺纹 Thread	型号 Type	订货号 Part Number
---	H3A-BK-1L-SE	09200030801

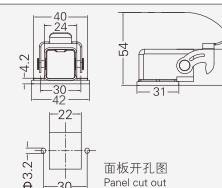

封底下壳 Housings, surface mounting



螺纹 Thread	型号 Type	订货号 Part Number
M20	H3A-SF-1L-M20	19200031250
PG11	H3A-SF-1L-PG11	09200031250
PG13.5	H3A-SF-1L-PG13.5	09200031251
底部封闭 Bottom closed		
M20	H3A.BC-SF-1L-M20	19200031252
PG11	H3A.BC-SF-1L-PG11	09200031252
PG13.5	H3A.BC-SF-1L-PG13.5	09200031253

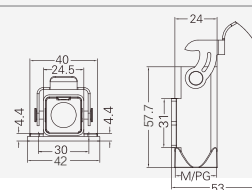

飞线下壳 Housings, cable to cable



螺纹 Thread	型号 Type	订货号 Part Number
M20	H3A-CCT-1L-M20	19200031750
PG11	H3A-CCT-1L-PG11	09200031750
PG13.5	H3A-CCT-1L-PG13.5	09200031751

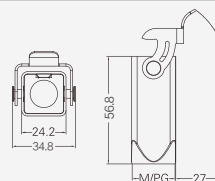



3A 金属外壳(EMC) Metal Hoods & Housings

防护等级 Degree of protection : IP65

上壳 侧出线 Hoods, side entry



螺纹 Thread	型号 Type	订货号 Part Number
M20	EMC.H3A-SE-2B-M20	19620031640
PG11	EMC.H3A-SE-2B-PG11	09620031640

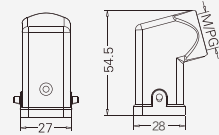

上壳 顶出线 Hoods, top entry



螺纹 Thread	型号 Type	订货号 Part Number
M20	EMC.H3A-TE-2B-M20	19620031440
PG11	EMC.H3A-TE-2B-PG11	09620031440

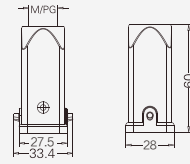

不封底下壳 Housings, bulkhead mounting



螺纹 Thread	型号 Type	订货号 Part Number
---	EMC.H3A-BK-1L	09620030301

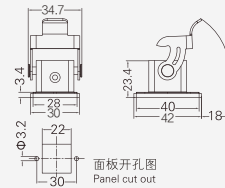

不封底下壳 Housings, bulkhead mounting



螺纹 Thread	型号 Type	订货号 Part Number
---	EMC.H3A-BK-1L-MCV/M (配公芯 for male insert)	09620030305
---	EMC.H3A-BK-1L-MCV/F (配母芯 for female insert)	09620030306

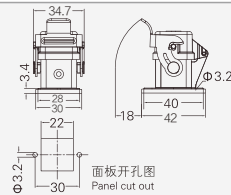

不封底下壳 Housings, bulkhead mounting



螺纹 Thread	型号 Type	订货号 Part Number
---	EMC.H3A-BK-1L-SE	09620030801

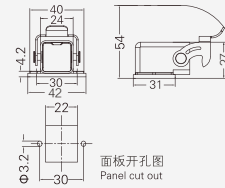

封底下壳 Housings, surface mounting



螺纹 Thread	型号 Type	订货号 Part Number
M20	EMC.H3A-SF-1L-M20	19620031250
PG11	EMC.H3A-SF-1L-PG11	09620031250

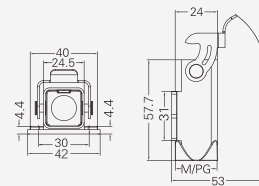

飞线下壳 Housings, cable to cable



螺纹 Thread	型号 Type	订货号 Part Number
M20	EMC.H3A-CCT-1L-M20	19620031750
PG11	EMC.H3A-CCT-1L-PG11	09620031750

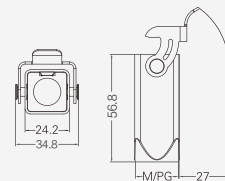



Global District Limited

3A 金属外壳 Metal Hoods & Housings

防护等级 Degree of protection : IP65

防护盖 Protection covers



接线方式 Connect way	型号 Type	订货号 Part Number
	H3A-MCV-1L/1M (配公芯 for male insert)	09200035422
	H3A-MCV-1L/1F (配母芯 for female insert)	09200035421

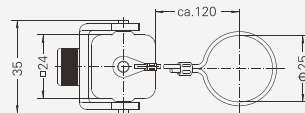

防护盖 Protection covers



接线方式 Connect way	型号 Type	订货号 Part Number
	H3A-MCV-2B/1M (配公芯 for male insert)	09200035426
	H3A-MCV-2B/2M (配公芯 for male insert)	09200035425
	H3A-MCV-2B/1F (配母芯 for female insert)	09200035428
	H3A-MCV-2B/2F (配母芯 for female insert)	09200035427

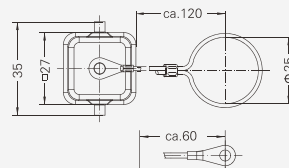

上壳 顶出线 Hoods, top entry

NEW



螺纹 Thread	型号 Type	订货号 Part Number
M25	H3A-TE-2B-M25	19200031441

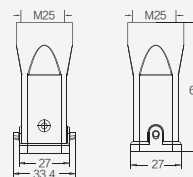



3A 高防护外壳 Pressure tight Hoods & Housings

喷涂/镀铬 Epoxy power paint/Chromated 防护等级 Degree of protection: IP68 H version

上壳 顶出线 Hoods, top entry



螺纹 Thread	型号 Type	订货号 Part Number
	喷涂·螺栓联锁 Epoxy power paint · Screw locking	
M20	HP3A/H-TE-2S-M20	19407030410
PG13.5	HP3A/H-TE-2S-PG13.5	09407030302
	喷涂·轴销联锁 Epoxy power paint · Toggle locking	
M20	HP3A/H-TE-2T-M20	19407030400
PG13.5	HP3A/H-TE-2T-PG13.5	09407030402
	镀铬·螺栓联锁 Chromated · Screw locking	
M20	C.HP3A/H-TE-2S-M20	19400030410
PG13.5	C.HP3A/H-TE-2S-PG13.5	09400030302
	镀铬·轴销联锁 Chromated · Toggle locking	
M20	C.HP3A/H-TE-2T-M20	19400030400
PG13.5	C.HP3A/H-TE-2T-PG13.5	09400030402

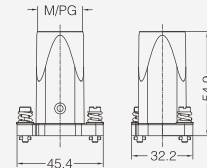

不封底下壳 Housings, bulkhead mounting\*



螺纹 Thread	型号 Type	订货号 Part Number
	喷涂·螺栓联锁 Epoxy power paint · Screw locking	
---	HP3A/H-BK-2H	09407030311
	喷涂·轴销联锁 Epoxy power paint · Toggle locking	
---	HP3A/H-BK-2T	09407030301
	镀铬·螺栓联锁 Chromated · Screw locking	
---	C.HP3A/H-BK-2H	09400030311
	镀铬·轴销联锁 Chromated · Toggle locking	
---	C.HP3A/H-BK-2T	09400030301

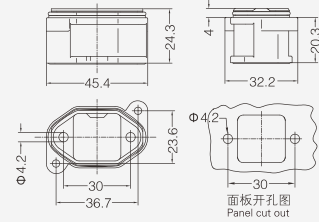

适配器 适用不封底下壳 Adaptor for Housings\*



螺纹 Thread	型号 Type	订货号 Part Number
	喷涂 Epoxy power paint	
---	HP3A/H-BK-SE	09407030902
	镀铬 Chromated	
---	C.HP3A/H-BK-SE	09400030902

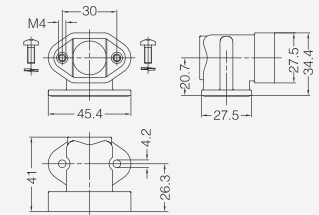

封底下壳 Housings, surface mounting



螺纹 Thread	型号 Type	订货号 Part Number
	喷涂·螺栓联锁 Epoxy power paint · Screw locking	
M20	HP3A/H-SF-2H-M20	19407030950
PG13.5	HP3A/H-SF-2H-PG13.5	09407030502
	镀铬·螺栓联锁 Chromated · Screw locking	
M20	C.HP3A/H-SF-2H-M20	19400030950
PG13.5	C.HP3A/H-SF-2H-PG13.5	09407030602

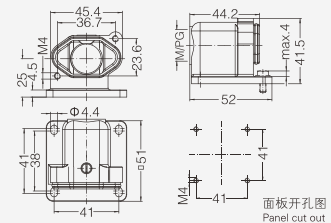

不封底下壳 Housings, bulkhead mounting



螺纹 Thread	型号 Type	订货号 Part Number
	喷涂·螺栓联锁 Epoxy power paint · Screw locking	
---	HP3A/H-SF-2H	09407030950
	镀铬·螺栓联锁 Chromated · Screw locking	
---	C.HP3A/H-SF-2H	09400030950

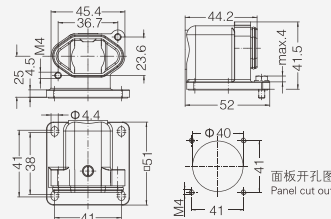



**Global District Limited**
**3A 高防护外壳 Pressure tight Hoods & Housings**
**喷涂/镀铬 Epoxy power paint/Chromated 防护等级 Degree of protection: IP68 H version**

上壳 顶出线 高结构 Hoods, top entry, high construction

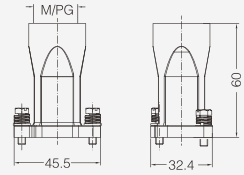

螺纹 Thread	型号 Type	订货号 Part Number
M25	喷涂·螺栓联锁 Epoxy power paint·Screw locking HP3A/H-TEH-2S-M25	19407030411
M25	喷涂·轴销联锁 Epoxy power paint·Toggle locking HP3A/H-TEH-2T-M25	19407030500
M25	镀铬·螺栓联锁 Chromated·Screw locking C.HP3A/H-TEH-2S-M25	19400030411
M25	镀铬·轴销联锁 Chromated·Toggle locking C.HP3A/H-TEH-2T-M25	19400030500



防护盖 Protection covers

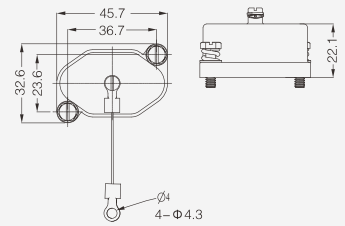

接线方式 Connect way	型号 Type	订货号 Part Number
---	喷涂·螺栓联锁 Epoxy power paint·Screw locking HP3A/H-MCV-2S	09407030501
	HP3A/H-MCV-2S/2S	09407030601
—	喷涂·轴销联锁 Epoxy power paint·Toggle locking HP3A/H-MCV-2T	09407030301
	HP3A/H-MCV-2T/2S	09407030701
---	镀铬·螺栓联锁 Chromated·Screw locking C.HP3A/H-MCV-2S	09400030501
	C.HP3A/H-MCV-2S/2S	09400030601
---	镀铬·轴销联锁 Chromated·Toggle locking C.HP3A/H-MCV-2T	09400030301
	C.HP3A/H-MCV-2T/2S	09400030701

**防护等级 Degree of protection: IP68**
**W version**

上壳 顶出线 Hoods, top entry



螺纹 Thread	型号 Type	订货号 Part Number
M20	HP3A-TE-2S-M20	19407031440
PG11	HP3A-TE-2S-PG11	09407031440

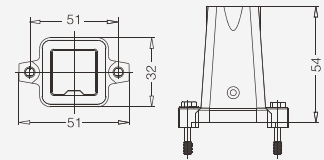

不封底下壳 Housings, bulkhead mounting



螺纹 Thread	型号 Type	订货号 Part Number
---	HP3A-BK-2H	09407030308

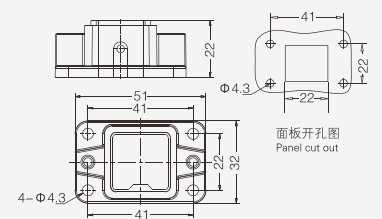





10A 金属外壳 Metal Hoods & Housings

防护等级 Degree of protection: IP65

上壳 侧出线 Hoods, side entry



螺纹 Thread	型号 Type	订货号 Part Number
M20	H10A-SE-2B-M20	19200101540
PG16	H10A-SE-2B-PG16	09200101541

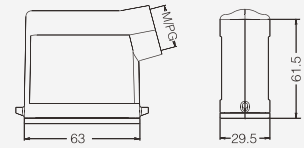

上壳 侧出线 高结构 Hoods, side entry, high construction



螺纹 Thread	型号 Type	订货号 Part Number
M25	H10A-SEH-2B-M25	19200100546
PG16	H10A-SEH-2B-PG16	09200100540
PG21	H10A-SEH-2B-PG21	09200100541

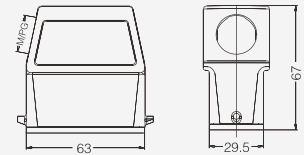

上壳 顶出线 Hoods, top entry



螺纹 Thread	型号 Type	订货号 Part Number
M20	H10A-TE-2B-M20	19200101440
PG13.5	H10A-TE-2B-PG13.5	09200101440

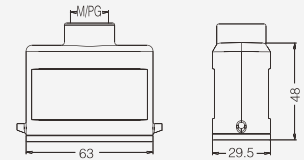

上壳 顶出线 高结构 Hoods, top entry, high construction



螺纹 Thread	型号 Type	订货号 Part Number
M25	H10A-TEH-2B-M25	19200100446
PG16	H10A-TEH-2B-PG16	09200100440
PG21	H10A-TEH-2B-PG21	09200100441

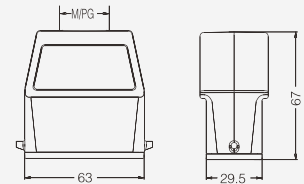

不封底下壳 Housings, bulkhead mounting



螺纹 Thread	型号 Type	订货号 Part Number
---	H10A-BK-1L	09200100301
---	带塑料盖 With plastic cover	
---	H10A-BK-1L-CV	09200100321
---	带金属盖 With metal cover	
---	H10A-BK-1L-MCV	09200100331

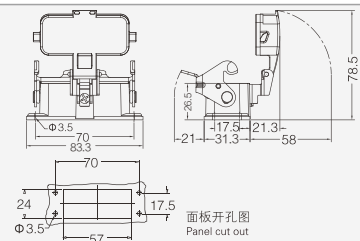



10A 金属外壳 Metal Hoods & Housings

防护等级 Degree of protection: IP65

封底下壳 Housings, surface mounting



螺纹 Thread	型号 Type	订货号 Part Number
M20	H10A-SF-1L-M20	19200100250
2M20	H10A-SF-1L-2M20	19200100290
M25	H10A-SF-1L-M25	19200100251
PG16	H10A-SF-1L-PG16	09200100251
2PG16	H10A-SF-1L-2PG16	09200100291
PG21	H10A-SF-1L-PG21	09200100252
带塑料盖 With plastic cover		
M20	H10A-SF-1L-CV-M20	19200100294
2M20	H10A-SF-1L-CV-2M20	19200100295
M25	H10A-SF-1L-CV-M25	19200100296
PG16	H10A-SF-1L-CV-PG16	09200100221
2PG16	H10A-SF-1L-CV-2PG16	09200100296
PG21	H10A-SF-1L-CV-PG21	09200100231
带金属盖 With metal cover		
M20	H10A-SF-1L-MCV-M20	19200100694
2M20	H10A-SF-1L-MCV-2M20	19200100695
M25	H10A-SF-1L-MCV-M25	19200100696
PG16	H10A-SF-1L-MCV-PG16	09200100651
2PG16	H10A-SF-1L-MCV-2PG16	09200100691
PG21	H10A-SF-1L-MCV-PG21	09200100652

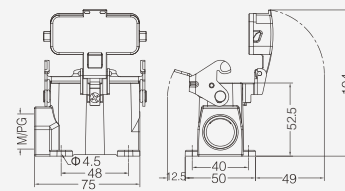

防护盖 Protection covers



接线方式 Connect way	描述 Applications	型号 Type	订货号 Part Number
	金属盖/用于上壳 For hoods	H10A-MCV-1L.1	09200105423

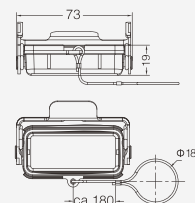

防护盖 Protection covers



接线方式 Connect way	描述 Applications	型号 Type	订货号 Part Number
	金属盖/用于下壳 For housings	H10A-MCV-2B/1S	09200105424
	金属盖/用于下壳 For housings	H10A-MCV-2B/2S	09200105425

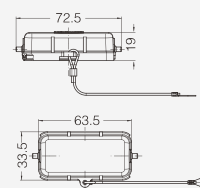



16A 金属外壳 Metal Hoods & Housings

防护等级 Degree of protection: IP65

上壳 侧出线 Hoods, side entry



螺纹 Thread	型号 Type	订货号 Part Number
M20	H16A-SE-2B-M20	19200161540
PG16	H16A-SE-2B-PG16	09200161541

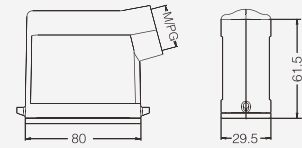

上壳 侧出线 高结构 Hoods, side entry, high construction



螺纹 Thread	型号 Type	订货号 Part Number
M25	H16A-SEH-2B-M25	19200160546
PG16	H16A-SEH-2B-PG16	09200160540
PG21	H16A-SEH-2B-PG21	09200160541

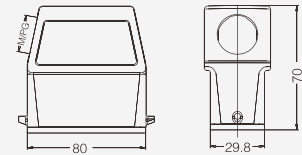

上壳 顶出线 Hoods, top entry



螺纹 Thread	型号 Type	订货号 Part Number
M20	H16A-TE-2B-M20	19200161440
PG16	H16A-TE-2B-PG16	09200161440

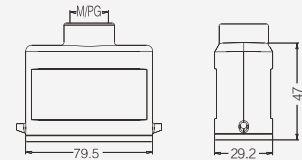

上壳 顶出线 高结构 Hoods, top entry, high construction



螺纹 Thread	型号 Type	订货号 Part Number
M25	H16A-TEH-2B-M25	19200160446
PG16	H16A-TEH-2B-PG16	09200160440
PG21	H16A-TEH-2B-PG21	09200160441

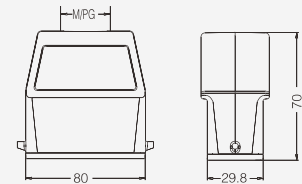

不封底下壳 Housings, bulkhead mounting



螺纹 Thread	型号 Type	订货号 Part Number
---	H16A-BK-1L	09200160301
---	带塑料盖 With plastic cover	
---	H16A-BK-1L-CV	09200160321
---	带金属盖 With metal cover	
---	H16A-BK-1L-MCV	09200160331

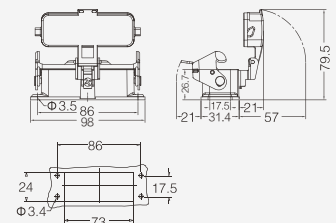



16A 金属外壳 Metal Hoods & Housings

防护等级 Degree of protection: IP65

封底下壳 Housings, surface mounting

螺纹 Thread	型号 Type	订货号 Part Number
M20	H16A-SF-1L-M20	19200161250
2M20	H16A-SF-1L-2M20	09200160290
M25	H16A-SF-1L-M25	19200160251
2M25	H16A-SF-1L-2M25	09200160291
PG16	H16A-SF-1L-PG16	09200160251
2PG16	H16A-SF-1L-2PG16	09200160291
PG21	H16A-SF-1L-PG21	09200160252
带塑料盖 With plastic cover		
M20	H16A-SF-1L-CV-M20	19200160294
2M20	H16A-SF-1L-CV-2M20	19200160295
M25	H16A-SF-1L-CV-M25	19200160296
2M25	H16A-SF-1L-CV-2M25	19200160297
PG16	H16A-SF-1L-CV-PG16	09200160221
2PG16	H16A-SF-1L-CV-2PG16	09200160296
PG21	H16A-SF-1L-CV-PG21	09200160222
带金属盖 With metal cover		
M20	H16A-SF-1L-MCV-M20	19200160694
2M20	H16A-SF-1L-MCV-2M20	19200160695
M25	H16A-SF-1L-MCV-M25	19200160696
2M25	H16A-SF-1L-MCV-2M25	19200160697
PG16	H16A-SF-1L-MCV-PG16	09200160651
2PG16	H16A-SF-1L-MCV-2PG16	09200160691
PG21	H16A-SF-1L-MCV-PG21	09200160652

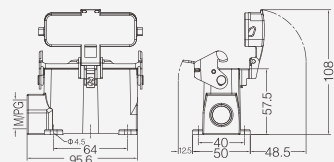

防护盖 Protection covers

接线方式 Connect way	描述 Applications	型号 Type	订货号 Part Number
	金属盖/用于上壳 For hoods	H16A-MCV-1L.1	09200165423

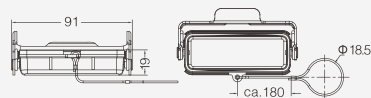

防护盖 Protection covers

接线方式 Connect way	描述 Applications	型号 Type	订货号 Part Number
	金属盖/用于下壳 For housings	H16A-MCV-2B/1S	09200165424
	金属盖/用于下壳 For housings	H16A-MCV-2B/2S	09200165425

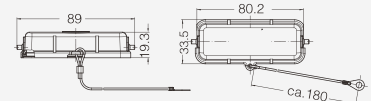



32A 金属外壳 Metal Hoods & Housings

防护等级 Degree of protection: IP65

上壳 侧出线 Hoods, side entry



螺纹 Thread	型号 Type	订货号 Part Number
M25	H32A-SE-4B-M25	19200321521
PG21	H32A-SE-4B-PG21	09200321520

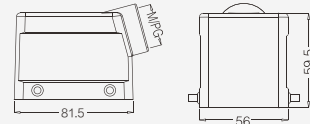

上壳 侧出线 高结构 Hoods, side entry, high construction



螺纹 Thread	型号 Type	订货号 Part Number
M32	H32A-SEH-4B-M32	19200320527
PG21	H32A-SEH-4B-PG21	09200320520
PG29	H32A-SEH-4B-PG29	09200320521

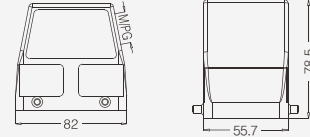

上壳 顶出线 高结构 Hoods, top entry, high construction



螺纹 Thread	型号 Type	订货号 Part Number
M25	H32A-TEH-4B-M25	19200320426
M32	H32A-TEH-4B-M32	19200320427
PG21	H32A-TEH-4B-PG21	09200320420
PG29	H32A-TEH-4B-PG29	09200320421

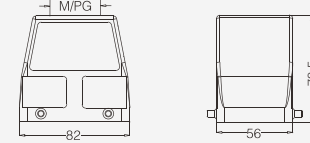

不封底下壳 Housings, bulkhead mounting



螺纹 Thread	型号 Type	订货号 Part Number
---	H32A-BK-2L	09200320301

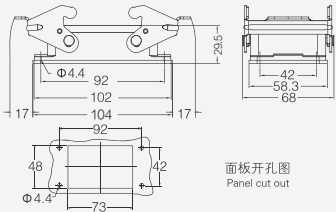

封底下壳 Housings, surface mounting



螺纹 Thread	型号 Type	订货号 Part Number
M25	H32A-SF-2L-M25	19200320231
M32	H32A-SF-2L-M32	19200320232
2M32	H32A-SF-2L-2M32	19200320272
PG21	H32A-SF-2L-PG21	09200320230
2PG21	H32A-SF-2L-2PG21	09200320270
PG29	H32A-SF-2L-PG29	09200320231
2PG29	H32A-SF-2L-2PG29	09200320271

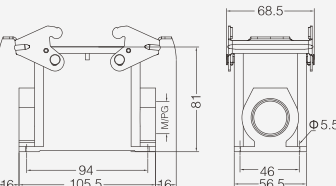

塑料防护盖 4卡扣 Protection covers, plastic cover 4 clamps



接线方式 Connect way	描述 Applications	型号 Type	订货号 Part Number
	用于上壳 for hoods	H32A-CV-4C	09200328001

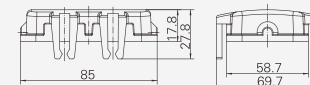

塑料防护盖 Protection covers, plastic cover



接线方式 Connect way	描述 Applications	型号 Type	订货号 Part Number
	用于电缆对接 For housings	H32A-CV-4B/1	09200328030
	用于下壳 For housings	H32A-CV-4B/2	09200328031

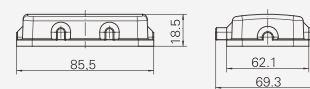



Global District Limited

## 32A 金属外壳 Metal Hoods & Housings

### 防护等级 Degree of protection: IP65

#### 上壳 侧出线 Hoods, side entry



螺纹 Thread	型号 Type	订货号 Part Number
M25	H32A-SE-2L-M25	19200321531
PG21	H32A-SE-2L-PG21	09200321530

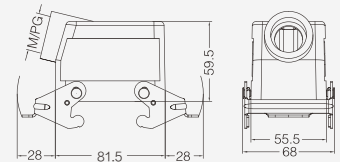

#### 上壳 侧出线 高结构 Hoods, side entry, high construction



螺纹 Thread	型号 Type	订货号 Part Number
M32	H32A-SEH-2L-M32	19200320537
PG21	H32A-SEH-2L-PG21	09200320530
PG29	H32A-SEH-2L-PG29	09200320531

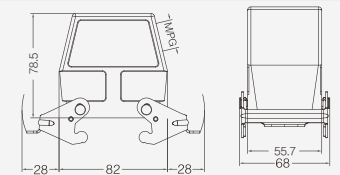

#### 上壳 顶出线 高结构 Hoods, top entry, high construction



螺纹 Thread	型号 Type	订货号 Part Number
M25	H32A-TEH-2L-M25	19200320447
M32	H32A-TEH-2L-M32	19200320437
PG21	H32A-TEH-2L-PG21	09200320430
PG29	H32A-TEH-2L-PG29	09200320431

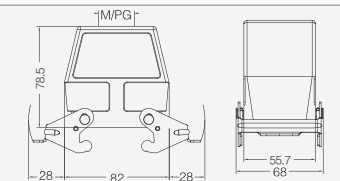

#### 不封底下壳 Housings, bulkhead mounting



螺纹 Thread	型号 Type	订货号 Part Number
---	H32A-BK-4B	09200320202
---	带塑料盖 With plastic cover	
---	H32A-BK-4B-CV	09200320302
---	带金属盖 With metal cover	
---	H32A-BK-4B-MCV	09200320402

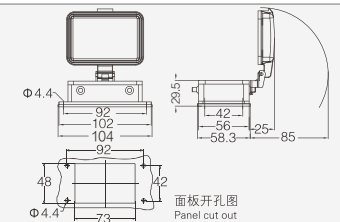

#### 封底下壳 Housings, surface mounting



螺纹 Thread	型号 Type	订货号 Part Number
M25	H32A-SF-4B-M25	19200320251
M32	H32A-SF-4B-M32	19200320258
2M32	H32A-SF-4B-2M32	19200320298
PG21	H32A-SF-4B-PG21	09200320252
2PG21	H32A-SF-4B-2PG21	09200320292
PG29	H32A-SF-4B-PG29	09200320253
2PG29	H32A-SF-4B-2PG29	09200320293
	带塑料盖 With plastic cover	
M25	H32A-SF-4B-CV-M25	19200320226
M32	H32A-SF-4B-CV-M32	19200320227
2M32	H32A-SF-4B-CV-2M32	19200320267
PG21	H32A-SF-4B-CV-PG21	09200320220
2PG21	H32A-SF-4B-CV-2PG21	09200320260
PG29	H32A-SF-4B-CV-PG29	09200320221
2PG29	H32A-SF-4B-CV-2PG29	09200320261
	带金属盖 With metal cover	
M25	H32A-SF-4B-MCV-M25	19200320696
M32	H32A-SF-4B-MCV-M32	19200320698
2M32	H32A-SF-4B-MCV-2M32	19200320699
PG21	H32A-SF-4B-MCV-PG21	09200320652
2PG21	H32A-SF-4B-MCV-2PG21	09200320692
PG29	H32A-SF-4B-MCV-PG29	09200320653
2PG29	H32A-SF-4B-MCV-2PG29	09200320693

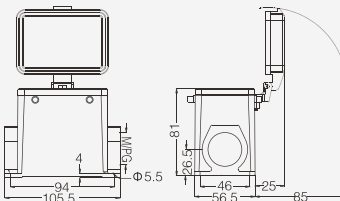



6B 塑料外壳 Plastic Hoods & Housings

防护等级 Degree of protection : IP65

上壳 侧出线 高结构 Hoods, side entry, high construction



螺纹 Thread	型号 Type	订货号 Part Number
M25	H6B.P-SEH-4B-M25	19300060110
M32	H6B.P-SEH-4B-M32	19300060111

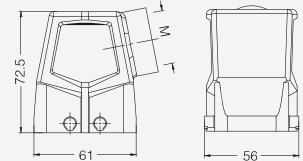

上壳 顶出线 高结构 Hoods, top entry, high construction



螺纹 Thread	型号 Type	订货号 Part Number
M25	H6B.P-TEH-4B-M25	19300060120
M32	H6B.P-TEH-4B-M32	19300060121

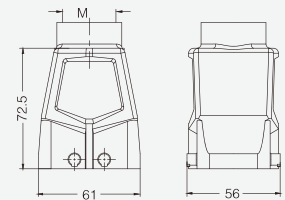

不封底下壳 Housings, bulkhead mounting



螺纹 Thread	型号 Type	订货号 Part Number
---	H6B.P-BK-2L	09300060300

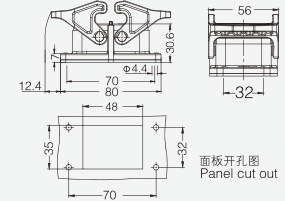

封底下壳 高结构 Housings, surface mounting, high construction



螺纹 Thread	型号 Type	订货号 Part Number
M25	H6B.P-SFH-2L-M25	19300060131
2M25	H6B.P-SFH-2L-2M25	19300060135
M32	H6B.P-SFH-2L-M32	19300060132
2M32	H6B.P-SFH-2L-2M32	19300060136

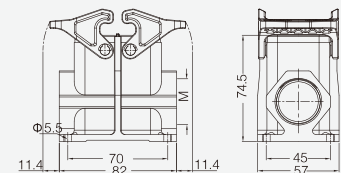

防护盖 Protection covers



螺纹 Thread	型号 Type	订货号 Part Number
---	H6B.P-CV-4B/2	09300060140

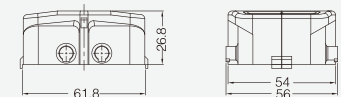

防护盖 Protection covers



螺纹 Thread	型号 Type	订货号 Part Number
---	H6B.P-CV-2L/1	09300060145

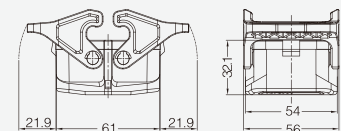



6B 金属外壳 Metal Hoods & Housings

防护等级 Degree of protection : IP65

上壳 侧出线 Hoods, side entry



螺纹 Thread	型号 Type	订货号 Part Number
M20	H6B-SE-2B-M20	19300061540
M25	H6B-SE-2B-M25	19300061541
PG13.5	H6B-SE-2B-PG13.5	09300061540
PG16	H6B-SE-2B-PG16	09300061541

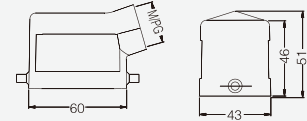

上壳 侧出线 高结构 Hoods, side entry, high construction



螺纹 Thread	型号 Type	订货号 Part Number
M25	H6B-SEH-2B-M25	19300060546
M32	H6B-SEH-2B-M32	19300060547
PG21	H6B-SEH-2B-PG21	09300060542
PG29	H6B-SEH-2B-PG29	09300060543

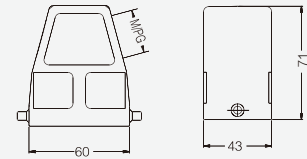

上壳 顶出线 Hoods, top entry



螺纹 Thread	型号 Type	订货号 Part Number
M20	H6B-TE-2B-M20	19300061440
M25	H6B-TE-2B-M25	19300061441
PG13.5	H6B-TE-2B-PG13.5	09300061440
PG16	H6B-TE-2B-PG16	09300061441

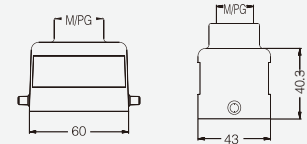

上壳 顶出线 高结构 Hoods, top entry, high construction



螺纹 Thread	型号 Type	订货号 Part Number
M20	H6B-TEH-2B-M20	19300060445
M25	H6B-TEH-2B-M25	19300060446
M32	H6B-TEH-2B-M32	19300060447
PG16	H6B-TEH-2B-PG16	09300060441
PG21	H6B-TEH-2B-PG21	09300060442
PG29	H6B-TEH-2B-PG29	09300060443

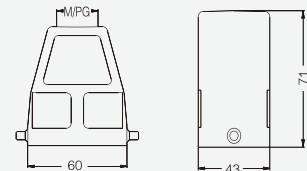

我司可提供顶部、侧面同时出线的非标品, 详见P15-04  
We can provide non-standard products with both top&side entry, see P15-04

飞线下壳 Housings, cable to cable



螺纹 Thread	型号 Type	订货号 Part Number
M20	H6B-CCT-1L-M20	19300061750
PG13.5	H6B-CCT-1L-PG13.5	09300061750
PG16	H6B-CCT-1L-PG16	09300061751

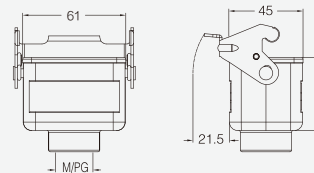

飞线下壳 高结构 Housings, cable to cable, high construction



螺纹 Thread	型号 Type	订货号 Part Number
M25	H6B-CCTH-1L-M25	19300060756
PG21	H6B-CCTH-1L-PG21	09300060752
PG29	H6B-CCTH-1L-PG29	09300060753

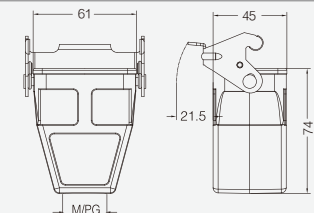





Global District Limited

6B 金属外壳 Metal Hoods & Housings

防护等级 Degree of protection : IP65

不封底下壳 Housings, bulkhead mounting



螺纹 Thread	型号 Type	订货号 Part Number
---	H6B-BK-1L	09300060301
	带塑料盖 With plastic cover	
---	H6B-BK-1L-CV	09300060302
	带金属料盖 With metal cover	
---	H6B-BK-1L-MCV	09300060318

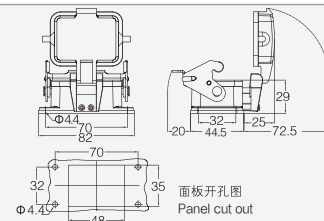

封底下壳 Housings, surface mounting



螺纹 Thread	型号 Type	订货号 Part Number
M20	6B-SF-1L-M20	19300061250
2M20	H6B-SF-1L-2M20	19300061290
M25	H6B-SF-1L-M25	19300061350
2M25	H6B-SF-1L-2M25	19300061390
PG16	H6B-SF-1L-PG16	09300061251
2PG16	H6B-SF-1L-2PG16	09300061291
	带塑料盖 With plastic cover	
M20	H6B-SF-1L-CV-M20	19300061255
2M20	H6B-SF-1L-CV-2M20	19300061295
M25	H6B-SF-1L-CV-M25	19300061355
2M25	H6B-SF-1L-CV-2M25	19300061395
PG16	H6B-SF-1L-CV-PG16	09300061256
2PG16	H6B-SF-1L-CV-2PG16	09300061296
	带金属盖 With metal cover	
M20	H6B-SF-1L-MCV-M20	19300062255
2M20	H6B-SF-1L-MCV-2M20	19300062295
M25	H6B-SF-1L-MCV-M25	19300062355
2M25	H6B-SF-1L-MCV-2M25	19300062395
PG16	H6B-SF-1L-MCV-PG16	09300062256
2PG16	H6B-SF-1L-MCV-2PG16	09300062296

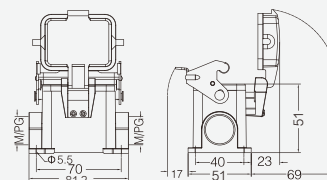

封底下壳 高结构 Housings, surface mounting, high construction



螺纹 Thread	型号 Type	订货号 Part Number
M25	H6B-SFH-1L-M25	19300060251
2M25	H6B-SFH-1L-2M25	19300060291
M32	H6B-SFH-1L-M32	19300060252
2M32	H6B-SFH-1L-2M32	19300060292
PG21	H6B-SFH-1L-PG21	09300060252
2PG21	H6B-SFH-1L-2PG21	09300060292
PG29	H6B-SFH-1L-PG29	09300060253
2PG29	H6B-SFH-1L-2PG29	09300060293
	带塑料盖 With plastic cover	
M25	H6B-SFH-1L-CV-M25	19300060256
2M25	H6B-SFH-1L-CV-2M25	19300060296
M32	H6B-SFH-1L-CV-M32	19300060257
2M32	H6B-SFH-1L-CV-2M32	19300060297
PG21	H6B-SFH-1L-CV-PG21	09300060257
2PG21	H6B-SFH-1L-CV-2PG21	09300060297
PG29	H6B-SFH-1L-CV-PG29	09300060258
2PG29	H6B-SFH-1L-CV-2PG29	09300060298
	带金属盖 With metal cover	
M25	H6B-SFH-1L-MCV-M25	19300067256
2M25	H6B-SFH-1L-MCV-2M25	19300067296
M32	H6B-SFH-1L-MCV-M32	19300061257
2M32	H6B-SFH-1L-MCV-2M32	19300061297
PG21	H6B-SFH-1L-MCV-PG21	09300062257
2PG21	H6B-SFH-1L-MCV-2PG21	09300062297
PG29	H6B-SFH-1L-MCV-PG29	09300062258
2PG29	H6B-SFH-1L-MCV-2PG29	09300062298

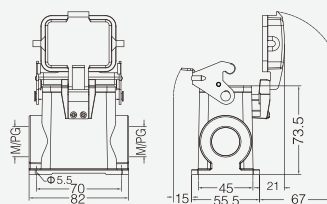



6B 金属外壳 Metal Hoods & Housings

防护等级 Degree of protection : IP65

防护盖 Protection covers, plastic



接线方式 Connect way	描述 Applications	型号 Type	订货号 Part Number
---	塑料盖 For hoods	H6B-CV-2C	09300065420

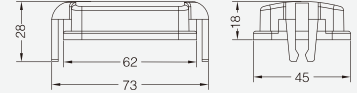

防护盖 Protection covers, metal



接线方式 Connect way	描述 Applications	型号 Type	订货号 Part Number
	金属盖/用于上壳 For hoods	H6B-MCV-2B/1	09300065427
	金属盖/用于下壳 For housings	H6B-MCV-2B/2	09300065425

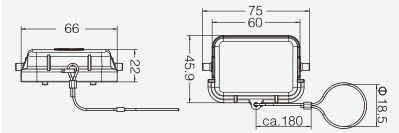

防护盖 Protection covers, metal



接线方式 Connect way	描述 Applications	型号 Type	订货号 Part Number
	金属盖/用于上壳 For hoods	H6B-MCV-1L.1S	09300065423

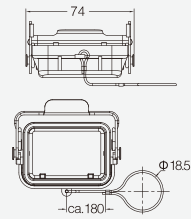

上壳侧出线/顶出线 高结构 Hoods,side&top entry,high construction



型号为:H6B-SEH/TEH-2B-XX/XX  
如有需要请与我司联系



**Global District Limited**

6B 金属外壳 适用于苛刻环境(耐腐蚀) Metal Hoods & Housings For higher environmental requirements

防护等级 Degree of protection : IP65

上壳 侧出线 Hoods, side entry



螺纹 Thread	型号 Type	订货号 Part Number
M20	H6B-MSE-2B-M20	19370061540
PG13.5	H6B-MSE-2B-PG13.5	09370061540

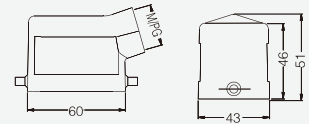

上壳 侧出线 高结构 Hoods, side entry, high construction



螺纹 Thread	型号 Type	订货号 Part Number
M25	H6B-MSEH-2B-M25	19370060546
PG21	H6B-MSEH-2B-PG21	09370060542

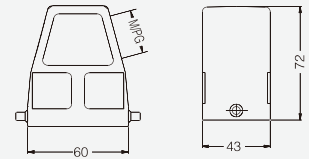

上壳 顶出线 Hoods, top entry



螺纹 Thread	型号 Type	订货号 Part Number
M20	H6B-MTE-2B-M20	19370061440
PG13.5	H6B-MTE-2B-PG13.5	09370061440
PG16	H6B-MTE-2B-PG16	09370061441

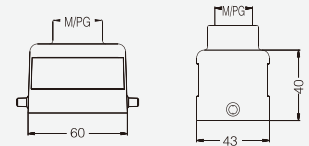

上壳 顶出线 高结构 Hoods, top entry, high construction



螺纹 Thread	型号 Type	订货号 Part Number
M25	H6B-MTEH-2B-M25	19370060446

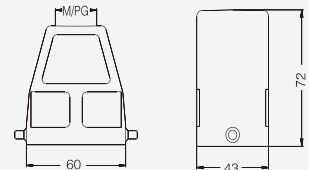

飞线下壳 Housings, cable to cable



螺纹 Thread	型号 Type	订货号 Part Number
PG13.5	H6B-MCCT-1L-PG13.5	09370061750

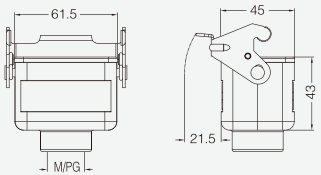



**Global District Limited**

6B 金属外壳 适用于苛刻环境(耐腐蚀) Metal Hoods & Housings For higher environmental requirements

防护等级 Degree of protection : IP65

上壳 侧出线 Hoods, side entry



螺纹 Thread	型号 Type	订货号 Part Number
---	H6B-MBK-1L	09370060301
	带金属盖 With metal cover	
---	H6B-MBK-1L-MMCV	09370060318

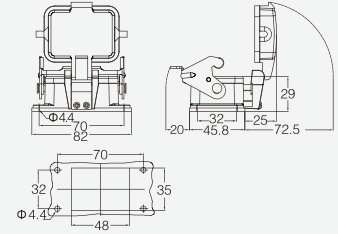

封底下壳 Housings, surface mounting



螺纹 Thread	型号 Type	订货号 Part Number
2PG16	H6B-MSF-1L-2PG16	09370061291
2M20	H6B-MSF-1L-2M20	19370061290

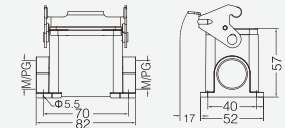

防护盖 Protection covers



螺纹 Thread	型号 Type	订货号 Part Number
M25	H6B-MMCV-2B/1	09370065407
	H6B-MMCV-2B/2	09370065405

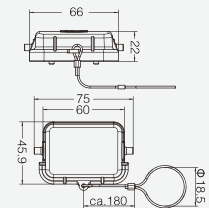



6B 高防护外壳 Hoods & Housings for harsh environmental requirements

防护等级 Degree of protection : IP68

W version

上壳 侧出线 高结构 Hoods, side entry, high construction



螺纹 Thread	型号 Type	订货号 Part Number
M20	HP6B-SEH-2S-M20	19400060210
M25	HP6B-SEH-2S-M25	19400060211
M32	HP6B-SEH-2S-M32	19400060212
PG16	HP6B-SEH-2S-PG16	09400060211
PG21	HP6B-SEH-2S-PG21	09400060212

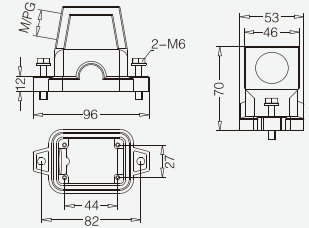

上壳 顶出线 高结构 Hoods, top entry, high construction



螺纹 Thread	型号 Type	订货号 Part Number
M20	HP6B-TEH-2S-M20	19400060220
M25	HP6B-TEH-2S-M25	19400060221
M32	HP6B-TEH-2S-M32	19400060222
PG16	HP6B-TEH-2S-PG16	09400060221
PG21	HP6B-TEH-2S-PG21	09400060222
PG29	HP6B-TEH-2S-PG29	09400060223

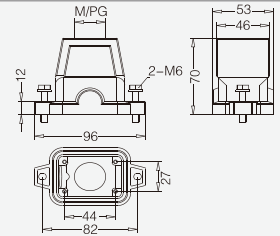

封底下壳 高结构 Housings, surface mounting, high construction



螺纹 Thread	型号 Type	订货号 Part Number
M20	HP6B-SFH-2H-M20	19400060230
M25	HP6B-SFH-2H-M25	19400060231
M32	HP6B-SFH-2H-M32	19400060232
PG16	HP6B-SFH-2H-PG16	09400060231
PG21	HP6B-SFH-2H-PG21	09400060232

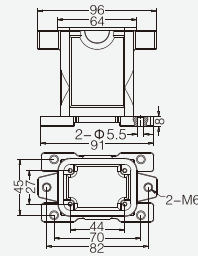

不封底下壳 Housings, bulkhead mounting



螺纹 Thread	型号 Type	订货号 Part Number
---	HP6B-BK-2H	09400060201

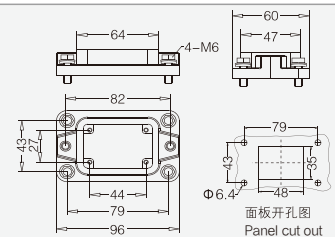



6B 高防护外壳 Hoods & Housings for harsh environmental requirements

防护等级 Degree of protection : IP68

H version

上壳 侧出线 高结构 Hoods, side entry, high construction



螺纹 Thread	型号 Type	订货号 Part Number
	螺栓联锁 Screw locking	
M20	HP6B/H-SEH-2S-M20	19400060510
M25	HP6B/H-SEH-2S-M25	19400060511
M32	HP6B/H-SEH-2S-M32	19400060512
PG16	HP6B/H-SEH-2S-PG16	09400060511
PG21	HP6B/H-SEH-2S-PG21	09400060512
PG29	HP6B/H-SEH-2S-PG29	09400060513
	轴销联锁 Toggle locking	
M20	HP6B/H-SEH-2T-M20	19400060500
M25	HP6B/H-SEH-2T-M25	19400060501
M32	HP6B/H-SEH-2T-M32	19400060502
PG16	HP6B/H-SEH-2T-PG16	09400060501
PG21	HP6B/H-SEH-2T-PG21	09400060502

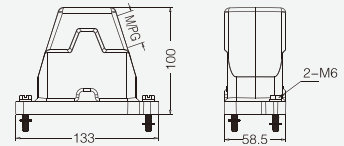

上壳 顶出线 高结构 Hoods, top entry, high construction



螺纹 Thread	型号 Type	订货号 Part Number
	螺栓联锁 Screw locking	
M20	HP6B/H-TEH-2S-M20	19400060410
M25	HP6B/H-TEH-2S-M25	19400060411
M32	HP6B/H-TEH-2S-M32	19400060412
PG16	HP6B/H-TEH-2S-PG16	09400060411
PG21	HP6B/H-TEH-2S-PG21	09400060412
PG29	HP6B/H-TEH-2S-PG29	09400060413
	轴销联锁 Toggle locking	
M20	HP6B/H-TEH-2T-M20	19400060400
M25	HP6B/H-TEH-2T-M25	19400060401
M32	HP6B/H-TEH-2T-M32	19400060402
PG16	HP6B/H-TEH-2T-PG16	09400060401
PG21	HP6B/H-TEH-2T-PG21	09400060402
PG29	HP6B/H-TEH-2T-PG29	09400060403

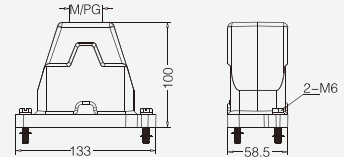

封底下壳 高结构 Housings, surface mounting, high construction



螺纹 Thread	型号 Type	订货号 Part Number
	螺栓联锁 Screw locking	
M20	HP6B/H-SFH-2H-M20	19400061260
M25	HP6B/H-SFH-2H-M25	19400061261
M32	HP6B/H-SFH-2H-M32	19400061262
PG16	HP6B/H-SFH-2H-PG16	09400061260
PG21	HP6B/H-SFH-2H-PG21	09400061261
PG29	HP6B/H-SFH-2H-PG29	09400061262
	轴销联锁 Toggle locking	
M20	HP6B/H-SFH-2T-M20	19400061270
M25	HP6B/H-SFH-2T-M25	19400061271
M32	HP6B/H-SFH-2T-M32	19400061272
PG16	HP6B/H-SFH-2T-PG16	09400061270
PG21	HP6B/H-SFH-2T-PG21	09400061271
PG29	HP6B/H-SFH-2T-PG29	09400061272

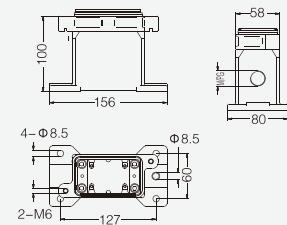



6B 高防护外壳 Hoods & Housings for harsh environmental requirements

防护等级 Degree of protection : IP68

H version

不封底下壳 Housings, bulkhead mounting



螺纹 Thread	型号 Type	订货号 Part Number
---	螺栓联锁 Screw locking HP6B/H-BK-2H	09400060311
---	轴销联锁 Toggle locking HP6B/H-BK-2T	09400060301
---	带金属盖 With metal cover 螺栓联锁 Screw locking HP6B/H-BK-2H-MCV	09400060317
---	轴销联锁 Toggle locking HP6B/H-BK-2T-MCV	09400060307

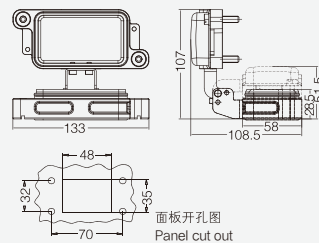

防护盖 Protection covers



螺纹 Thread	型号 Type	订货号 Part Number
---	螺栓联锁 Screw locking HP6B/H-MCV-2S	09400065411
---	轴销联锁 Toggle locking HP6B/H-MCV-2T	09400065401

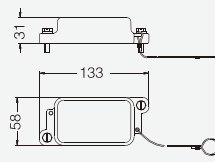

上壳 侧出线 高结构 Hoods, side entry, high construction



螺纹 Thread	型号 Type	订货号 Part Number
M20	HP6B/H-SEH-4S-M20	19400061360
M25	HP6B/H-SEH-4S-M25	19400061361
M32	HP6B/H-SEH-4S-M32	19400061362
M40	HP6B/H-SEH-4S-M40	19400061363
PG16	HP6B/H-SEH-4S-PG16	09400061361
PG21	HP6B/H-SEH-4S-PG21	09400061362

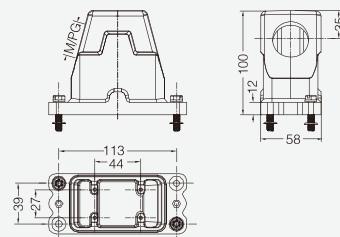

上壳 顶出线 高结构 Hoods, top entry, high construction



螺纹 Thread	型号 Type	订货号 Part Number
M20	HP6B/H-TEH-4S-M20	19400061460
M25	HP6B/H-TEH-4S-M25	19400061461
M32	HP6B/H-TEH-4S-M32	19400061462
M40	HP6B/H-TEH-4S-M40	19400061463
PG16	HP6B/H-TEH-4S-PG16	09400061461
PG21	HP6B/H-TEH-4S-PG21	09400061462
PG29	HP6B/H-TEH-4S-PG29	09400061463

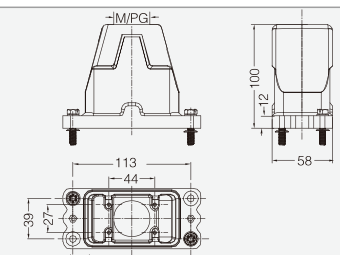

不封底下壳 Housings, bulkhead mounting



螺纹 Thread	型号 Type	订货号 Part Number
---	HP6B/H-BK-4H	09400060202

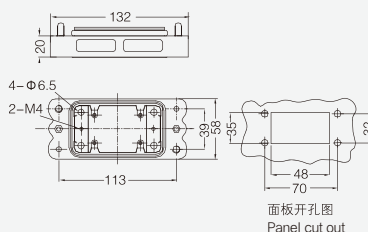



6B 高防护外壳 Hoods & Housings for harsh environmental requirements

防护等级 Degree of protection : IP68

上壳 侧出线 高结构 Hoods, side entry, high construction



螺纹 Thread	型号 Type	订货号 Part Number
M20	HC6B-SEH-2S-M20	19400061500
M25	HC6B-SEH-2S-M25	19400061501
PG16	HC6B-SEH-2S-PG16	09400061500
PG21	HC6B-SEH-2S-PG21	09400061501

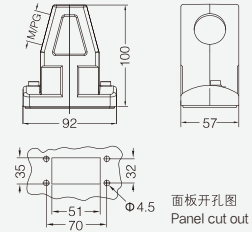

上壳 顶出线 高结构 Hoods, top entry, high construction



螺纹 Thread	型号 Type	订货号 Part Number
M20	HC6B-TEH-2S-M20	19400061550
M25	HC6B-TEH-2S-M25	19400061551
PG16	HC6B-TEH-2S-PG16	09400061550
PG21	HC6B-TEH-2S-PG21	09400061551

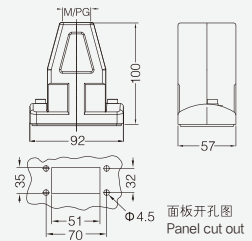

芯体安装支块 Protection covers



描述 Application	型号 Type	订货号 Part Number
整体型外壳适配 For integral type hoods	APT-C	09400061600

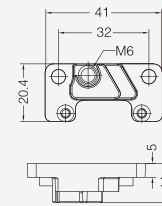





**Global District Limited**
**10B 塑料外壳 Plastic Hoods & Housings**
**防护等级 Degree of protection : IP65**

上壳 侧出线 高结构 Hoods, side entry, high construction

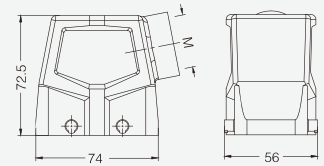

螺纹 Thread	型号 Type	订货号 Part Number
M25	H10B.P-SEH-4B-M25	19300100110
M32	H10B.P-SEH-4B-M32	19300100111



上壳 顶出线 高结构 Hoods, top entry, high construction



螺纹 Thread	型号 Type	订货号 Part Number
M25	H10B.P-TEH-4B-M25	19300100120
M32	H10B.P-TEH-4B-M32	19300100121

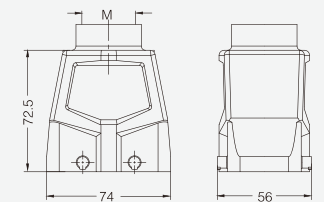

不封底下壳 Housings, bulkhead mounting



螺纹 Thread	型号 Type	订货号 Part Number
---	H10B.P-BK-2L	09300100300

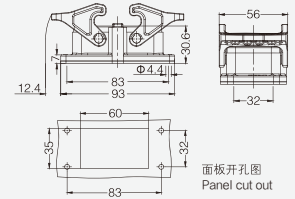

封底下壳 高结构 Housings, surface mounting, high construction



螺纹 Thread	型号 Type	订货号 Part Number
M25	H10B.P-SFH-2L-M25	19300100131
2M25	H10B.P-SFH-2L-2M25	19300100135
M32	H10B.P-SFH-2L-M32	19300100132
2M32	H10B.P-SFH-2L-2M32	19300100136

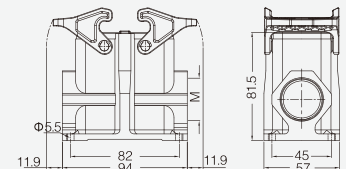

防护盖 Protection covers



螺纹 Thread	型号 Type	订货号 Part Number
---	H10B.P-CV-4B/2	09300100140

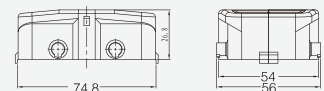

防护盖 Protection covers



螺纹 Thread	型号 Type	订货号 Part Number
---	H10B.P-CV-2L/1	09300100145

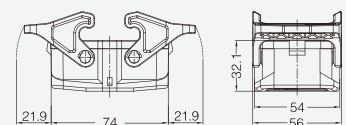



10B 金属外壳 Metal Hoods & Housings

防护等级 Degree of protection : IP65

上壳 侧出线 Hoods, side entry



螺纹 Thread	型号 Type	订货号 Part Number
M20	H10B-SE-2B-M20	19300101540
M25	H10B-SE-2B-M25	19300101541
PG16	H10B-SE-2B-PG16	09300101541

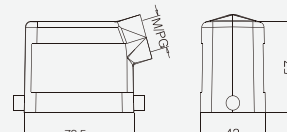

上壳 侧出线 高结构 Hoods, side entry, high construction



螺纹 Thread	型号 Type	订货号 Part Number
M25	H10B-SEH-2B-M25	19300100546
M32	H10B-SEH-2B-M32	19300100547
PG21	H10B-SEH-2B-PG21	09300100542
PG29	H10B-SEH-2B-PG29	09300100543

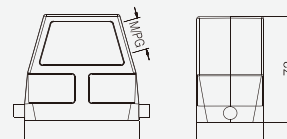

上壳 顶出线 Hoods, top entry



螺纹 Thread	型号 Type	订货号 Part Number
M20	H10B-TE-2B-M20	19300101440
M25	H10B-TE-2B-M25	19300101441
PG16	H10B-TE-2B-PG16	09300101441

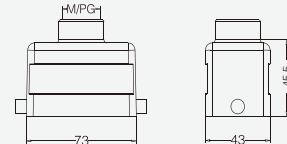

上壳 顶出线 高结构 Hoods, top entry, high construction



螺纹 Thread	型号 Type	订货号 Part Number
M25	H10B-TEH-2B-M25	19300100446
M32	H10B-TEH-2B-M32	19300100447
PG21	H10B-TEH-2B-PG21	09300100442
PG29	H10B-TEH-2B-PG29	09300100443

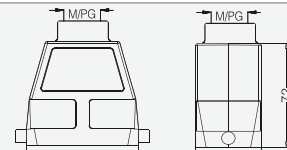

飞线下壳 Housings, cable to cable



螺纹 Thread	型号 Type	订货号 Part Number
M20	H10B-CCT-1L-M20	19300101750
PG16	H10B-CCT-1L-PG16	09300101751

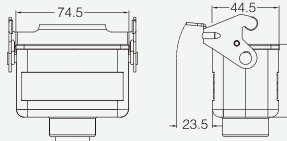

飞线下壳 高结构 Housings, cable to cable, high construction



螺纹 Thread	型号 Type	订货号 Part Number
M25	H10B-CCTH-1L-M25	19300100756
M32	H10B-CCTH-1L-M32	19300100757
PG21	H10B-CCTH-1L-PG21	09300100752
PG29	H10B-CCTH-1L-PG29	09300100753

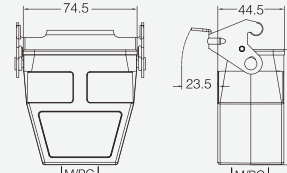

不封底下壳 Housings, bulkhead mounting



螺纹 Thread	型号 Type	订货号 Part Number
---	H10B-BK-SE-1L(82-68-4.5)	09300100901
---	H10B-BK-SE-1L(82-70-4.5)	09300100961
---	H10B-BK-SE-1L(85-73-4.5)	09304100921
---	H10B-BK-SE-1L(85-73-5.5)	09304100971
---	H10B-BK-SE-1L(92-70-4.1)	09628100974
---	H10B-BK-SE-1L(92-70-4.3)	09304100974
---	H10B-BK-SE-1L(92-77-4.3)	09304100970
---	H10B-BK-SE-1L(92-80-5.1)	09304100983
---	H10B-BK-SE-1L(98-70-4.3)	09304100960
---	H10B-BK-SE-1L(98-68-4.5)	09304100909

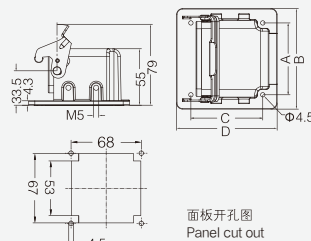



**Global District Limited**
**10B 金属外壳 Metal Hoods & Housings**
**防护等级 Degree of protection : IP65**

不封底下壳 Housings, bulkhead mounting

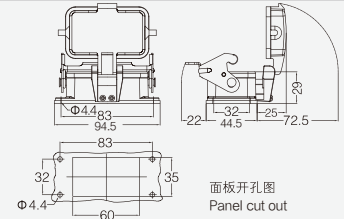

螺纹 Thread	型号 Type	订货号 Part Number
---	H10B-BK-1L 带塑料盖 With plastic cover	09300100305
---	H10B-BK-1L-CV 带金属料盖 With metal cover	09300100303
---	H10B-BK-1L-MCV	09300100318



封底下壳 Housings, surface mounting



螺纹 Thread	型号 Type	订货号 Part Number
M20	H10B-SF-1L-M20	19300101250
2M20	H10B-SF-1L-2M20	19300101290
M25	H10B-SF-1L-M25	19300101251
2M25	H10B-SF-1L-2M25	19300101291
PG16	H10B-SF-1L-PG16	09300101251
2PG16	H10B-SF-1L-2PG16 带塑料盖 With plastic cover	09300101291
M20	H10B-SF-1L-CV-M20	19300101255
2M20	H10B-SF-1L-CV-2M20	19300101295
M25	H10B-SF-1L-CV-M25	19300101256
2M25	H10B-SF-1L-CV-2M25	19300101296
PG16	H10B-SF-1L-CV-PG16	09300101256
2PG16	H10B-SF-1L-CV-2PG16 带金属盖 With metal cover	09300101296
M20	H10B-SF-1L-MCV-M20	19300102255
2M20	H10B-SF-1L-MCV-2M20	19300102295
M25	H10B-SF-1L-MCV-M25	19300102256
2M25	H10B-SF-1L-MCV-2M25	19300102296
PG16	H10B-SF-1L-MCV-PG16	09300102256
2PG16	H10B-SF-1L-MCV-2PG16	09300102296

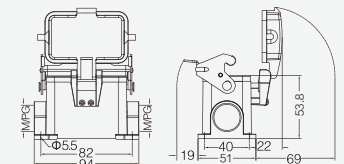

封底下壳 高结构 Housings, surface mounting, high construction



螺纹 Thread	型号 Type	订货号 Part Number
M25	H10B-SFH-1L-M25	19300100291
2M25	H10B-SFH-1L-2M25	19300100391
M32	H10B-SFH-1L-M32	19300100292
2M32	H10B-SFH-1L-2M32	19300100392
PG21	H10B-SFH-1L-PG21	09300100192
2PG21	H10B-SFH-1L-2PG21	09300100292
PG29	H10B-SFH-1L-PG29	09300100193
2PG29	H10B-SFH-1L-2PG29 带塑料盖 With plastic cover	09300100293
M25	H10B-SFH-1L-CV-M25	19300100196
2M25	H10B-SFH-1L-CV-2M25	19300100296
M32	H10B-SFH-1L-CV-M32	19300100197
2M32	H10B-SFH-1L-CV-2M32	19300100297
PG21	H10B-SFH-1L-CV-PG21	09300100197
2PG21	H10B-SFH-1L-CV-2PG21	09300100297
PG29	H10B-SFH-1L-CV-PG29	09300100198
2PG29	H10B-SFH-1L-CV-2PG29 带金属盖 With metal cover	09300100298
M25	H10B-SFH-1L-MCV-M25	19300107295
2M25	H10B-SFH-1L-MCV-2M25	19300107296
M32	H10B-SFH-1L-MCV-M32	19300107297
2M32	H10B-SFH-1L-MCV-2M32	19300107298
PG21	H10B-SFH-1L-MCV-PG21	09300102197
2PG21	H10B-SFH-1L-MCV-2PG21	09300102297
PG29	H10B-SFH-1L-MCV-PG29	09300102198
2PG29	H10B-SFH-1L-MCV-2PG29	09300102298

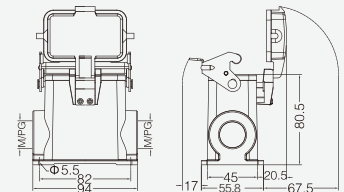



10B 金属外壳 Metal Hoods & Housings

防护等级 Degree of protection : IP65

上壳 侧出线 Hoods, side entry



螺纹 Thread	型号 Type	订货号 Part Number
M20	H10B-SE-4B-M20	19300101520
M25	H10B-SE-4B-M25	19300101521
PG16	H10B-SE-4B-PG16	09300101521

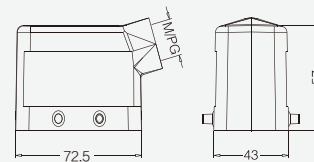

上壳 侧出线 高结构 Hoods, side entry, high construction



螺纹 Thread	型号 Type	订货号 Part Number
M25	H10B-SEH-4B-M25	19300100526
M32	H10B-SEH-4B-M32	19300100527
PG21	H10B-SEH-4B-PG21	09300100522
PG29	H10B-SEH-4B-PG29	09300100523

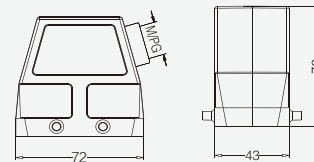

我司可提供顶部、侧面同时出线的非标品, 详见P16-06  
We can provide non-standard products with both top&side entry, see P16-06

上壳 顶出线 Hoods, top entry



螺纹 Thread	型号 Type	订货号 Part Number
M20	H10B-TE-4B-M20	19300101420
M25	H10B-TE-4B-M25	19300101421
PG16	H10B-TE-4B-PG16	09300101421

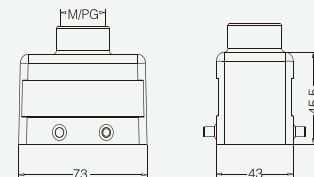

上壳 顶出线 高结构 Hoods, top entry, high construction



螺纹 Thread	型号 Type	订货号 Part Number
M25	H10B-TEH-4B-M25	19300100426
M32	H10B-TEH-4B-M32	19300100427
2M20	H10B-TEH-4B-2M20	19300100465
PG16	H10B-TEH-4B-PG16	09300100421
PG21	H10B-TEH-4B-PG21	09300100422
Pg29	H10B-TEH-4B-PG29	09300100423

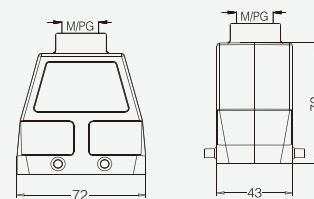

不封底下壳 Housings, bulkhead mounting



螺纹 Thread	型号 Type	订货号 Part Number
---	H10B-BK-2L	09300100301

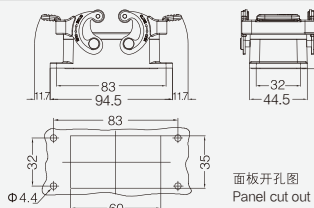

封底下壳 Housings, surface mounting



螺纹 Thread	型号 Type	订货号 Part Number
M20	H10B-SF-2L-M20	19300101230
2M20	H10B-SF-2L-2M20	19300101270
M25	H10B-SF-2L-M25	19300101231
2M25	H10B-SF-2L-2M25	19300101271
PG16	H10B-SF-2L-PG16	09300101231
2PG16	H10B-SF-2L-2PG16	09300101271

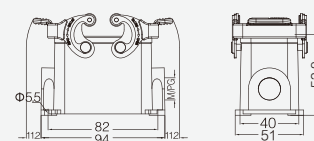



10B 金属外壳 Metal Hoods & Housings

防护等级 Degree of protection : IP65

封底下壳 高结构 Housings, surface mounting, high construction



螺纹 Thread	型号 Type	订货号 Part Number
M25	H10B-SFH-2L-M25	19300100231
2M25	H10B-SFH-2L-2M25	19300100271
M32	H10B-SFH-2L-M32	19300100232
2M32	H10B-SFH-2L-2M32	19300100272
PG21	H10B-SFH-2L-PG21	09300100232
2PG21	H10B-SFH-2L-2PG21	09300100272
PG29	H10B-SFH-2L-PG29	09300100233
2PG29	H10B-SFH-2L-2PG29	09300100273

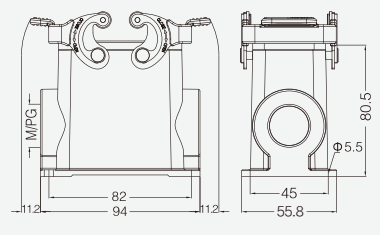

飞线下壳 Housings, cable to cable



螺纹 Thread	型号 Type	订货号 Part Number
M20	H10B-CCT-2L-M20	19300101730
PG16	H10B-CCT-2L-PG16	09300101731

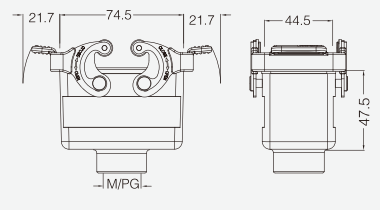

飞线下壳 高结构 Housings, cable to cable, high construction



螺纹 Thread	型号 Type	订货号 Part Number
M25	H10B-CCTH-2L-M25	19300100736
M32	H10B-CCTH-2L-M32	19300100737
PG21	H10B-CCTH-2L-PG21	09300100732
PG29	H10B-CCTH-2L-PG29	09300100733

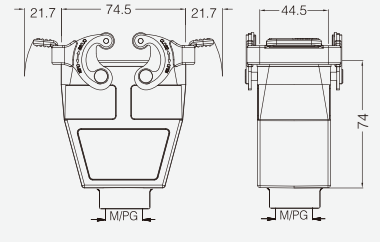

塑料防护盖 Protection covers, plastic



接线方式 Connect way	描述 Applications	型号 Type	订货号 Part Number
---	用于上壳 For hoods	H10B-CV-4C	09300105401

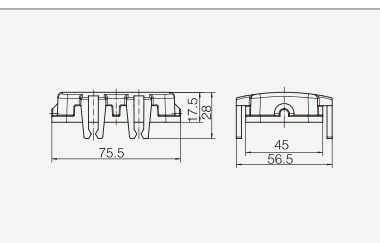

塑料防护盖 Protection covers, Plastic



接线方式 Connect way	描述 Applications	型号 Type	订货号 Part Number
	塑料盖/用于飞线下壳 For Housings, cable to cable	H10B-CV-4B/1	09300105426
	塑料盖/用于不封底,封底下壳 For housing, bulkhead/ surface mounting	H10B-CV-4B/2	09300105428

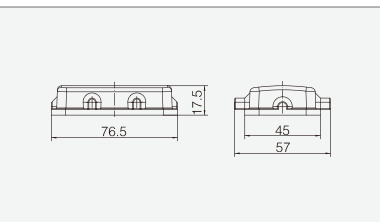



10B 金属外壳 Metal Hoods & Housings

防护等级 Degree of protection : IP65

上壳 侧出线 Hoods, side entry



螺纹 Thread	型号 Type	订货号 Part Number
M20	H10B-SE-2L-M20	19300101530
PG16	H10B-SE-2L-PG16	09300101531

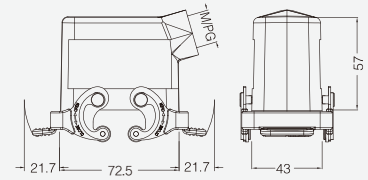

上壳 侧出线 高结构 Hoods, side entry, high construction



螺纹 Thread	型号 Type	订货号 Part Number
M25	H10B-SEH-2L-M25	19300100536
M32	H10B-SEH-2L-M32	19300100537
PG21	H10B-SEH-2L-PG21	09300100532
PG29	H10B-SEH-2L-PG29	09300100533

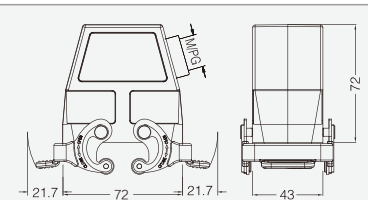

上壳 顶出线 Hoods, top entry



螺纹 Thread	型号 Type	订货号 Part Number
M20	H10B-TE-2L-M20	19300101430
PG16	H10B-TE-2L-PG16	09300101431

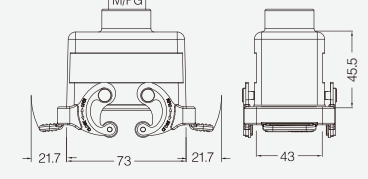

上壳 顶出线 高结构 Hoods, top entry, high construction



螺纹 Thread	型号 Type	订货号 Part Number
M25	H10B-TEH-2L-M25	19300100436
M32	H10B-TEH-2L-M32	19300100437
PG21	H10B-TEH-2L-PG21	09300100432
PG29	H10B-TEH-2L-PG29	09300100433

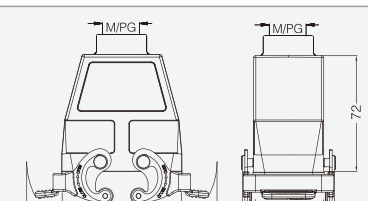

不封底下壳 Housings, bulkhead mounting



螺纹 Thread	型号 Type	订货号 Part Number
---	H10B-BK-4B	09300100300
---	带塑料盖 With plastic cover	
---	H10B-BK-4B-CV	09300100302
---	带金属盖 With metal cover	
---	H10B-BK-4B-MCV	09300100317

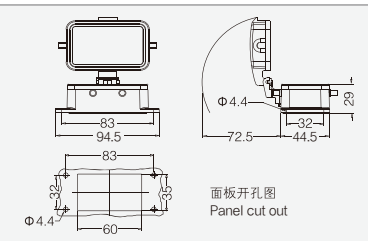

上壳侧出线/顶出线 高结构 Hoods,side&top entry,high construction



型号为:H10B-SEH/TEH-4B-XX/XX  
如有需要请与我司联系



10B 金属外壳 Metal Hoods & Housings

防护等级 Degree of protection : IP65

封底下壳 Housings, surface mounting



螺纹 Thread	型号 Type	订货号 Part Number
M20	H10B-SF-4B-M20	19300101125
2M20	H10B-SF-4B-2M20	19300101165
M25	H10B-SF-4B-M25	19300101126
2M25	H10B-SF-4B-2M25	19300101166
PG16	H10B-SF-4B-PG16	09300101121
2PG16	H10B-SF-4B-2PG16	09300101161
带塑料盖 With plastic cover		
M20	H10B-SF-4B-CV-M20	19300101225
2M20	H10B-SF-4B-CV-2M20	19300101265
M25	H10B-SF-4B-CV-M25	19300101226
2M25	H10B-SF-4B-CV-2M25	19300101266
PG16	H10B-SF-4B-CV-PG16	09300101221
2PG16	H10B-SF-4B-CV-2PG16	09300101261
带金属盖 With metal cover		
M20	H10B-SF-4B-MCV-M20	19300102225
2M20	H10B-SF-4B-MCV-2M20	19300102265
M25	H10B-SF-4B-MCV-M25	19300102226
2M25	H10B-SF-4B-MCV-2M25	19300102266
PG16	H10B-SF-4B-MCV-PG16	09300102221
2PG16	H10B-SF-4B-MCV-2PG16	09300102261

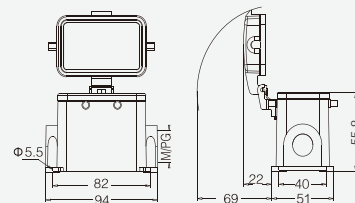

封底下壳 高结构 Housings, surface mounting, high construction



螺纹 Thread	型号 Type	订货号 Part Number
M25	H10B-SFH-4B-M25	19300100126
2M25	H10B-SFH-4B-2M25	19300100166
M32	H10B-SFH-4B-M32	19300100127
2M32	H10B-SFH-4B-2M32	19300100167
PG21	H10B-SFH-4B-PG21	09300100122
2PG21	H10B-SFH-4B-2PG21	09300100162
PG29	H10B-SFH-4B-PG29	09300100123
2PG29	H10B-SFH-4B-2PG29	09300100163
带塑料盖 With plastic cover		
M25	H10B-SFH-4B-CV-M25	19300100226
2M25	H10B-SFH-4B-CV-2M25	19300100266
M32	H10B-SFH-4B-CV-M32	19300100227
2M32	H10B-SFH-4B-CV-2M32	19300100267
PG21	H10B-SFH-4B-CV-PG21	09300100222
2PG21	H10B-SFH-4B-CV-2PG21	09300100262
PG29	H10B-SFH-4B-CV-PG29	09300100223
2PG29	H10B-SFH-4B-CV-2PG29	09300100263
带金属盖 With metal cover		
M25	H10B-SFH-4B-MCV-M25	19300102226
2M25	H10B-SFH-4B-MCV-2M25	19300102266
M32	H10B-SFH-4B-MCV-M32	19300102227
2M32	H10B-SFH-4B-MCV-2M32	19300102267
PG21	H10B-SFH-4B-MCV-PG21	09300102222
2PG21	H10B-SFH-4B-MCV-2PG21	09300102262
PG29	H10B-SFH-4B-MCV-PG29	09300102223
2PG29	H10B-SFH-4B-MCV-2PG29	09300102263

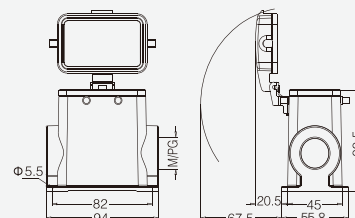

防护盖 Protection covers, metal



接线方式 Connect way	描述 Applications	型号 Type	订货号 Part Number
	金属盖/用于上壳 For hoods	H10B-MCV-4B/1	09300105427
	金属盖/用于下壳 For housings	H10B-MCV-4B/2	09300105425

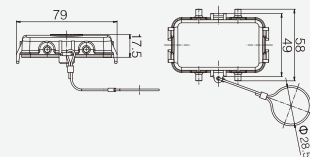

防护盖 Protection covers, metal



接线方式 Connect way	描述 Applications	型号 Type	订货号 Part Number
	金属盖/用于上壳 For hoods	H10B-MCV-2L.1S	09300105423
	金属盖/用于下壳 For housings	H10B-MCV-2L.2S	09300105424

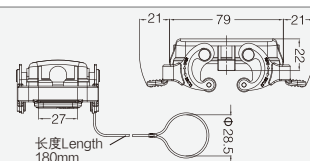



**Global District Limited**

10B 金属外壳 适用于苛刻环境(耐腐蚀) Metal Hoods & Housings For higher environmental requirements

防护等级 Degree of protection : IP65

W version

上壳 侧出线 Hoods, side entry



螺纹 Thread	型号 Type	订货号 Part Number
M20	H10B-MSE-4B-M20	19370101520
PG16	H10B-MSE-4B-PG16	09370101521

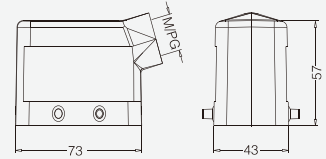

上壳 侧出线 高结构 Hoods, side entry, high construction



螺纹 Thread	型号 Type	订货号 Part Number
M25	H10B-MSEH-4B-M25	19370100526

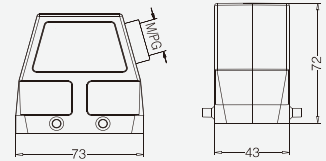

上壳 顶出线 Hoods, top entry



螺纹 Thread	型号 Type	订货号 Part Number
M20	H10B-MTE-4B-M20	19370101420
PG16	H10B-MTE-4B-PG16	09370101421

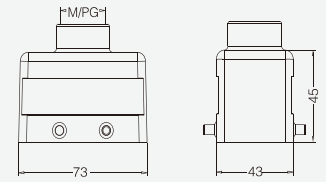

上壳 顶出线 高结构 Hoods, top entry, high construction



螺纹 Thread	型号 Type	订货号 Part Number
M32	H10B-MTEH-4B-M32	19370100427

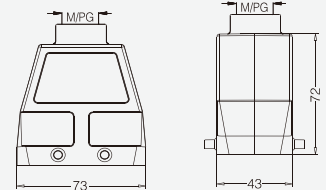

飞线下壳 Housings, cable to cable



螺纹 Thread	型号 Type	订货号 Part Number
PG16	H10B-MCCT-2L-PG16	09370101731

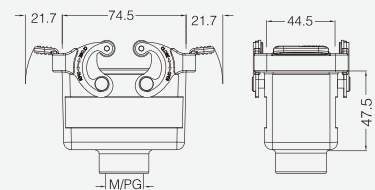

不封底下壳 Housings, bulkhead mounting



螺纹 Thread	型号 Type	订货号 Part Number
---	H10B-MBK-2L	09370100301

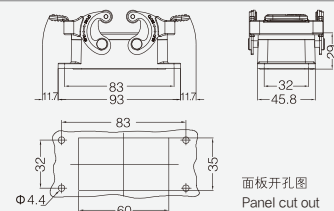





**Global District Limited**

10B 金属外壳 适用于苛刻环境(耐腐蚀) Metal Hoods & Housings For higher environmental requirements

防护等级 Degree of protection : IP65

上壳 侧出线 Hoods, side entry



螺纹 Thread	型号 Type	订货号 Part Number
M20	H10B-MSF-2L-2M20	19370101270
PG16	H10B-MSF-2L-2PG16	09370101271

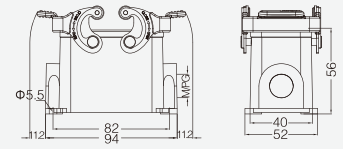

上壳 侧出线 高结构 Hoods, side entry, high construction



螺纹 Thread	型号 Type	订货号 Part Number
M32	H10B-MSFH-2L-2M32	19370100272

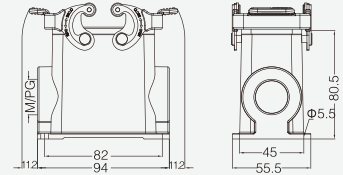

防护盖 Protection covers, metal



螺纹 Thread	型号 Type	订货号 Part Number
---	H10B-MMCV-2L.1S	09370105403

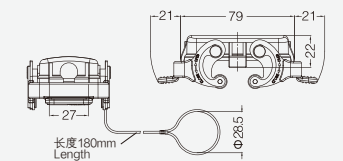

防护盖 Protection covers, metal



螺纹 Thread	型号 Type	订货号 Part Number
---	H10B-MMCV-4B/2	09370105405

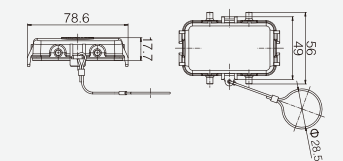

防护等级 Degree of protection : IP65 2耳

上壳 顶出线 高结构 Hoods, top entry, high construction



螺纹 Thread	型号 Type	订货号 Part Number
M32	H10B-MTEH-2B-M32	19370100447

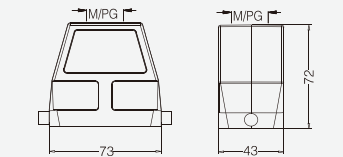

封底下壳 高结构 Housings, surface mounting, high construction



螺纹 Thread	型号 Type	订货号 Part Number
M25	H10B-MSFH-1L-M25	19370100291

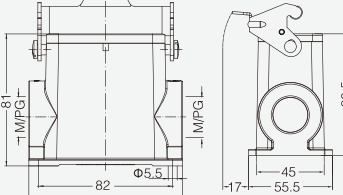



10B 高防护外壳 Hoods & Housings for harsh environmental requirements

防护等级 Degree of protection : IP68

W version

上壳 侧出线 高结构 Hoods, side entry, high construction



螺纹 Thread	型号 Type	订货号 Part Number
M20	HP10B-SEH-2S-M20	19400100210
M25	HP10B-SEH-2S-M25	19400100211
M32	HP10B-SEH-2S-M32	19400100212
PG16	HP10B-SEH-2S-PG16	09400100211
PG21	HP10B-SEH-2S-PG21	09400100212

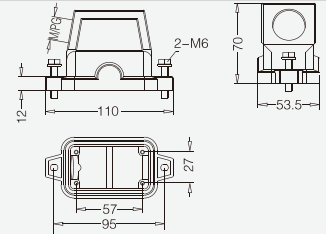

上壳 顶出线 高结构 Hoods, top entry, high construction



螺纹 Thread	型号 Type	订货号 Part Number
M20	HP10B-TEH-2S-M20	19400100220
M25	HP10B-TEH-2S-M25	19400100221
M32	HP10B-TEH-2S-M32	19400100222
PG16	HP10B-TEH-2S-PG16	09400100221
PG21	HP10B-TEH-2S-PG21	09400100222
PG29	HP10B-TEH-2S-PG29	09400100223

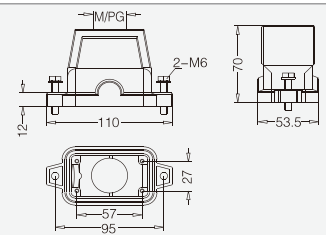

封底下壳 高结构 Housings, surface mounting, high construction



螺纹 Thread	型号 Type	订货号 Part Number
M20	HP10B-SFH-2H-M20	19400100230
M25	HP10B-SFH-2H-M25	19400100231
M32	HP10B-SFH-2H-M32	19400100232
PG16	HP10B-SFH-2H-PG16	09400100231
PG21	HP10B-SFH-2H-PG21	09400100232

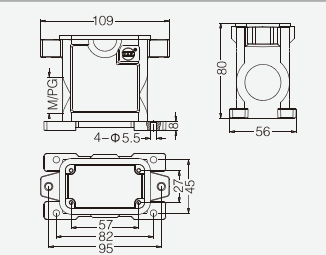

不封底下壳 Housings, bulkhead mounting



螺纹 Thread	型号 Type	订货号 Part Number
---	HP10B-BK-2H	09400100201

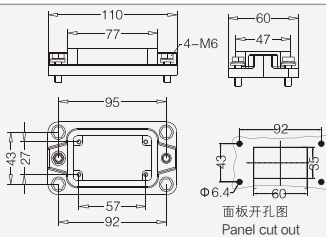



Global District Limited

10B 高防护外壳 Hoods & Housings for harsh environmental requirements

防护等级 Degree of protection : IP68

H version

上壳 侧出线 高结构 Hoods, side entry, high construction



螺纹 Thread	型号 Type	订货号 Part Number
	螺栓联锁 Screw locking	
M20	HP10B/H-SEH-2S-M20	19400100510
M25	HP10B/H-SEH-2S-M25	19400100511
M32	HP10B/H-SEH-2S-M32	19400100512
M40	HP10B/H-SEH-2S-M40	19400100513
PG16	HP10B/H-SEH-2S-PG16	09400100511
PG21	HP10B/H-SEH-2S-PG21	09400100512
PG29	HP10B/H-SEH-2S-PG29	09400100513
	轴销联锁 Toggle locking	
M20	HP10B/H-SEH-2T-M20	19400100500
M25	HP10B/H-SEH-2T-M25	19400100501
M32	HP10B/H-SEH-2T-M32	19400100502
PG16	HP10B/H-SEH-2T-PG16	09400100501
PG21	HP10B/H-SEH-2T-PG21	09400100502
PG29	HP10B/H-SEH-2T-PG29	09400100503

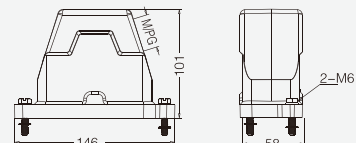

上壳 顶出线 高结构 Hoods, top entry, high construction



螺纹 Thread	型号 Type	订货号 Part Number
	螺栓联锁 Screw locking	
M20	HP10B/H-TEH-2S-M20	19400100410
M25	HP10B/H-TEH-2S-M25	19400100411
M32	HP10B/H-TEH-2S-M32	19400100412
M40	HP10B/H-TEH-2S-M40	19400100413
2M20	HP10B/H-TEH-2S-2M20	19400100430
PG16	HP10B/H-TEH-2S-PG16	09400100411
PG21	HP10B/H-TEH-2S-PG21	09400100412
PG29	HP10B/H-TEH-2S-PG29	09400100413
	轴销联锁 Toggle locking	
M20	HP10B/H-TEH-2T-M20	19400100400
M25	HP10B/H-TEH-2T-M25	19400100401
M32	HP10B/H-TEH-2T-M32	19400100402
PG16	HP10B/H-TEH-2T-PG16	09400100401
PG21	HP10B/H-TEH-2T-PG21	09400100402
PG29	HP10B/H-TEH-2T-PG29	09400100403

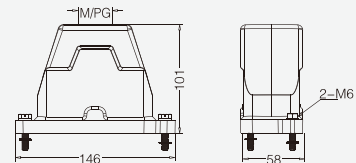

封底下壳 高结构 Housings, surface mounting, high construction



螺纹 Thread	型号 Type	订货号 Part Number
	螺栓联锁 Screw locking	
M20	HP10B/H-SFH-2H-M20	19400101260
M25	HP10B/H-SFH-2H-M25	19400101261
M32	HP10B/H-SFH-2H-M32	19400101262
M40	HP10B/H-SFH-2H-M40	19400101263
2M25	HP10B/H-SFH-2H-2M25	19400101271
2M32	HP10B/H-SFH-2H-2M32	19400101272
PG16	HP10B/H-SFH-2H-PG16	09400101260
PG21	HP10B/H-SFH-2H-PG21	09400101261
PG29	HP10B/H-SFH-2H-PG29	09400101262
	轴销联锁 Toggle locking	
M20	HP10B/H-SFH-2T-M20	19400101280
M25	HP10B/H-SFH-2T-M25	19400101281
M32	HP10B/H-SFH-2T-M32	19400101282
PG16	HP10B/H-SFH-2T-PG16	09400101281
PG21	HP10B/H-SFH-2T-PG21	09400101282
PG29	HP10B/H-SFH-2T-PG29	09400101283

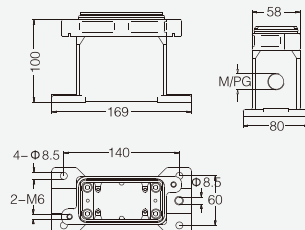



10B 高防护外壳 Hoods & Housings for harsh environmental requirements

防护等级 Degree of protection : IP68

H version

不封底下壳 Housings, bulkhead mounting



螺纹 Thread	型号 Type	订货号 Part Number
---	螺栓联锁 Screw locking HP10B/H-BK-2H	09400100311
---	轴销联锁 Toggle locking HP10B/H-BK-2T	09400100301
---	带金属盖 螺栓联锁 Screw locking HP10B/H-BK-2H-MCV	09400100317
---	轴销联锁 Toggle locking HP10B/H-BK-2T-MCV	09400100307

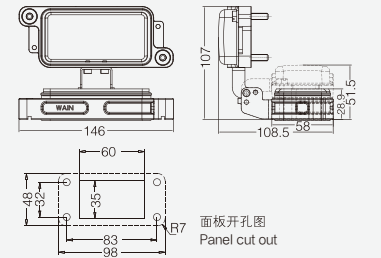

防护盖 Protection covers



螺纹 Thread	型号 Type	订货号 Part Number
---	螺栓联锁 Screw locking HP10B/H-MCV-2S	09400105411
---	轴销联锁 Toggle locking HP10B/H-MCV-2T	09400105401

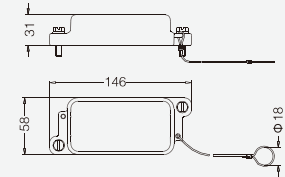

上壳 侧出线 高结构 Hoods, side entry, high construction



螺纹 Thread	型号 Type	订货号 Part Number
M20	HP10B/H-SEH-4S-M20	19400101360
M25	HP10B/H-SEH-4S-M25	19400101361
M32	HP10B/H-SEH-4S-M32	19400101362
M40	HP10B/H-SEH-4S-M40	19400101363
PG16	HP10B/H-SEH-4S-PG16	09400101361
PG21	HP10B/H-SEH-4S-PG21	09400101362

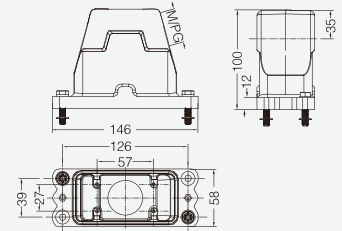

上壳 顶出线 高结构 Hoods, top entry, high construction



螺纹 Thread	型号 Type	订货号 Part Number
M20	HP10B/H-TEH-4S-M20	19400101460
M25	HP10B/H-TEH-4S-M25	19400101461
M32	HP10B/H-TEH-4S-M32	19400101462
M40	HP10B/H-TEH-4S-M40	19400101463
PG16	HP10B/H-TEH-4S-PG16	09400101461
PG21	HP10B/H-TEH-4S-PG21	09400101462
PG29	HP10B/H-TEH-4S-PG29	09400101463

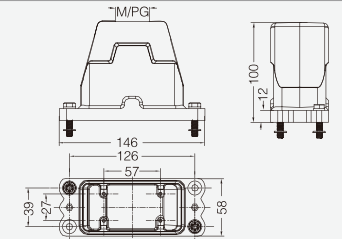

不封底下壳 Housings, bulkhead mounting



螺纹 Thread	型号 Type	订货号 Part Number
---	HP10B/H-BK-4H	09400100202

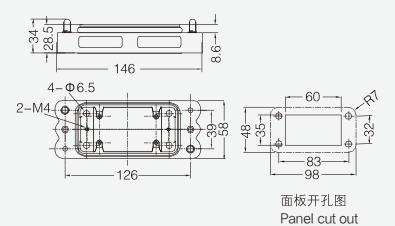



**Global District Limited**

10B 高防护外壳 Hoods & Housings for harsh environmental requirements

防护等级 Degree of protection : IP68

上壳 侧出线 高结构 Hoods, side entry, high construction



螺纹 Thread	型号 Type	订货号 Part Number
M25	HC10B-SEH-2S-M25	19400101500
M32	HC10B-SEH-2S-M32	19400101501
PG16	HC10B-SEH-2S-PG16	09400101500
PG21	HC10B-SEH-2S-PG21	09400101501

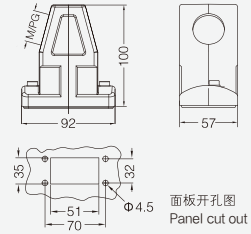

上壳 顶出线 高结构 Hoods, top entry, high construction



螺纹 Thread	型号 Type	订货号 Part Number
M25	HC10B-TEH-2S-M25	19400101550
M32	HC10B-TEH-2S-M32	19400101551
PG16	HC10B-TEH-2S-PG16	09400101550
PG21	HC10B-TEH-2S-PG21	09400101551

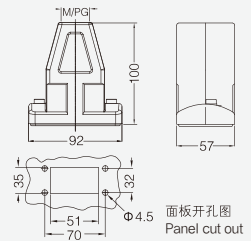

芯体安装支块 Protection covers



描述 Application	型号 Type	订货号 Part Number
整体型外壳适配 For integral type hoods	APT-C	09400101600

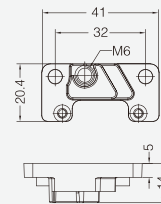



**Global District Limited**

**HV10B 金属外壳 用于高电压插芯 (HVE系列) Metal Hoods & Housings For High Voltage Inserts(HVE Series)**

**防护等级 Degree of protection : IP65**

上壳 侧出线 Hoods, side entry



螺纹 Thread	型号 Type	订货号 Part Number
M20	HV10B-SE-2B-M20	19340101540
PG16	HV10B-SE-2B-PG16	09340101541

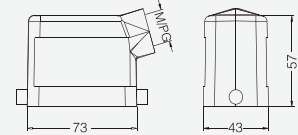

上壳 侧出线 高结构 Hoods, side entry, high construction



螺纹 Thread	型号 Type	订货号 Part Number
M25	HV10B-SEH-2B-M25	19340100546
M32	HV10B-SEH-2B-M32	19340100547
PG21	HV10B-SEH-2B-PG21	09340100542
PG29	HV10B-SEH-2B-PG29	09340100543

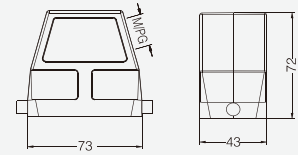

上壳 顶出线 Hoods, top entry



螺纹 Thread	型号 Type	订货号 Part Number
M20	HV10B-TE-2B-M20	19340101440
PG16	HV10B-TE-2B-PG16	09340101441

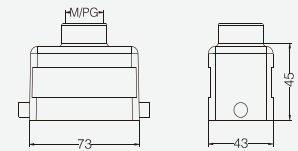

上壳 顶出线 高结构 Hoods, top entry, high construction



螺纹 Thread	型号 Type	订货号 Part Number
M25	HV10B-TEH-2B-M25	19340100446
M32	HV10B-TEH-2B-M32	19340100447
PG21	HV10B-TEH-2B-PG21	09340100442
PG29	HV10B-TEH-2B-PG29	09340100443

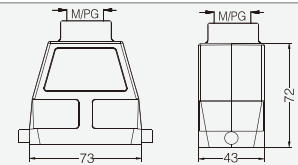

飞线下壳 Housings, cable to cable



螺纹 Thread	型号 Type	订货号 Part Number
M20	HV10B-CCT-1L-M20	19340101750
PG16	HV10B-CCT-1L-PG16	09340101751

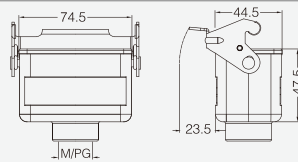

飞线下壳 高结构 Housings, cable to cable, high construction



螺纹 Thread	型号 Type	订货号 Part Number
M25	HV10B-CCTH-1L-M25	19340100756
M32	HV10B-CCTH-1L-M32	19340100757
PG21	HV10B-CCTH-1L-PG21	09340100752
PG29	HV10B-CCTH-1L-PG29	09340100753

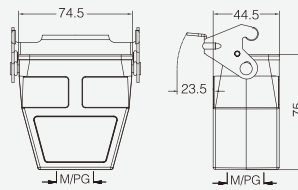



**Global District Limited**

**HV10B 金属外壳 用于高压插芯 ( HVE系列 ) Metal Hoods & Housings- For High Voltage Inserts(HVE Series)**

**防护等级 Degree of protection : IP65**

不封底下壳 Housings, bulkhead mounting



螺纹 Thread	型号 Type	订货号 Part Number
---	HV10B-BK-1L	09340100305
---	带塑料盖 With plastic cover	
---	HV10B-BK-1L-CV	09340100303
---	带金属盖 With metal cover	
---	HV10B-BK-1L-MCV	09340100318

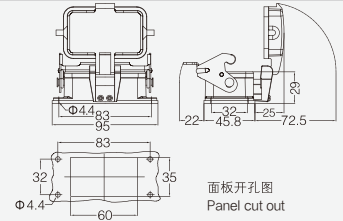

封底下壳 Housings, surface mounting



螺纹 Thread	型号 Type	订货号 Part Number
M20	HV10B-SF-1L-M20	19340101250
2M20	HV10B-SF-1L-2M20	19340101290
M25	HV10B-SF-1L-M25	19340101251
2M25	HV10B-SF-1L-2M25	19340101291
PG16	HV10B-SF-1L-PG16	09340101251
2PG16	HV10B-SF-1L-2PG16	09340101291
	带塑料盖 With plastic cover	
M20	HV10B-SF-1L-CV-M20	19340101255
2M20	HV10B-SF-1L-CV-2M20	19340101295
M25	HV10B-SF-1L-CV-M25	19340101256
2M25	HV10B-SF-1L-CV-2M25	19340101296
PG16	HV10B-SF-1L-CV-PG16	09340101256
2PG16	HV10B-SF-1L-CV-2PG16	09340101296
	带金属盖 With metal cover	
M20	HV10B-SF-1L-MCV-M20	19340102255
2M20	HV10B-SF-1L-MCV-2M20	19340102295
M25	HV10B-SF-1L-MCV-M25	19340102256
2M25	HV10B-SF-1L-MCV-2M25	19340102296
PG16	HV10B-SF-1L-MCV-PG16	09340102256
2PG16	HV10B-SF-1L-MCV-2PG16	09340102296

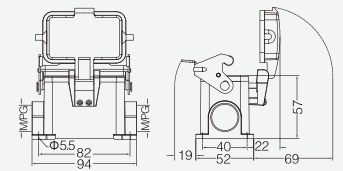

封底下壳 高结构 Housings, surface mounting, high construction



螺纹 Thread	型号 Type	订货号 Part Number
M25	HV10B-SFH-1L-M25	19340100291
2M25	HV10B-SFH-1L-2M25	19340100391
M32	HV10B-SFH-1L-M32	19340100292
2M32	HV10B-SFH-1L-2M32	19340100392
PG21	HV10B-SFH-1L-PG21	09340100192
2PG21	HV10B-SFH-1L-2PG21	09340100292
PG29	HV10B-SFH-1L-PG29	09340100193
2PG29	HV10B-SFH-1L-2PG29	09340100293
	带塑料盖 With plastic cover	
M25	HV10B-SFH-1L-CV-M25	19340100196
2M25	HV10B-SFH-1L-CV-2M25	19340100296
M32	HV10B-SFH-1L-CV-M32	19340100197
2M32	HV10B-SFH-1L-CV-2M32	19340100297
PG21	HV10B-SFH-1L-CV-PG21	09340100197
2PG21	HV10B-SFH-1L-CV-2PG21	09340100297
PG29	HV10B-SFH-1L-CV-PG29	09340100198
2PG29	HV10B-SFH-1L-CV-2PG29	09340100298
	带金属盖 With metal cover	
M25	HV10B-SFH-1L-MCV-M25	19340107295
2M25	HV10B-SFH-1L-MCV-2M25	19340107296
M32	HV10B-SFH-1L-MCV-M32	19340107297
2M32	HV10B-SFH-1L-MCV-2M32	19340107298
PG21	HV10B-SFH-1L-MCV-PG21	09340102197
2PG21	HV10B-SFH-1L-MCV-2PG21	09340102297
PG29	HV10B-SFH-1L-MCV-PG29	09340102198
2PG29	HV10B-SFH-1L-MCV-2PG29	09340102298

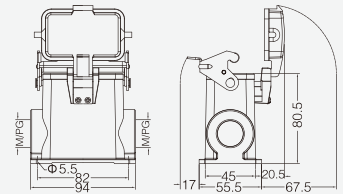



**Global District Limited**

**HV10B 金属外壳 用于高电压插芯 (HVE系列) Metal Hoods & Housings- For High Voltage Inserts(HVE Series)**

**防护等级 Degree of protection : IP65**

上壳 侧出线 Hoods, side entry



螺纹 Thread	型号 Type	订货号 Part Number
M20	HV10B-SE-4B-M20	19340100520
PG16	HV10B-SE-4B-PG16	09340100521

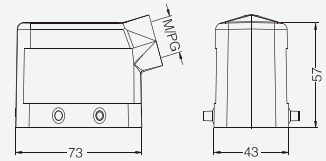

上壳 侧出线 高结构 Hoods, side entry, high construction



螺纹 Thread	型号 Type	订货号 Part Number
M25	HV10B-SEH-4B-M25	19340100551
M32	HV10B-SEH-4B-M32	19340100552
PG21	HV10B-SEH-4B-PG21	09340100552
PG29	HV10B-SEH-4B-PG29	09340100553

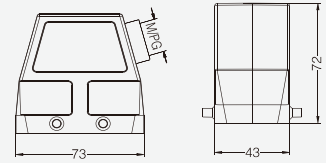

上壳 顶出线 Hoods, top entry



螺纹 Thread	型号 Type	订货号 Part Number
M20	HV10B-TE-4B-M20	19340100420
M25	HV10B-TE-4B-M25	19340100421
PG16	HV10B-TE-4B-PG16	09340100421

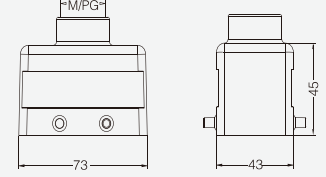

上壳 顶出线 高结构 Hoods, top entry, high construction



螺纹 Thread	型号 Type	订货号 Part Number
M25	HV10B-TEH-4B-M25	19340100451
M32	HV10B-TEH-4B-M32	19340100452
PG21	HV10B-TEH-4B-PG21	09340100452
PG29	HV10B-TEH-4B-PG29	09340100453

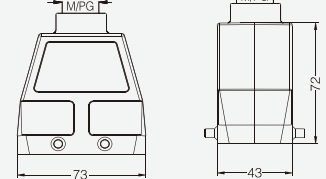

不封底下壳 Housings, bulkhead mounting



螺纹 Thread	型号 Type	订货号 Part Number
---	HV10B-BK-2L	09340100301

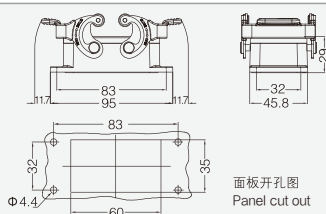

封底下壳 Housings, surface mounting



螺纹 Thread	型号 Type	订货号 Part Number
M20	HV10B-SF-2L-M20	19340100270
2M20	HV10B-SF-2L-2M20	19340100275
M25	HV10B-SF-2L-M25	19340100271
2M25	HV10B-SF-2L-2M25	19340100276
PG16	HV10B-SF-2L-PG16	09340100271
2PG16	HV10B-SF-2L-2PG16	09340100276

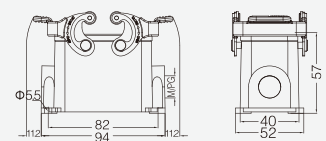





**Global District Limited**

**HV10B 金属外壳 用于高压插芯 ( HVE系列 ) Metal Hoods & Housings- For High Voltage Inserts(HVE Series)**

**防护等级 Degree of protection : IP65**

封底下壳 高结构 Housings, surface mounting, high construction



螺纹 Thread	型号 Type	订货号 Part Number
M25	HV10B-SFH-2L-M25	19340100231
2M25	HV10B-SFH-2L-2M25	19340100276
M32	HV10B-SFH-2L-M32	19340100232
2M32	HV10B-SFH-2L-2M32	19340100272
PG21	HV10B-SFH-2L-PG21	09340100232
2PG21	HV10B-SFH-2L-2PG21	09340100272
PG29	HV10B-SFH-2L-PG29	09340100233
2PG29	HV10B-SFH-2L-2PG29	09340100273

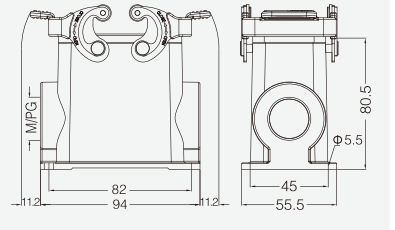

飞线下壳 Housings, cable to cable



螺纹 Thread	型号 Type	订货号 Part Number
M20	HV10B-CCT-2L-M20	19340100730
M25	HV10B-CCT-2L-M25	19340100731
PG16	HV10B-CCT-2L-PG16	09340101731

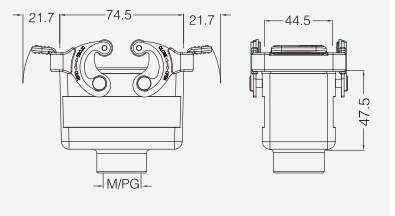

飞线下壳 高结构 Housings, cable to cable, high construction



螺纹 Thread	型号 Type	订货号 Part Number
M25	HV10B-CCTH-2L-M25	19340100736
M32	HV10B-CCTH-2L-M32	19340100737
PG21	HV10B-CCTH-2L-PG21	09340100732
PG29	HV10B-CCTH-2L-PG29	09340100733

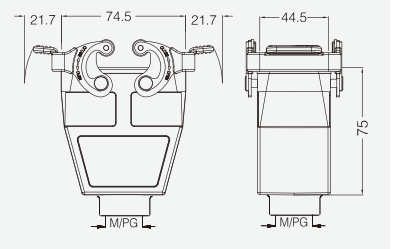

塑料防护盖 4卡扣 Protection covers, plastic



接线方式 Connect way	描述 Applications	型号 Type	订货号 Part Number
---	用于上壳 For hoods	H10B-CV-4C	09340105401

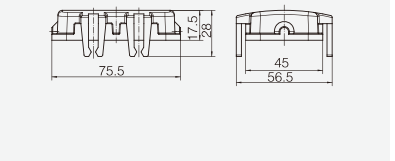

塑料防护盖 Protection covers, plastic



接线方式 Connect way	描述 Applications	型号 Type	订货号 Part Number
	塑料盖/用于飞线下壳 For Housings, cable to cable	H10B-CV-4B/1	09300105426
	塑料盖/用于不封底,封底下壳 For housing, bulkhead/ surface mounting	H10B-CV-4B/2	09300105428

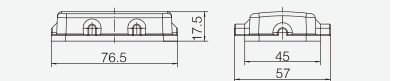



**Global District Limited**

**HV10B 金属外壳 用于高电压插芯 ( HVE系列 ) Metal Hoods & Housings- For High Voltage Inserts(HVE Series)**

**防护等级 Degree of protection : IP65**

上壳 侧出线 Hoods, side entry



螺纹 Thread	型号 Type	订货号 Part Number
M20	HV10B-SE-2L-M20	19340101530
PG16	HV10B-SE-2L-PG16	09340101531

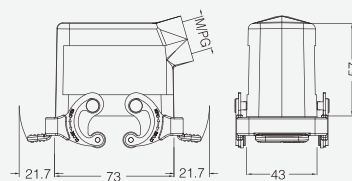

上壳 侧出线 高结构 Hoods, side entry, high construction



螺纹 Thread	型号 Type	订货号 Part Number
M25	HV10B-SEH-2L-M25	19340100536
M32	HV10B-SEH-2L-M32	19340100537
PG21	HV10B-SEH-2L-PG21	09340100532
PG29	HV10B-SEH-2L-PG29	09340100533

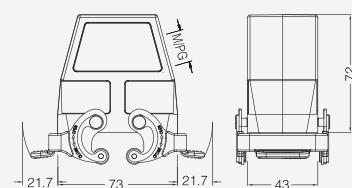

上壳 顶出线 Hoods, top entry



螺纹 Thread	型号 Type	订货号 Part Number
M20	HV10B-TE-2L-M20	19340101430
PG16	HV10B-TE-2L-PG16	09340101431

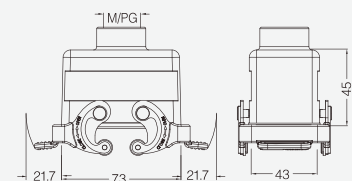

上壳 顶出线 高结构 Hoods, top entry, high construction



螺纹 Thread	型号 Type	订货号 Part Number
M25	HV10B-TEH-2L-M25	19340100436
M32	HV10B-TEH-2L-M32	19340100437
PG21	HV10B-TEH-2L-PG21	09340100432
PG29	HV10B-TEH-2L-PG29	09340100433

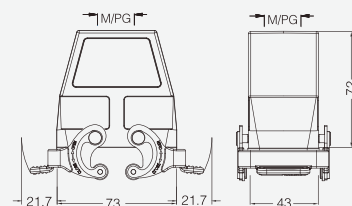

不封底下壳 Housings, bulkhead mounting



螺纹 Thread	型号 Type	订货号 Part Number
---	HV10B-BK-4B	09300100300
---	带塑料盖 With plastic cover	
---	HV10B-BK-4B-CV	09340100302
---	带金属盖 With metal cover	
---	HV10B-BK-4B-MCV	09340100317

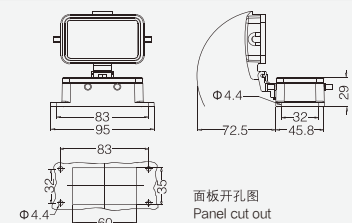



Global District Limited

HV10B 金属外壳 用于高电压插芯 (HVE系列) Metal Hoods & Housings- For High Voltage Inserts(HVE Series)

防护等级 Degree of protection : IP65

封底下壳 Housings, surface mounting



螺纹 Thread	型号 Type	订货号 Part Number
M20	HV10B-SF-4B-M20	19340101125
2M20	HV10B-SF-4B-2M20	19340101165
M25	HV10B-SF-4B-M25	19340101126
2M25	HV10B-SF-4B-2M25	19340101166
PG16	HV10B-SF-4B-PG16	09340101121
2PG16	HV10B-SF-4B-2PG16	09340101161
带塑料盖 With plastic cover		
M20	HV10B-SF-4B-CV-M20	19340101225
2M20	HV10B-SF-4B-CV-2M20	19340101265
M25	HV10B-SF-4B-CV-M25	19340101226
2M25	HV10B-SF-4B-CV-2M25	19340101266
PG16	HV10B-SF-4B-CV-PG16	09340101221
2PG16	HV10B-SF-4B-CV-2PG16	09340101261
带金属盖 With metal cover		
M20	HV10B-SF-4B-MCV-M20	19340102225
2M20	HV10B-SF-4B-MCV-2M20	19340102265
M25	HV10B-SF-4B-MCV-M25	19340102226
2M25	HV10B-SF-4B-MCV-2M25	19340102266
PG16	HV10B-SF-4B-MCV-PG16	09340102221
2PG16	HV10B-SF-4B-MCV-2PG16	09340102261

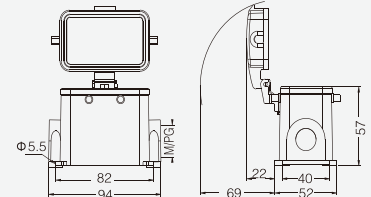

封底下壳 高结构 Housings, surface mounting, high construction



螺纹 Thread	型号 Type	订货号 Part Number
M25	HV10B-SFH-4B-M25	19340100126
2M25	HV10B-SFH-4B-2M25	19340100166
M32	HV10B-SFH-4B-M32	19340100127
2M32	HV10B-SFH-4B-2M32	19340100167
PG21	HV10B-SFH-4B-PG21	09340100122
2PG21	HV10B-SFH-4B-2PG21	09340100162
PG29	HV10B-SFH-4B-PG29	09340100123
2PG29	HV10B-SFH-4B-2PG29	09340100163
带塑料盖 With plastic cover		
M25	HV10B-SFH-4B-CV-M25	19340100226
2M25	HV10B-SFH-4B-CV-2M25	19340100266
M32	HV10B-SFH-4B-CV-M32	19340100227
2M32	HV10B-SFH-4B-CV-2M32	19340100267
PG21	HV10B-SFH-4B-CV-PG21	09340100222
2PG21	HV10B-SFH-4B-CV-2PG21	09340100262
PG29	HV10B-SFH-4B-CV-PG29	09340100223
2PG29	HV10B-SFH-4B-CV-2PG29	09340100263
带金属盖 With metal cover		
M25	HV10B-SFH-4B-MCV-M25	19340102226
2M25	HV10B-SFH-4B-MCV-2M25	19340102266
M32	HV10B-SFH-4B-MCV-M32	19340102227
2M32	HV10B-SFH-4B-MCV-2M32	19340102267
PG21	HV10B-SFH-4B-MCV-PG21	09340102222
2PG21	HV10B-SFH-4B-MCV-2PG21	09340102262
PG29	HV10B-SFH-4B-MCV-PG29	09340102223
2PG29	HV10B-SFH-4B-MCV-2PG29	09340102263

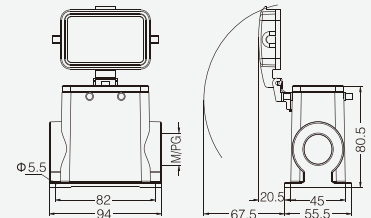

防护盖 Protection covers, metal



接线方式 Connect way	描述 Applications	型号 Type	订货号 Part Number
	金属盖/用于上壳 For hoods	H10B-MCV-4B/1	09340105457
	金属盖/用于下壳 For housings	H10B-MCV-4B/2	09340105458

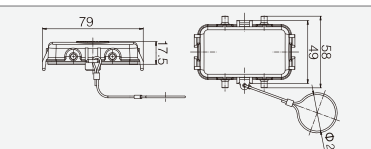

防护盖 Protection covers, metal



接线方式 Connect way	描述 Applications	型号 Type	订货号 Part Number
	金属盖/用于上壳 For hoods	H10B-MCV-2L.1S	09340105423
	金属盖/用于下壳 For housings	H10B-MCV-2L.2S	09340105424

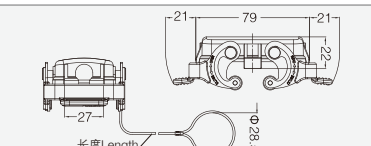



16B 塑料外壳 Plastic Hoods & Housings

防护等级 Degree of protection : IP65

上壳 侧出线 高结构 Hoods, side entry, high construction



螺纹 Thread	型号 Type	订货号 Part Number
M32	H16B.P-SEH-4B-M32	19300160111
M40	H16B.P-SEH-4B-M40	19300160112

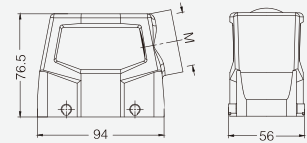

上壳 顶出线 高结构 Hoods, top entry, high construction



螺纹 Thread	型号 Type	订货号 Part Number
M32	H16B.P-TEH-4B-M32	19300160121
M40	H16B.P-TEH-4B-M40	19300160122

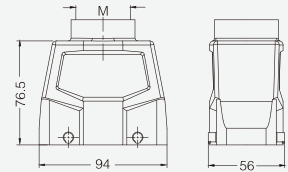

不封底下壳 Housings, bulkhead mounting



螺纹 Thread	型号 Type	订货号 Part Number
---	H16B.P-BK-2L	09300160300

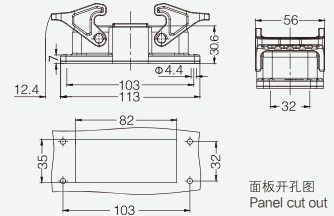

封底下壳 高结构 Housings, surface mounting, high construction



螺纹 Thread	型号 Type	订货号 Part Number
M32	H16B.P-SFH-2L-M32	19300160132
2M32	H16B.P-SFH-2L-2M32	19300160136
M40	H16B.P-SFH-2L-M40	19300160133
2M40	H16B.P-SFH-2L-2M40	19300160137

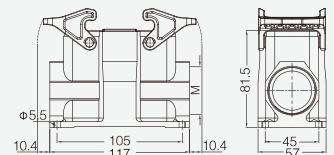

防护盖 Protection covers, metal



螺纹 Thread	型号 Type	订货号 Part Number
---	H16B.P-CV-4B/2	09300160140

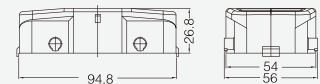

防护盖 Protection covers, metal



螺纹 Thread	型号 Type	订货号 Part Number
---	H16B.P-CV-2L/1	09300160145

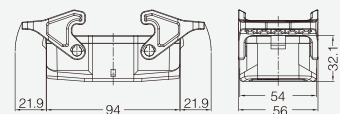



16B金属外壳 Metal Hoods & Housings

防护等级 Degree of protection : IP65

上壳 侧出线 Hoods, side entry



螺纹 Thread	型号 Type	订货号 Part Number
M25	H16B-SE-2B-M25	19300161541
M32	H16B-SE-2B-M32	19300161542
PG21	H16B-SE-2B-PG21	09300161540

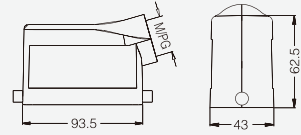

上壳 侧出线 高结构 Hoods, side entry, high construction



螺纹 Thread	型号 Type	订货号 Part Number
M32	H16B-SEH-2B-M32	19300160547
M40	H16B-SEH-2B-M40	19300160548
PG21	H16B-SEH-2B-PG21	09300160540
PG29	H16B-SEH-2B-PG29	09300160541

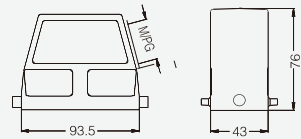

上壳 顶出线 Hoods, top entry



螺纹 Thread	型号 Type	订货号 Part Number
M25	H16B-TE-2B-M25	19300161441
M32	H16B-TE-2B-M32	19300161442
PG21	H16B-TE-2B-PG21	09300161440

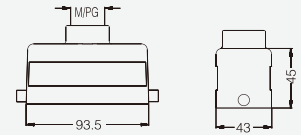

上壳 顶出线 高结构 Hoods, top entry, high construction



螺纹 Thread	型号 Type	订货号 Part Number
M32	H16B-TEH-2B-M32	19300160447
M40	H16B-TEH-2B-M40	19300160448
PG21	H16B-TEH-2B-PG21	09300160440
PG29	H16B-TEH-2B-PG29	09300160441

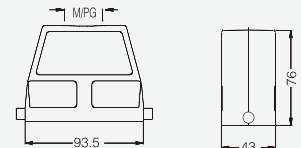

飞线下壳 Housings, cable to cable



螺纹 Thread	型号 Type	订货号 Part Number
M25	H16B-CCT-1L-M25	19300161751
M32	H16B-CCT-1L-M32	19300161752
PG21	H16B-CCT-1L-PG21	09300161750

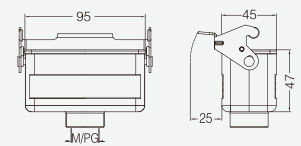

飞线下壳 高结构 Housings, cable to cable, high construction



螺纹 Thread	型号 Type	订货号 Part Number
M32	H16B-CCTH-1L-M32	19300160757
M40	H16B-CCTH-1L-M40	19300160758
PG21	H16B-CCTH-1L-PG21	09300160750
PG29	H16B-CCTH-1L-PG29	09300160751

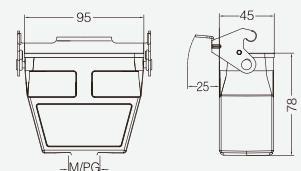



16B 金属外壳 Metal Hoods & Housings

防护等级 Degree of protection : IP65

不封底下壳 Housings, bulkhead mounting

螺纹 Thread	型号 Type	订货号 Part Number
---	H16B-BK-1L	09300160307
	带塑料盖 With plastic cover	
---	H16B-BK-1L-CV	09300160306
	带金属盖 With metal cover	
---	H16B-BK-1L-MCV	09300160318



面板开孔图  
Panel cut out

封底下壳 Housings, surface mounting

螺纹 Thread	型号 Type	订货号 Part Number
M25	H16B-SF-1L-M25	19300161251
2M25	H16B-SF-1L-2M25	19300161291
PG21	H16B-SF-1L-PG21	09300161250
2PG21	H16B-SF-1L-2PG21	09300161290
	带塑料盖 With plastic cover	
M25	H16B-SF-1L-CV-M25	19300161256
2M25	H16B-SF-1L-CV-2M25	19300161296
PG21	H16B-SF-1L-CV-PG21	09300161255
2PG21	H16B-SF-1L-CV-2PG21	09300161295
	带金属盖 With metal cover	
M25	H16B-SF-1L-MCV-M25	19300162256
2M25	H16B-SF-1L-MCV-2M25	19300162296
PG21	H16B-SF-1L-MCV-PG21	09300162255
2PG21	H16B-SF-1L-MCV-2PG21	09300162295

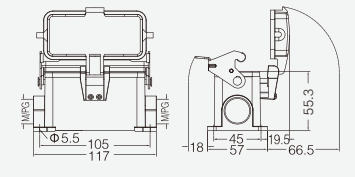
封底下壳 高结构 Housings, surface mounting, high construction

螺纹 Thread	型号 Type	订货号 Part Number
M32	H16B-SFH-1L-M32	19300160252
2M25	H16B-SFH-1L-2M25	19300160291
2M32	H16B-SFH-1L-2M32	19300160292
PG21	H16B-SFH-1L-PG21	09300160250
2PG21	H16B-SFH-1L-2PG21	09300160290
PG29	H16B-SFH-1L-PG29	09300160251
2PG29	H16B-SFH-1L-2PG29	09300160291
	带塑料盖 With plastic cover	
M32	H16B-SFH-1L-CV-M32	19300160257
2M32	H16B-SFH-1L-CV-2M32	19300160297
PG21	H16B-SFH-1L-CV-PG21	09300160255
2PG21	H16B-SFH-1L-CV-2PG21	09300160295
PG29	H16B-SFH-1L-CV-PG29	09300160256
2PG29	H16B-SFH-1L-CV-2PG29	09300160296
	带金属盖 With metal cover	
M32	H16B-SFH-1L-MCV-M32	19300167257
2M32	H16B-SFH-1L-MCV-2M32	19300167297
PG21	H16B-SFH-1L-MCV-PG21	09300162257
2PG21	H16B-SFH-1L-MCV-2PG21	09300162297
PG29	H16B-SFH-1L-MCV-PG29	09300162258
2PG29	H16B-SFH-1L-MCV-2PG29	09300162298

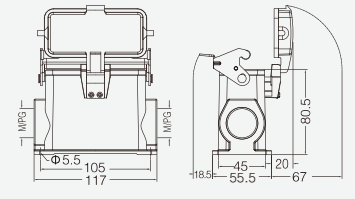

16B金属外壳 Metal Hoods & Housings

防护等级 Degree of protection : IP65

上壳 侧出线 Hoods, side entry



螺纹 Thread	型号 Type	订货号 Part Number
M25	H16B-SE-4B-M25	19300161521
M32	H16B-SE-4B-M32	19300161522
PG21	H16B-SE-4B-PG21	09300161520

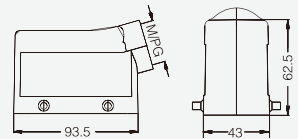

上壳 侧出线 高结构 Hoods, side entry, high construction



螺纹 Thread	型号 Type	订货号 Part Number
M25	H16B-SEH-4B-M25	19300160526
M32	H16B-SEH-4B-M32	19300160527
M40	H16B-SEH-4B-M40	19300160528
PG21	H16B-SEH-4B-PG21	09300160520
PG29	H16B-SEH-4B-PG29	09300160521

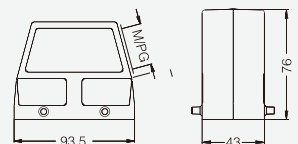

我司可提供顶部、侧面同时出线的非标品, 详见P17-08  
We can provide non-standard products with both top&side entry, see P17-08

上壳 顶出线 Hoods, top entry



螺纹 Thread	型号 Type	订货号 Part Number
M25	H16B-TE-4B-M25	19300161421
M32	H16B-TE-4B-M32	19300161422
PG21	H16B-TE-4B-PG21	09300161420

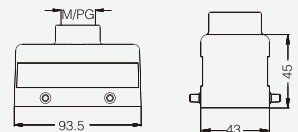

上壳 顶出线 高结构 Hoods, top entry, high construction



螺纹 Thread	型号 Type	订货号 Part Number
M32	H16B-TEH-4B-M32	19300160427
M40	H16B-TEH-4B-M40	19300160428
PG21	H16B-TEH-4B-PG21	09300160420
PG29	H16B-TEH-4B-PG29	09300160421
2M25	H16B-TEH-4B-2M25	19300160466
2PG16	H16B-TEH-4B-2PG16	09300160461
2PG21	H16B-TEH-4B-2PG21	09300160462

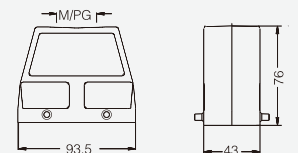

不封底下壳 Housings, bulkhead mounting



螺纹 Thread	型号 Type	订货号 Part Number
---	H16B-BK-2L	09300160301

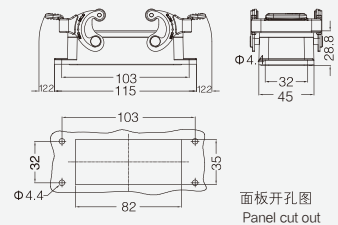

封底下壳 Housings, surface mounting



螺纹 Thread	型号 Type	订货号 Part Number
M25	H16B-SF-2L-M25	19300161231
2M25	H16B-SF-2L-2M25	19300161271
PG21	H16B-SF-2L-PG21	09300161230
2PG21	H16B-SF-2L-2PG21	09300161270

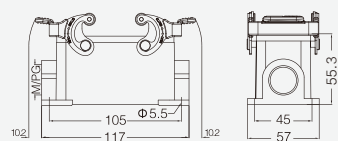



16B 金属外壳 Metal Hoods & Housings

防护等级 Degree of protection : IP65

封底下壳 高结构 Housings, surface mounting, high construction



螺纹 Thread	型号 Type	订货号 Part Number
2M25	H16B-SFH-2L-2M25	19300160271
M32	H16B-SFH-2L-M32	19300160232
2M32	H16B-SFH-2L-2M32	19300160272
2M40	H16B-SFH-2L-2M40	19300160273
PG21	H16B-SFH-2L-PG21	09300160230
2PG21	H16B-SFH-2L-2PG21	09300160270
PG29	H16B-SFH-2L-PG29	09300160231
2PG29	H16B-SFH-2L-2PG29	09300160271

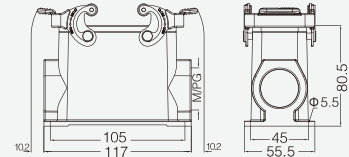

飞线下壳 Housings, cable to cable



螺纹 Thread	型号 Type	订货号 Part Number
M25	H16B-CCT-2L-M25	19300161731
M32	H16B-CCT-2L-M32	19300161732
PG21	H16B-CCT-2L-PG21	09300161730

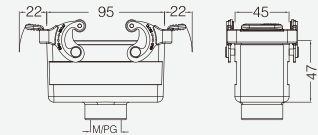

飞线下壳 高结构 Housings, cable to cable, high construction



螺纹 Thread	型号 Type	订货号 Part Number
M25	H16B-CCTH-2L-M25	19300160736
M32	H16B-CCTH-2L-M32	19300160737
M40	H16B-CCTH-2L-M40	19300160738
PG21	H16B-CCTH-2L-PG21	09300160730
PG29	H16B-CCTH-2L-PG29	09300160731

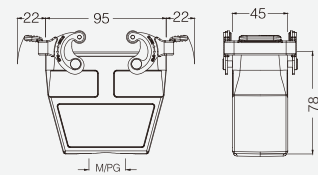

塑料防护盖 4卡扣 Protection covers, plastic



接线方式 Connect way	描述 Applications	型号 Type	订货号 Part Number
---	用于上壳	H16B-CV-4C	09300165401

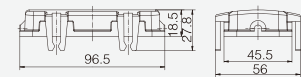

塑料防护盖 Protection covers, plastic



接线方式 Connect way	描述 Applications	型号 Type	订货号 Part Number
	塑料盖/用于飞线下壳 For Housings, cable to cable	H16B-CV-4B/1	09300165427
	塑料盖/用于不封底,封底下壳 For housing, bulkhead/ surface mounting	H16B-CV-4B/2	09300165428

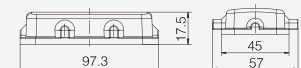





16B金属外壳 Metal Hoods & Housings

防护等级 Degree of protection : IP65

上壳 侧出线 Hoods, side entry



螺纹 Thread	型号 Type	订货号 Part Number
M25	H16B-SE-2L-M25	19300161531
M32	H16B-SE-2L-M32	19300161532
PG21	H16B-SE-2L-PG21	09300161530

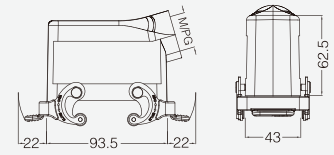

上壳 侧出线 高结构 Hoods, side entry, high construction



螺纹 Thread	型号 Type	订货号 Part Number
M25	H16B-SEH-2L-M25	19300160536
M32	H16B-SEH-2L-M32	19300160537
M40	H16B-SEH-2L-M40	19300160538
PG21	H16B-SEH-2L-PG21	09300160530
PG29	H16B-SEH-2L-PG29	09300160531

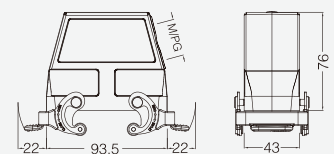

上壳 顶出线 Hoods, top entry



螺纹 Thread	型号 Type	订货号 Part Number
M25	H16B-TE-2L-M25	19300161431
M32	H16B-TE-2L-M32	19300161432
PG21	H16B-TE-2L-PG21	09300161430

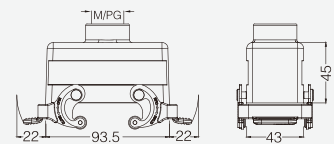

上壳 顶出线 高结构 Hoods, top entry, high construction



螺纹 Thread	型号 Type	订货号 Part Number
M32	H16B-TEH-2L-M32	19300160437
M40	H16B-TEH-2L-M40	19300160438
PG21	H16B-TEH-2L-PG21	09300160430
PG29	H16B-TEH-2L-PG29	09300160431

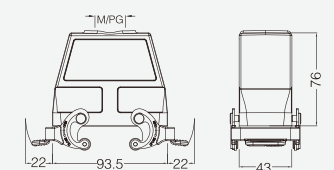

不封底下壳 Housings, bulkhead mounting



螺纹 Thread	型号 Type	订货号 Part Number
---	H16B-BK-4B	09300160300
---	带塑料盖 With plastic cove	
---	H16B-BK-4B-CV	09300160302
---	带金属盖 With metal cover	
---	H16B-BK-4B-MCV	09300160317

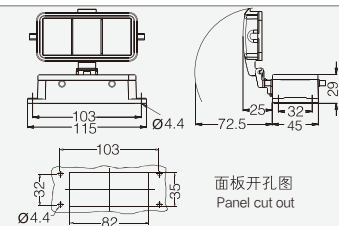



16B 金属外壳 Metal Hoods & Housings

防护等级 Degree of protection : IP65

封底下壳 Housings, surface mounting



螺纹 Thread	型号 Type	订货号 Part Number
M25	H16B-SF-4B-M25	19300161126
2M25	H16B-SF-4B-2M25	19300161166
PG21	H16B-SF-4B-PG21	09300161120
2PG21	H16B-SF-4B-2PG21	09300161160
	带塑料盖 With plastic cover	
M25	H16B-SF-4B-CV-M25	19300161226
2M25	H16B-SF-4B-CV-2M25	19300161266
PG21	H16B-SF-4B-CV-PG21	09300161220
2PG21	H16B-SF-4B-CV-2PG21	09300161260
	带金属盖 With metal cover	
M25	H16B-SF-4B-MCV-M25	19300162226
2M25	H16B-SF-4B-MCV-2M25	19300162266
PG21	H16B-SF-4B-MCV-PG21	09300162220
2PG21	H16B-SF-4B-MCV-2PG21	09300162260

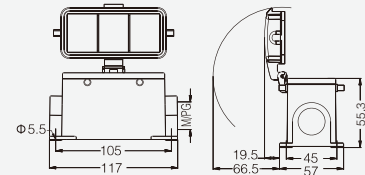

封底下壳 高结构 Housings, surface mounting, high construction



螺纹 Thread	型号 Type	订货号 Part Number
M25	H16B-SFH-4B-M32	19300160127
M32	H16B-SFH-4B-2M32	19300160167
M40	H16B-SFH-4B-PG21	09300160120
PG21	H16B-SFH-4B-2PG21	09300160160
PG29	H16B-SFH-4B-PG29	09300160121
2PG29	H16B-SFH-4B-2PG29	09300160161
	带塑料盖 With plastic cover	
M32	H16B-SFH-4B-CV-M32	19300160227
2M32	H16B-SFH-4B-CV-2M32	19300160267
PG21	H16B-SFH-4B-CV-PG21	09300160220
2PG21	H16B-SFH-4B-CV-2PG21	09300160260
PG29	H16B-SFH-4B-CV-PG29	09300160221
2PG29	H16B-SFH-4B-CV-2PG29	09300160261
	带金属盖 With metal cover	
M32	H16B-SFH-4B-MCV-M32	19300160327
2M32	H16B-SFH-4B-MCV-2M32	19300160367
PG21	H16B-SFH-4B-MCV-PG21	09300160320
2PG21	H16B-SFH-4B-MCV-2PG21	09300160360
PG29	H16B-SFH-4B-MCV-PG29	09300160321
2PG29	H16B-SFH-4B-MCV-2PG29	09300160361

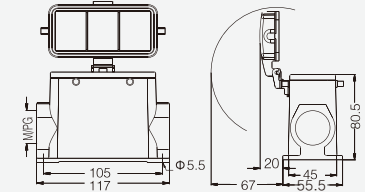

防护盖 Protection covers, metal



接线方式 Connect way	描述 Applications	型号 Type	订货号 Part Number
	金属盖/用于上壳 For hoods	H16B-MCV-4B/1	09300165426
	金属盖/用于下壳 For housings	H16B-MCV-4B/2	09300165425

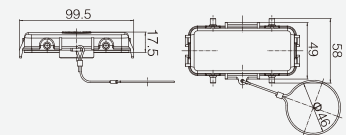

防护盖 Protection covers, metal



接线方式 Connect way	描述 Applications	型号 Type	订货号 Part Number
	金属盖/用于上壳 For hoods	H16B-MCV-2L.1S	09300165422
	金属盖/用于下壳 For housings	H16B-MCV-2L.2S	09300165423

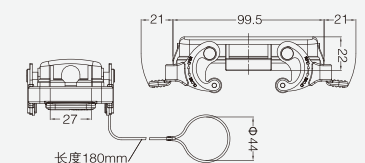



16B金属外壳 Metal Hoods & Housings

防护等级 Degree of protection : IP65

上壳 侧出线 高结构 Hoods, side entry, high construction



螺纹 Thread	型号 Type	订货号 Part Number
M25	H16B-SEH-1L/C-M25	19300160586
M32	H16B-SEH-1L/C-M32	19300160587
PG21	H16B-SEH-1L/C-PG21	09300160580
PG29	H16B-SEH-1L/C-PG29	09300160581

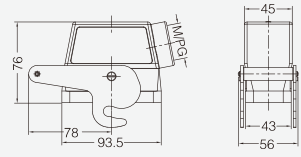

不封底下壳 Housings, bulkhead mounting



螺纹 Thread	型号 Type	订货号 Part Number
---	H16B-BK-2B/C	09300160381

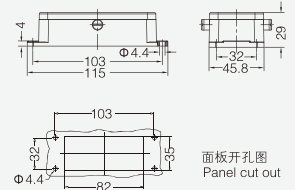

上壳侧出线/顶出线 高结构 Hoods,side&top entry,high construction



型号为:H16B-SEH/TEH-4B-XX/XX  
如有需要请与我司联系



**Global District Limited**

16B 金属外壳 适用于苛刻环境(耐腐蚀) Metal Hoods & Housings For higher environmental requirements

防护等级 Degree of protection : IP65

上壳 侧出线 Hoods, side entry



螺纹 Thread	型号 Type	订货号 Part Number
M25	H16B-MSE-4B-M25	19370161521
PG21	H16B-MSE-4B-PG21	09370161520

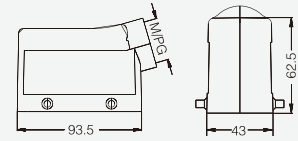

上壳 侧出线 高结构 Hoods, side entry, high construction



螺纹 Thread	型号 Type	订货号 Part Number
M32	H16B-MSEH-4B-M32	19370160527
M40	H16B-MSEH-4B-M40	19370160528
PG29	H16B-MSEH-4B-PG29	09370160521

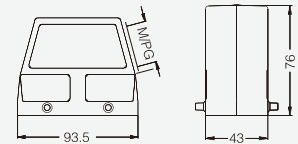

上壳 顶出线 Hoods, top entry



螺纹 Thread	型号 Type	订货号 Part Number
M25	H16B-MTE-4B-M25	19370161421
PG21	H16B-MTE-4B-PG21	09370161420

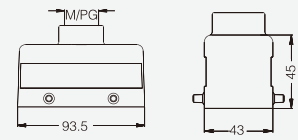

上壳 顶出线 高结构 Hoods, top entry, high construction



螺纹 Thread	型号 Type	订货号 Part Number
M32	H16B-MTEH-4B-M32	19370160427
PG29	H16B-MTEH-4B-PG29	09370160421

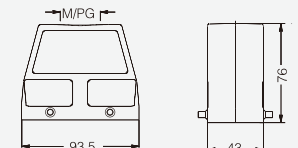

不封底下壳 Housings, bulkhead mounting



螺纹 Thread	型号 Type	订货号 Part Number
---	H16B-MBK-2L	09370160301

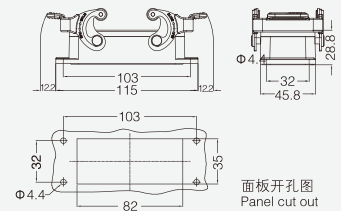

封底下壳 Housings, surface mounting



螺纹 Thread	型号 Type	订货号 Part Number
M25	H16B-MSF-2L-M25	19370161231
PG21	H16B-MSF-2L-PG21	09370161230

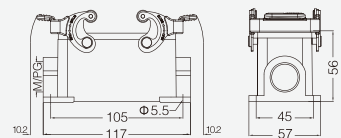



Global District Limited

16B 金属外壳 适用于苛刻环境(耐腐蚀) Metal Hoods & Housings For higher environmental requirements

防护等级 Degree of protection : IP65

封底下壳 高结构 Housings, surface mounting, high construction



螺纹 Thread	型号 Type	订货号 Part Number
2M32	H16B-MSFH-2L-2M32	19370160272
2M40	H16B-MSFH-2L-2M40	19370160273
2PG29	H16B-MSFH-2L-2PG29	09370160271

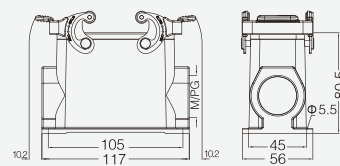

飞线下壳 Housings, cable to cable



螺纹 Thread	型号 Type	订货号 Part Number
PG21	H16B-MCCT-2L-PG21	09370161730

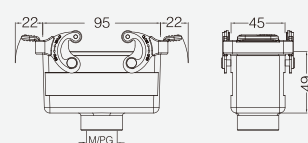

防护盖 Protection covers, metal



接线方式 Connect way	描述 Applications	型号 Type	订货号 Part Number
	金属盖/用于上壳 For hoods	H16B-MMCV-4B/1	09370165404
	金属盖/用于下壳 For housings	H16B-MMCV-4B/2	09370165405

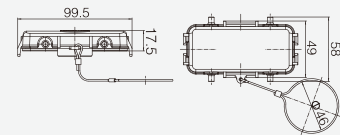

防护盖 Protection covers, metal



接线方式 Connect way	描述 Applications	型号 Type	订货号 Part Number
	金属盖/用于上壳 For hoods	H16B-MMCV-2L.1S	09370165402
	金属盖/用于下壳 For housings	H16B-MMCV-2L.2S	09370165403

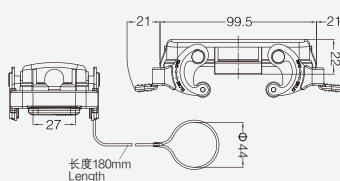

防护等级 Degree of protection : IP65

上壳 侧出线 高结构 Hoods, side entry, high construction



螺纹 Thread	型号 Type	订货号 Part Number
M32	H16B-MSEH-1L-M32	19370160587
PG21	H16B-MSEH-1L-PG21	09370160587
PG29	H16B-MSEH-1L-PG29	09370160588

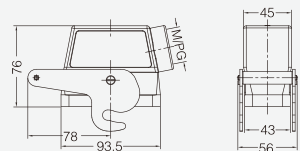

不封底下壳 Housings, bulkhead mounting



螺纹 Thread	型号 Type	订货号 Part Number
---	H16B-MBK-2B/C	09370160381

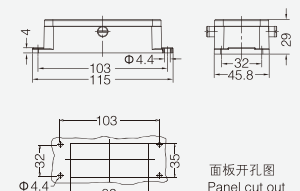



16B 高防护外壳 Hoods & Housings For Harsh Environmental Requirements

防护等级 Degree of protection : IP68

上壳 侧出线 高结构 Hoods, side entry, high construction



螺纹 Thread	型号 Type	订货号 Part Number
M25	HP16B-SEH-2S-M25	19400160211
M32	HP16B-SEH-2S-M32	19400160212
M40	HP16B-SEH-2S-M40	19400160213
PG21	HP16B-SEH-2S-PG21	09400160212
PG29	HP16B-SEH-2S-PG29	09400160213

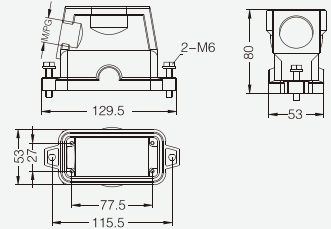

上壳 顶出线 高结构 Hoods, top entry, high construction



螺纹 Thread	型号 Type	订货号 Part Number
M25	HP16B-TEH-2S-M25	19400160221
M32	HP16B-TEH-2S-M32	19400160222
M40	HP16B-TEH-2S-M40	19400160223
M50	HP16B-TEH-2S-M50	19400160224
PG21	HP16B-TEH-2S-PG21	09400160222
PG29	HP16B-TEH-2S-PG29	09400160223

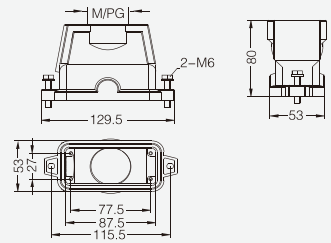

封底下壳 Housings, surface mounting



螺纹 Thread	型号 Type	订货号 Part Number
M25	HP16B-SFH-2H-M25	19400160231
M32	HP16B-SFH-2H-M32	19400160232
M40	HP16B-SFH-2H-M40	19400160233
PG21	HP16B-SFH-2H-PG21	09400160232
PG29	HP16B-SFH-2H-PG29	09400160233

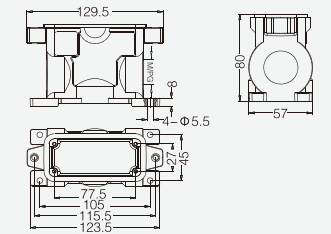

不封底下壳 Housings, bulkhead mounting



螺纹 Thread	型号 Type	订货号 Part Number
---	HP16B-BK-2H	09400160201

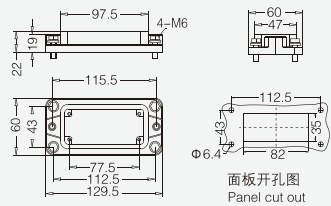



**16B 高防护外壳 Hoods & Housings For Harsh Environmental Requirements**

**防护等级 Degree of protection : IP68**

上壳 侧出线 高结构 Hoods, side entry, high construction



螺纹 Thread	型号 Type	订货号 Part Number
	螺栓联锁 Screw locking	
M25	HP16B/H-SEH-2S-M25	19400160511
M32	HP16B/H-SEH-2S-M32	19400160512
M40	HP16B/H-SEH-2S-M40	19400160513
M50	HP16B/H-SEH-2S-M50	19400160514
PG21	HP16B/H-SEH-2S-PG21	09400160512
PG29	HP16B/H-SEH-2S-PG29	09400160513
PG36	HP16B/H-SEH-2S-PG36	09400160514
	轴销联锁 Toggle locking	
M25	HP16B/H-SEH-2T-M25	19400160501
M32	HP16B/H-SEH-2T-M32	19400160502
M40	HP16B/H-SEH-2T-M40	19400160503
PG21	HP16B/H-SEH-2T-PG21	09400160502
PG29	HP16B/H-SEH-2T-PG29	09400160503
PG36	HP16B/H-SEH-2T-PG36	09400160504

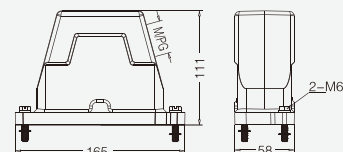

上壳 顶出线 高结构 Hoods, top entry, high construction



螺纹 Thread	型号 Type	订货号 Part Number
	螺栓联锁 Screw locking	
M25	HP16B/H-TEH-2S-M25	19400160411
M32	HP16B/H-TEH-2S-M32	19400160412
M40	HP16B/H-TEH-2S-M40	19400160413
M50	HP16B/H-TEH-2S-M50	19400160414
PG21	HP16B/H-TEH-2S-PG21	09400160412
PG29	HP16B/H-TEH-2S-PG29	09400160413
PG36	HP16B/H-TEH-2S-PG36	09400160414
	轴销联锁 Toggle locking	
M25	HP16B/H-TEH-2T-M25	19400160401
M32	HP16B/H-TEH-2T-M32	19400160402
M40	HP16B/H-TEH-2T-M40	19400160403
M50	HP16B/H-TEH-2T-M50	19400160404
PG21	HP16B/H-TEH-2T-PG21	09400160402
PG29	HP16B/H-TEH-2T-PG29	09400160403
PG36	HP16B/H-TEH-2T-PG36	09400160404

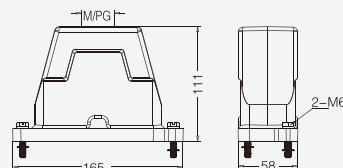

封底下壳 高结构 Housings, surface mounting, high construction



螺纹 Thread	型号 Type	订货号 Part Number
	螺栓联锁 Screw locking	
M25	HP16B/H-SFH-2H-M25	19400161261
M32	HP16B/H-SFH-2H-M32	19400161262
M40	HP16B/H-SFH-2H-M40	19400161263
PG21	HP16B/H-SFH-2H-PG21	09400161261
PG29	HP16B/H-SFH-2H-PG29	09400161262
PG36	HP16B/H-SFH-2H-PG36	09400161263
	轴销联锁 Toggle locking	
M25	HP16B/H-SFH-2T-M25	19400161281
M32	HP16B/H-SFH-2T-M32	19400161282
M40	HP16B/H-SFH-2T-M40	19400161283
PG21	HP16B/H-SFH-2T-PG21	09400161282
PG29	HP16B/H-SFH-2T-PG29	09400161283

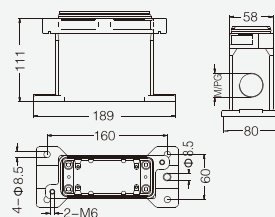



16B 高防护外壳 Hoods & Housings For Harsh Environmental Requirements

防护等级 Degree of protection : IP68

不封底下壳 Housings, bulkhead mounting



螺纹 Thread	型号 Type	订货号 Part Number
---	螺栓联锁 Screw locking	
---	HP16B/H-BK-2H	09400160311
---	轴销联锁 Toggle locking	
---	HP16B/H-BK-2T	09400160301
	带金属盖 With metal cover	
---	螺栓联锁 Screw locking	
---	HP16B/H-BK-2H-MCV	09400160317
---	轴销联锁 Toggle locking	
---	HP16B/H-BK-2T-MCV	09400160307

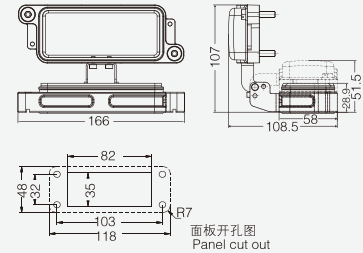

防护盖 Protection covers, metal



螺纹 Thread	型号 Type	订货号 Part Number
---	螺栓联锁 Screw locking	
---	HP16B/H-MCV-2S	09400165411
---	轴销联锁 Toggle locking	
---	HP16B/H-MCV-2T	09400165401

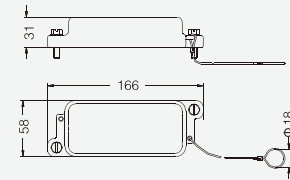

上壳 侧出线 高结构 Hoods, side entry, high construction



螺纹 Thread	型号 Type	订货号 Part Number
M25	HP16B/H-SEH-4S-M25	19400161361
M32	HP16B/H-SEH-4S-M32	19400161362
M40	HP16B/H-SEH-4S-M40	19400161363
PG21	HP16B/H-SEH-4S-PG21	09400161362
PG29	HP16B/H-SEH-4S-PG29	09400161363

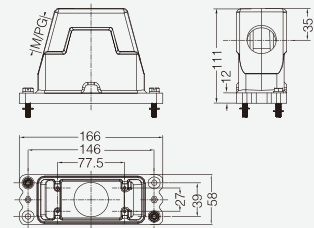

上壳 顶出线 高结构 Hoods, top entry, high construction



螺纹 Thread	型号 Type	订货号 Part Number
M25	HP16B/H-TEH-4S-M25	19400161461
M32	HP16B/H-TEH-4S-M32	19400161462
M40	HP16B/H-TEH-4S-M40	19400161463
M50	HP16B/H-TEH-4S-M50	19400161464
PG21	HP16B/H-TEH-4S-PG21	09400161461
PG29	HP16B/H-TEH-4S-PG29	09400161462
PG36	HP16B/H-TEH-4S-PG36	09400161463

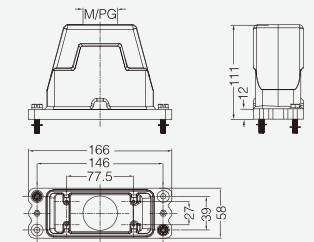

不封底下壳 Housings, bulkhead mounting



螺纹 Thread	型号 Type	订货号 Part Number
---	HP16B/H-BK-4H	09400160202

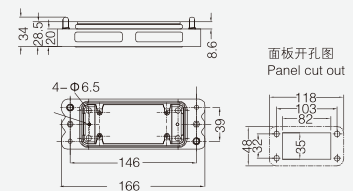





# Global District Limited

## 16B 高防护外壳 Hoods & Housings For Harsh Environmental Requirements

### 防护等级 Degree of protection : IP68

上壳 顶出线 高结构 Hoods, top entry, high construction EMC version



螺纹 Thread	型号 Type	订货号 Part Number
M32	EMC · H16B-TEH-4S-M32	19620160442
M40	EMC · H16B-TEH-4S-M40	19620160443
PG21	EMC · H16B-TEH-4S-PG21	09620160540
PG29	EMC · H16B-TEH-4S-PG29	09620160541

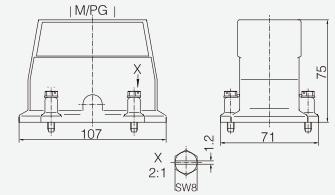

不封底下壳 Housings, bulkhead mounting EMC version



螺纹 Thread	型号 Type	订货号 Part Number
---	EMC · H16B-BK-4H	09620160301

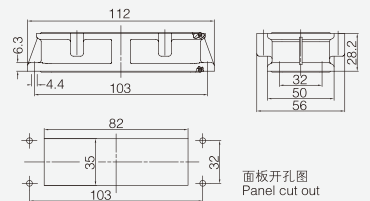

整体型外壳 侧出线 高结构 Hoods, side entry, high construction



螺纹 Thread	型号 Type	订货号 Part Number
M25	HC16B-SEH-2S-M32	19400161501
M32	HC16B-SEH-2S-M40	19400161502
PG21	HC16B-SEH-2S-PG21	09400161501
PG29	HC16B-SEH-2S-PG29	09400161502

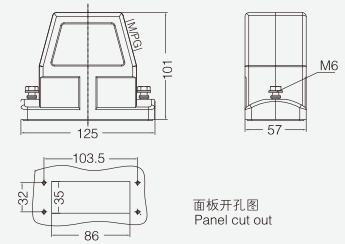

整体型外壳 顶出线 高结构 Hoods, top entry, high construction



螺纹 Thread	型号 Type	订货号 Part Number
M32	HC16B-TEH-2S-M32	19400161551
M40	HC16B-TEH-2S-M40	19400161552
PG21	HC16B-TEH-2S-PG21	09400161551
PG29	HC16B-TEH-2S-PG29	09400161552

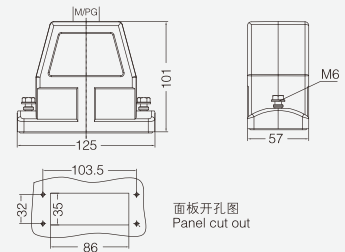

芯体安装支块 Mounting frames



螺纹 Thread	型号 Type	订货号 Part Number
---	APT-C	09400161600

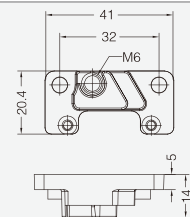



**Global District Limited**

**HV16B 金属外壳 适用高压插芯(HVE系列) Metal Hoods & Housings For HighVoltage Inserts(HVE Series)**

**防护等级 Degree of protection : IP65**

上壳 侧出线 Hoods, side entry

螺纹 Thread	型号 Type	订货号 Part Number
M25	HV16B-SE-2B-M25	19340161541
M32	HV16B-SE-2B-M32	19340161542
PG21	HV16B-SE-2B-PG21	09340161540

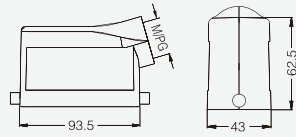
上壳 侧出线 高结构 Hoods, side entry, high construction

螺纹 Thread	型号 Type	订货号 Part Number
M32	HV16B-SEH-2B-M32	19340160547
M40	HV16B-SEH-2B-M40	19340160548
PG21	HV16B-SEH-2B-PG21	09340160540
PG29	HV16B-SEH-2B-PG29	09340160541

上壳 顶出线 Hoods, top entry

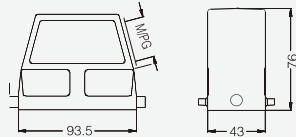
螺纹 Thread	型号 Type	订货号 Part Number
M25	HV16B-TE-2B-M25	19340161441
M32	HV16B-TE-2B-M32	19340161442
PG21	HV16B-TE-2B-PG21	09340161440

上壳 顶出线 高结构 Hoods, top entry, high construction

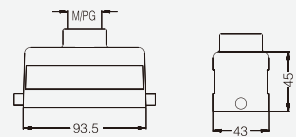
螺纹 Thread	型号 Type	订货号 Part Number
M32	HV16B-TEH-2B-M32	19340160447
M40	HV16B-TEH-2B-M40	19340160448
PG21	HV16B-TEH-2B-PG21	09340160440
PG29	HV16B-TEH-2B-PG29	09340160441

飞线下壳 Housings, cable to cable

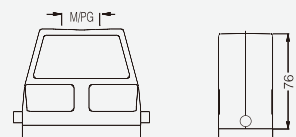
螺纹 Thread	型号 Type	订货号 Part Number
M25	HV16B-CCT-1-M25	19340161751
M32	HV16B-CCT-1-M32	19340161752
PG21	HV16B-CCT-1L-PG21	09340161750

飞线下壳 高结构 Housings, cable to cable, high construction

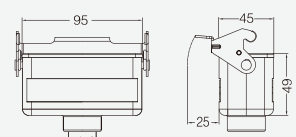
螺纹 Thread	型号 Type	订货号 Part Number
M25	HV16B-CCTH-1L-M32	19340160757
M40	HV16B-CCTH-1L-M40	19340160758
PG21	HV16B-CCTH-1L-PG21	09340160750
PG29	HV16B-CCTH-1L-PG29	09340160751

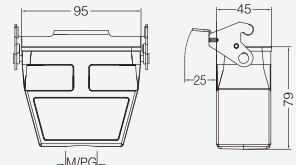

**Global District Limited**

**HV16B 金属外壳 适用高压插芯(HVE系列) Metal Hoods & Housings For HighVoltage Inserts(HVE Series)**

**防护等级 Degree of protection : IP65**

不封底下壳 Housings, bulkhead mounting



螺纹 Thread	型号 Type	订货号 Part Number
---	HV16B-BK-1L	09340160307
	带塑料盖With Plastic Cover	
---	HV16B-BK-1L-CV	09340160306
	带金属盖With Metal Cover	
---	HV16B-BK-1L-MCV	09340160318

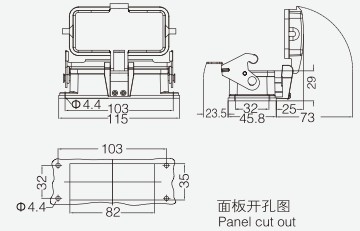

封底下壳 Housings, surface mounting



螺纹 Thread	型号 Type	订货号 Part Number
M25	HV16B-SF-1L-M25	19340161251
2M25	HV16B-SF-1L-2M25	19340161291
PG21	HV16B-SF-1L-PG21	09340161250
2PG21	HV16B-SF-1L-2PG21	09340161290
	带塑料盖With Plastic Cover	
M25	HV16B-SF-1L-CV-M25	19340161256
2M25	HV16B-SF-1L-CV-2M25	19340161296
PG21	HV16B-SF-1L-CV-PG21	09340161255
2PG21	HV16B-SF-1L-CV-2PG21	09340161295
	带金属盖With Metal Cover	
M25	HV16B-SF-1L-MCV-M25	19340162256
2M25	HV16B-SF-1L-MCV-2M25	19340162296
PG21	HV16B-SF-1L-MCV-PG21	09340162255
2PG21	HV16B-SF-1L-MCV-2PG21	09340162295

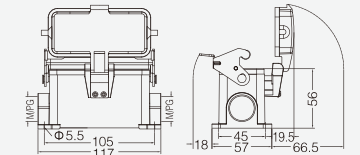

封底下壳 高结构 Housings, surface mounting, high construction



螺纹 Thread	型号 Type	订货号 Part Number
M32	HV16B-SFH-1L-M32	19340160252
2M25	HV16B-SFH-1L-2M25	19340160291
2M32	HV16B-SFH-1L-2M32	19340160292
PG21	HV16B-SFH-1L-PG21	09340160250
2PG21	HV16B-SFH-1L-2PG21	09340160290
PG29	HV16B-SFH-1L-PG29	09340160251
2PG29	HV16B-SFH-1L-2PG29	09340160291
	带塑料盖With Plastic Cover	
M32	HV16B-SFH-1L-CV-M32	19340160257
2M32	HV16B-SFH-1L-CV-2M32	19340160297
PG21	HV16B-SFH-1L-CV-PG21	09340160255
2PG21	HV16B-SFH-1L-CV-2PG21	09340160295
PG29	HV16B-SFH-1L-CV-PG29	09340160256
2PG29	HV16B-SFH-1L-CV-2PG29	09340160296
	带金属盖With Metal Cover	
M32	HV16B-SFH-1L-MCV-M32	19340167257
2M32	HV16B-SFH-1L-MCV-2M32	19340167297
PG21	HV16B-SFH-1L-MCV-PG21	09340162257
2PG21	HV16B-SFH-1L-MCV-2PG21	09340162297
PG29	HV16B-SFH-1L-MCV-PG29	09340162258
2PG29	HV16B-SFH-1L-MCV-2PG29	09340162298

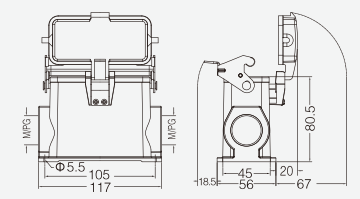



**Global District Limited**

**HV16B 金属外壳 适用高压插芯(HVE系列) Metal Hoods & Housings For High Voltage Inserts(HVE Series)**

防护等级 Degree of protection : IP65

上壳 侧出线 Hoods, side entry



螺纹 Thread	型号 Type	订货号 Part Number
M25	HV16B-SE-4B-M25	19340160521
M32	HV16B-SE-4B-M32	19340160522
PG21	HV16B-SE-4B-PG21	09340160522

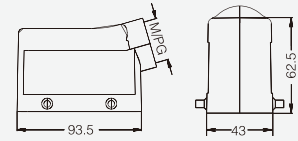

上壳 侧出线 高结构 Hoods, side entry, high construction



螺纹 Thread	型号 Type	订货号 Part Number
M32	HV16B-SEH-4B-M32	19340160552
M40	HV16B-SEH-4B-M40	19340160553
PG21	HV16B-SEH-4B-PG21	09340160552
PG29	HV16B-SEH-4B-PG29	09340160553

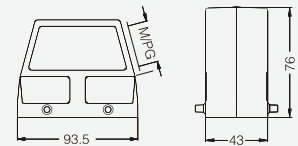

上壳 顶出线 Hoods, top entry



螺纹 Thread	型号 Type	订货号 Part Number
M25	HV16B-TE-4B-M25	19340160421
PG21	HV16B-TE-4B-PG21	19340160422

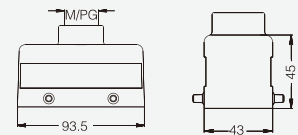

上壳 顶出线 高结构 Hoods, top entry, high construction



螺纹 Thread	型号 Type	订货号 Part Number
M32	HV16B-TEH-4B-M32	19340160452
M40	HV16B-TEH-4B-M40	19340160453
PG21	HV16B-TEH-4B-PG21	09340160452
PG29	HV16B-TEH-4B-PG29	09340160453

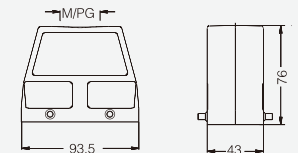

不封底下壳 Housings, bulkhead mounting



螺纹 Thread	型号 Type	订货号 Part Number
---	HV16B-BK-2L	09340160301

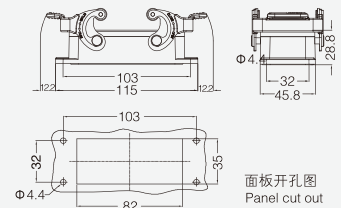

封底下壳 Housings, surface mounting



螺纹 Thread	型号 Type	订货号 Part Number
M25	HV16B-SF-2L-M25	19340160271
2M25	HV16B-SF-2L-2M25	19340160275
PG21	HV16B-SF-2L-PG21	09340160272
2PG21	HV16B-SF-2L-2PG21	09340160276

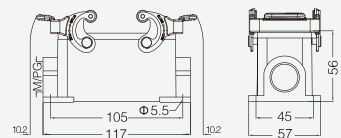



**Global District Limited**

**HV16B 金属外壳 适用高压插芯(HVE系列) Metal Hoods & Housings For High Voltage Inserts(HVE Series)**

**防护等级 Degree of protection : IP65**

封底下壳 高结构 Housings, surface mounting, high construction



螺纹 Thread	型号 Type	订货号 Part Number
M32	HV16B-SFH-2L-M32	19340160232
2M32	HV16B-SFH-2L-2M32	19340160272
PG21	HV16B-SFH-2L-PG21	09340160230
2PG21	HV16B-SFH-2L-2PG21	09340160270
PG29	HV16B-SFH-2L-PG29	09340160231
2PG29	HV16B-SFH-2L-2PG29	09340160271

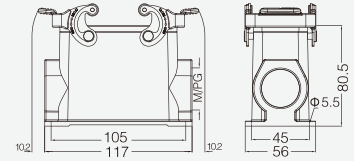

飞线下壳 Housings, cable to cable



螺纹 Thread	型号 Type	订货号 Part Number
M25	HV16B-CCT-2L-M25	19340160731
M32	HV16B-CCT-2L-M32	19340160732
PG21	HV16B-CCT-2L-PG21	09340160732

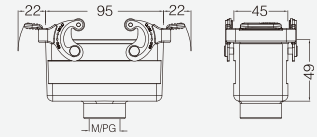

飞线下壳 高结构 Housings, cable to cable, high construction



螺纹 Thread	型号 Type	订货号 Part Number
M32	HV16B-CCTH-2L-M32	19340160737
M40	HV16B-CCTH-2L-M40	19340160738
PG21	HV16B-CCTH-2L-PG21	09340160730
PG29	HV16B-CCTH-2L-PG29	09340160731

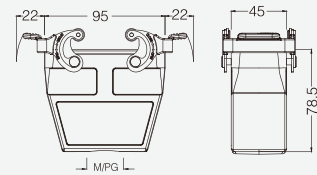

塑料防护盖 4卡扣 Protection covers, plastic



接线方式 Connect way	描述 Applications	型号 Type	订货号 Part Number
---	用于上壳 For hoods	H16B-CV-4C	09300165401

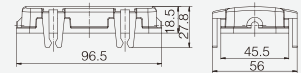

塑料防护盖 Protection covers, plastic



接线方式 Connect way	描述 Applications	型号 Type	订货号 Part Number
	塑料盖/用于飞线下壳 For Housings, cable to cable	H16B-CV-4B/1	09300165427
	塑料盖/用于不封底,封底下壳 For housing, bulkhead/ surface mounting	H16B-CV-4B/2	09300165428

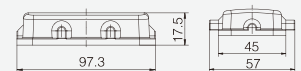



**Global District Limited**

**HV16B 金属外壳 适用高压插芯(HVE系列) Metal Hoods & Housings For High Voltage Inserts(HVE Series)**

**防护等级 Degree of protection : IP65**

上壳 侧出线 Hoods, side entry



螺纹 Thread	型号 Type	订货号 Part Number
M25	HV16B-SE-2L-M25	19340161531
M32	HV16B-SE-2L-M32	19340161532
PG21	HV16B-SE-2L-PG21	09340161530

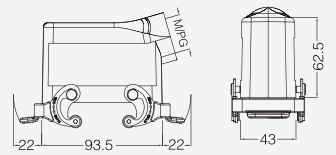

上壳 侧出线 高结构 Hoods, side entry, high construction



螺纹 Thread	型号 Type	订货号 Part Number
M32	HV16B-SEH-2L-M32	19340160537
M40	HV16B-SEH-2L-M40	19340160538
PG21	HV16B-SEH-2L-PG21	09340160530
PG29	HV16B-SEH-2L-PG29	09340160531

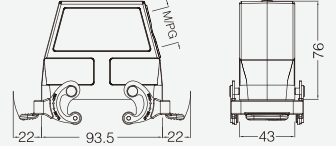

上壳 顶出线 Hoods, top entry



螺纹 Thread	型号 Type	订货号 Part Number
M25	HV16B-TE-2L-M25	19340161431
M32	HV16B-TE-2L-M32	19340161432
PG21	HV16B-TE-2L-PG21	09340161430

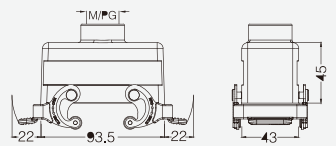

上壳 顶出线 高结构 Hoods, top entry, high construction



螺纹 Thread	型号 Type	订货号 Part Number
M32	HV16B-TEH-2L-M32	19340160437
M40	HV16B-TEH-2L-M40	19340160438
PG21	HV16B-TEH-2L-PG21	09340160430
PG29	HV16B-TEH-2L-PG29	09340160431

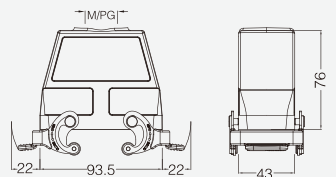

不封底下壳 Housings, bulkhead mounting



螺纹 Thread	型号 Type	订货号 Part Number
---	HV16B-BK-4B	09340160300
---	带塑料盖with plastic cover	
---	HV16B-BK-4B-CV	09340160302
---	带金属盖with metal cover	
---	HV16B-BK-4B-MCV	09340160317

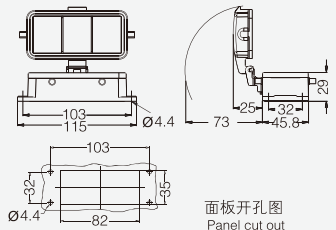



**Global District Limited**

**HV16B 金属外壳 适用高压插芯(HVE系列) Metal Hoods & Housings For HighVoltage Inserts(HVE Series)**

**防护等级 Degree of protection : IP65**

封底下壳 Housings, surface mounting



螺纹 Thread	型号 Type	订货号 Part Number
M25	HV16B-SF-4B-M25	19340161126
2M25	HV16B-SF-4B-2M25	19340161166
PG21	HV16B-SF-4B-PG21	09340161120
2PG21	HV16B-SF-4B-2PG21	09340161160
	带塑料盖 With Plastic Cover	
M25	HV16B-SF-4B-CV-M25	19340161226
2M25	HV16B-SF-4B-CV-2M25	19340161266
PG21	HV16B-SF-4B-CV-PG21	09340161220
2PG21	HV16B-SF-4B-CV-2PG21	09340161260
	带金属盖 With Metal Cover	
M25	HV16B-SF-4B-MCV-M25	19340162226
2M25	HV16B-SF-4B-MCV-2M25	19340162266
PG21	HV16B-SF-4B-MCV-PG21	09340162220
2PG21	HV16B-SF-4B-MCV-2PG21	09340162260

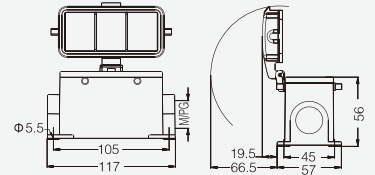

封底下壳 高结构 Housings, surface mounting, high construction



螺纹 Thread	型号 Type	订货号 Part Number
M32	HV16B-SFH-4B-M32	19340160127
2M32	HV16B-SFH-4B-2M32	19340160167
PG21	HV16B-SFH-4B-PG21	09340160120
2PG21	HV16B-SFH-4B-2PG21	09340160160
PG29	HV16B-SFH-4B-PG29	09340160121
2PG29	HV16B-SFH-4B-2PG29	09340160161
	带塑料盖 With Plastic Cover	
M32	HV16B-SFH-4B-CV-M32	19340160227
2M32	HV16B-SFH-4B-CV-2M32	19340160267
PG21	HV16B-SFH-4B-CV-PG21	09340160220
2PG21	HV16B-SFH-4B-CV-2PG21	09340160260
PG29	HV16B-SFH-4B-CV-PG29	09340160221
2PG29	HV16B-SFH-4B-CV-2PG29	09340160261
	带金属盖 With Metal Cover	
M32	HV16B-SFH-4B-MCV-M32	19340160327
2M32	HV16B-SFH-4B-MCV-2M32	19340160367
PG21	HV16B-SFH-4B-MCV-PG21	09340160320
2PG21	HV16B-SFH-4B-MCV-2PG21	09340160360
PG29	HV16B-SFH-4B-MCV-PG29	09340160321
2PG29	HV16B-SFH-4B-MCV-2PG29	09340160361

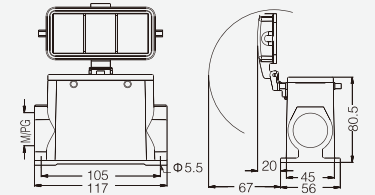

防护盖 Protection covers, metal



接线方式 Connect way	描述 Applications	型号 Type	订货号 Part Number
	金属保护盖/用于上壳 For hoods	H16B-MCV-4B/1	09340165426
	金属保护盖/用于下壳 For housings	H16B-MCV-4B/2	09340165425

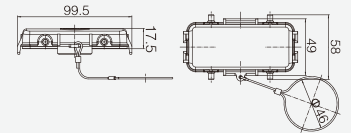

防护盖 Protection covers, metal



接线方式 Connect way	描述 Applications	型号 Type	订货号 Part Number
	金属保护盖/用于上壳 For hoods	H16B-MCV-2L.1S	09340165422
	金属保护盖/用于下壳 For housings	H16B-MCV-2L.2S	09340165423

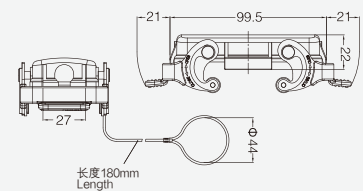



**Global District Limited**

**HV16B 金属外壳 适用高压插芯(HVE系列) Metal Hoods & Housings For High Voltage Inserts(HVE Series)**

**防护等级 Degree of protection : IP65**

上壳 侧出线 高结构 Hoods, side entry, high construction



螺纹 Thread	型号 Type	订货号 Part Number
M32	HV16B-SEH-1L/C-M32	19340160587
PG21	HV16B-SEH-1L/C-PG21	09340160580
PG29	HV16B-SEH-1L/C-PG29	09340160581

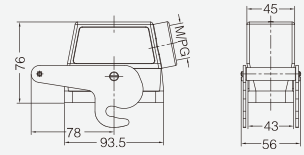

不封底下壳 Housings, bulkhead mounting



螺纹 Thread	型号 Type	订货号 Part Number
---	HV16B-BK-2B/C	09340160381

